



WAGONEER

GRAND WAGONEER

AUTOMAX
AUTOMAX - 3



R A N G E R O V E R



AUTOMAX.AE 011 231 9885



GRAND WAGONEER

AUTOMAX
AUTOMAX.COM



GRAND WAGONEER

GRAND WAGONEER

AUTOMAX
AUTOMAX 4x4 3.0 HEMI V8



GRAND WAGONEER

AUTOMAX
AUTOMAX 4x4 3.0L V6 300HP 8AT 210



GRAND WAGONEER

AUTOMAX
AUTOMAX SA 0000000000

GRAND WAGONEER







GRAND WAGONEER

AIRBAG

4. Navigation

NW

P

38°C

0

km/h

Top View

MAX

REAR

Waterfall

Lower Back

Extend

Low Extend

Rock Climb

High

Med

Low

Off

Driver

Message



GRAND V

PIONEER



SET+



CANC



RES



SET-

START
ENGINE
STOP

— GEAR +
LIMIT



0

km/h

أولادنا

4. Navigation

P

38°C

2 St Eet

Manama Street



AERO



1. Driver Info



Hold OK for Digital

0

km/h

Press OK for MPH

Speedometer
0 100 200

P

38°C



5. Off Road

P

38°C

E



AUTO

Automatic Full

Time 4WD

Adapts to

Road Conditions



AERO

Improved
Aerodynamics



H



C



Terrain Status



E



F



AERO



5. Off Road

P

38°C

E

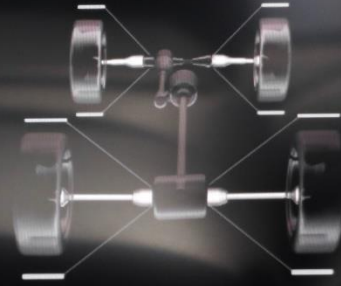
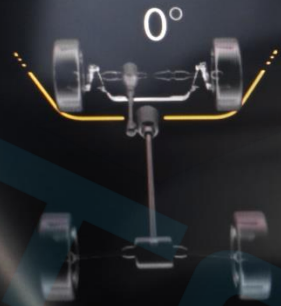

AERO

H



◀

Vehicle Dynamics

▶

E



1. Driver Info

P

38°C

E



Driver Assist
Press OK to Zoom Out





Top View

Rear View

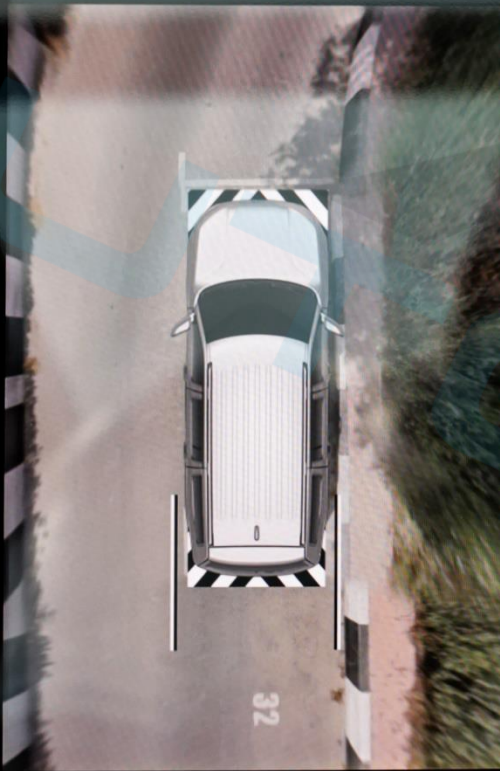

Select a seat to change zoom view



TUNE/
SCROLL



AUTO

A/C





LO | 12:10 DUBAI | LO

Front Seats Massage Rear

Front Defrost

Heat

Vent

Max A/C

A/C

Max

Rear

Heat

Vent

Sync Off < 1 2 3 4 5 6 7 > Auto

ZONE

Heat

Vent

ZONE

Heat

Vent

VOL

TUNE/SCROLL

START ENGINE STOP

LO 12:11 -DUBAI LO

Off Road **Controls** Settings

Mirror Dimmer	2nd Row Headrest Fold	3rd Row Headrest Fold
Pass Screen Screen Off	Pass Screen Power Off	Power Side Step
Surround Camera	FamCam	Rear View Camera



Vehicle

TUNE/SCROLL

MAX REAR OFF AUTO A/C

Vehicle Dynamics

Accessory Gauges

Pitch & Roll

Selec-Terrain

Suspension

Steering Angle: 0°

Transfer Case: Unlocked

Rear Axle Locker: Unlocked

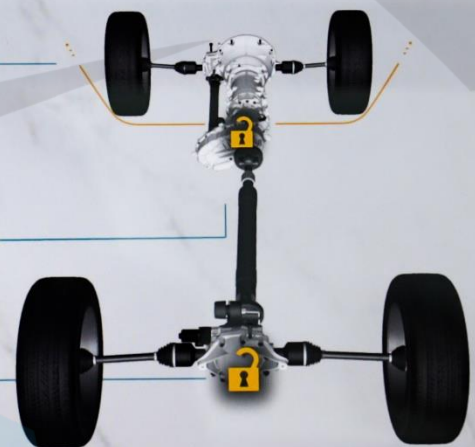

4WD HIGH 55°21'60" E 25°10'07" N Altitude 9 m SPORT

Favorites All

Media

Comfort

Nav

Phone

AM

AM Radio

Audio Settings

Auxiliary Cable

Bluetooth

DAB

DAB

Device Manager

FM

FM Radio

Media



NW



Apps

START
ENGINE
STOP

TUNE
CROLL

Favorites

All

Media

Comfort

Nav

Phone



Comfort



Driver Heat



Driver Vent



Heated Wheel



Massage Seats



Psgr Heat



Psgr Vent



NW
▲



Apps



LO | 12:13 FM- | LO

Favorites All

^

Phone

Vehicle

System

Other

^

☆ Ambient Color

☆ Audio Settings

☆ Controls

☆ FamCam

☆ Mirror Dimmer

★ Off Road Pages

☆ Rear View Camera

☆ Select. Tire Fill Alert

v



NW
▲

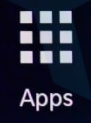

Apps

Favorites All

^

Phone

Vehicle

System

Other

^

Settings

Surround Camera

Vehicle

2nd Row Headrest...

3rd Row Headrest...

v

ZONE

ZONE

ZONE









VOL

ZONE

ZONE

ZONE

TUNE/SCROLL

LO      | 12:13  FM- |   LO



Favorites All



Phone



Vehicle

System

Other

 Driver Profiles 

 Software Updates 

 Stored No-tifications 

       Apps

TUNE/SCROLL 

START ENGINE TOP 

LO | | 12:13 FM- | LO

Favorites All

^

Phone	☆	☆	☆
Vehicle	McIntosh	Relax	Tutorials
System			
Other			

v

NW Apps

START
ENGINE
STOP

ZONE

TUNE
SCROLL

LO 12:13 FM -DUBAI LO

Ambient Color Personalization



Sync



Vehicle



LO | 12:10 | LO

Sources **Playing** Browse Audio Settings

FM- TP FM

FM- DAB

All Presets | 1 Hold to Save | 2 Hold to Save | 3 Hold to Save | 4 Hold to Save | 5 Hold to Save | 6 Hold to Save | >



NW
A



TUNE/
SCROLL



Вид сверху

Вид сзади

32



TUNE/
SCROLL



START
ENGINE
STOP



AUTO

A/C



Низ. 12:14 FM -DUBAI Низ.

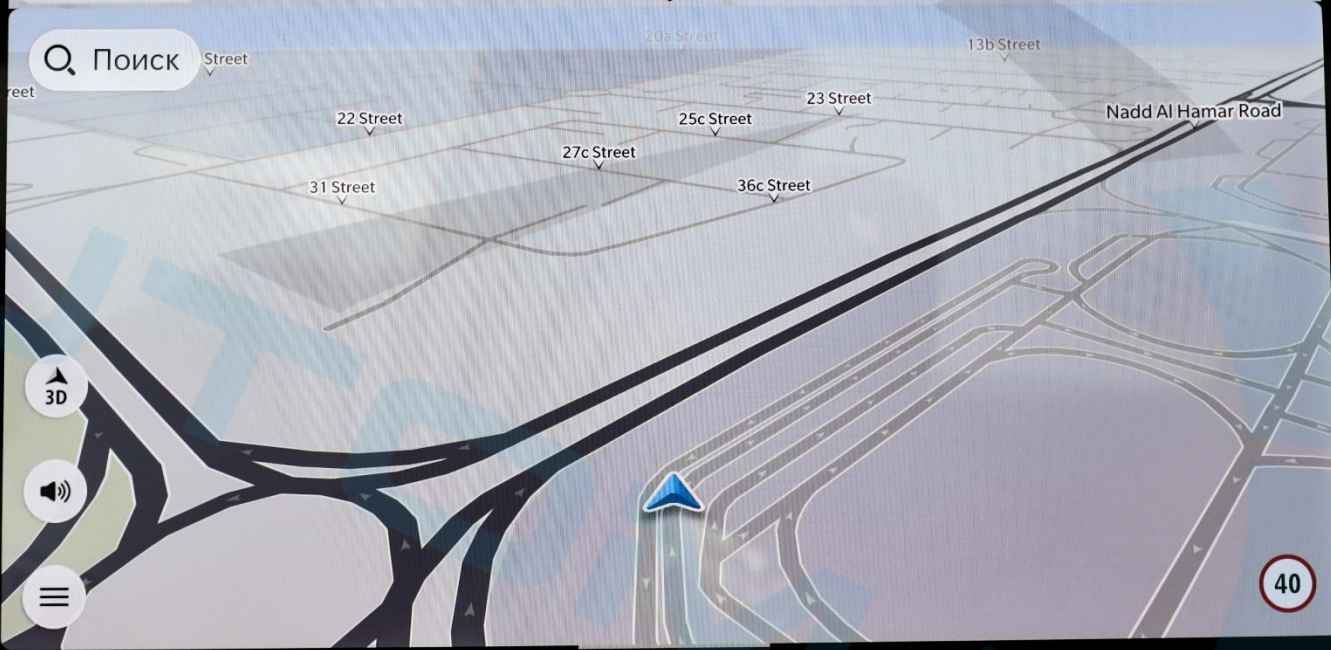

3D
Speaker icon
Menu icon

40

C3
A
Nav



Home icon, Music icon, Phone icon, Car icon, Grid icon, Power icon, TUNE/SCROLL knob

MAX, REAR, OFF, AUTO, A/C, Fan icon

Избранные Все

Медиа	☆	☆	☆	☆
Comfort	Вент. водит.	Вент. пасс.	Комфорт	Обог. пасс.
Nav	☆	☆	☆	
Тел.	Обог. водит.	Обогрев. рул. кол...	Сиденья с массаж...	



Низ. 12:14 FM FM- Низ.

Бездорожье | **Элементы управления** | Настройки

Затем. зер. зад. вида	Склад. подгол. 2 ряда	Склад. подгол. 3 ряда
Экран пассажира Пит. выкл.	Экран пассажира Питание выкл.	Power Side Step
Кам. круг. обзора	FamCam	Камера зад. вида



C3

AUTO A/C

**Динамика
автомобиля**

Вспомог.
приборы

Попер.
перемещения

Selec-Terrain

Подвески

Угол поворота
рулевого колеса:
0°

Раздаточная
коробка:
Разблокирована

Блокиратор
заднего моста:
Разблокирована

**4WD
HIGH** 55°21'60" В 25°10'07" С Высота 9 м

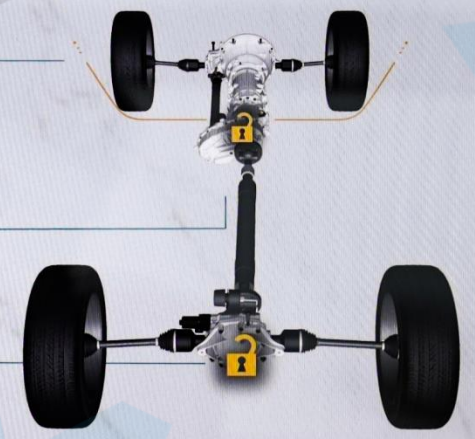

SPORT





الرؤية الخلفية

الرؤية العلوية

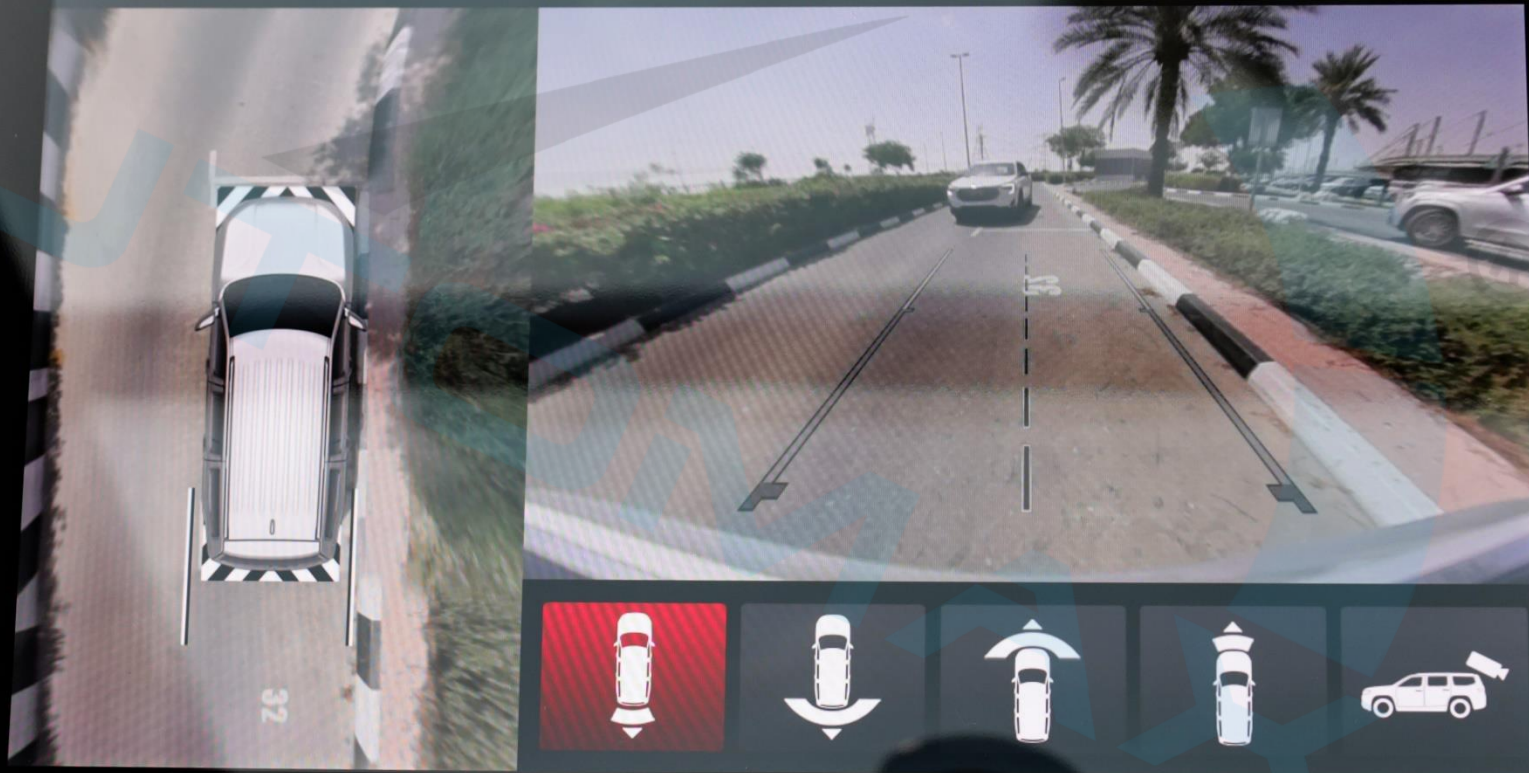

TUNE/
SCROLL



VOL



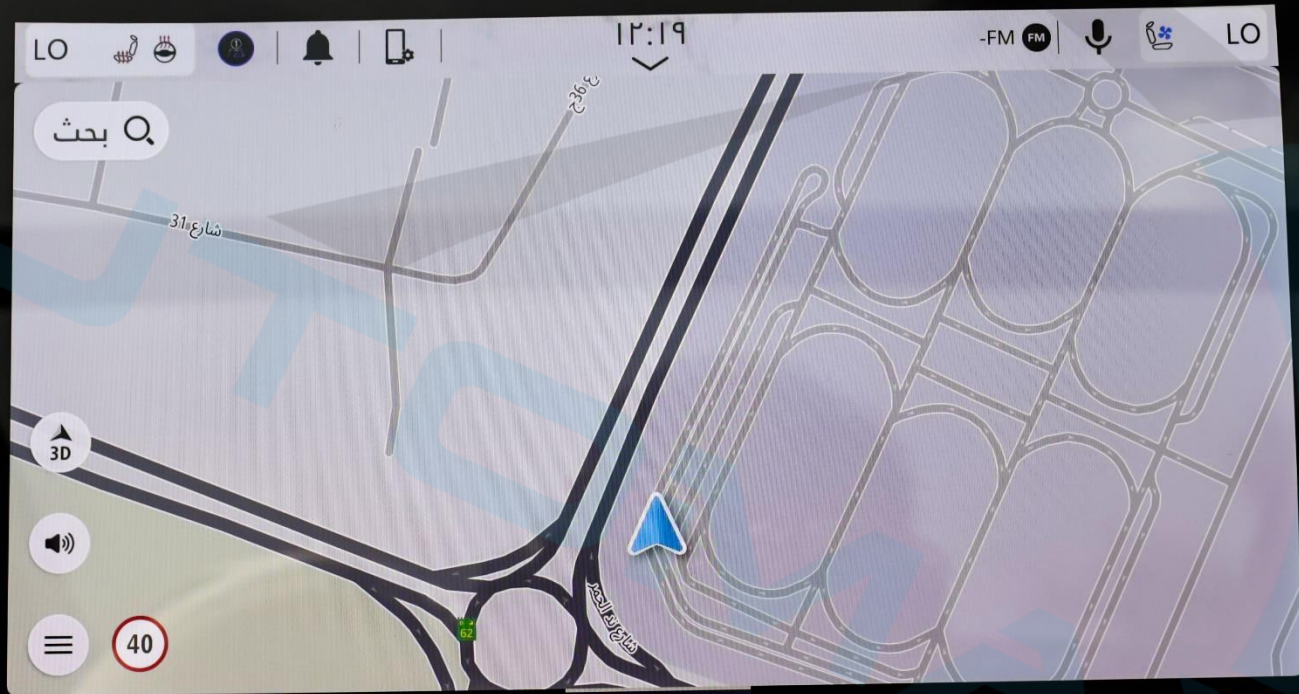

بحث 🔍

12:19

-FM FM

LO

3D

🔊

☰

40

NW

▲

Nav

TUNE/

SCROLL



VOL

↑ ↓

⏪

⏩

MAX

REAR

OFF

OFF

AUTO

A/C

🚗

⏪

⏩

LO

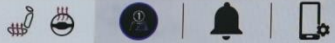

12:14

DUBAI- FM

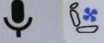

LO

الجميع

المفضلة



تهوية الراكب



تدفئة السائق



تدفئة الراكب



الراحة



مقود مدفأ

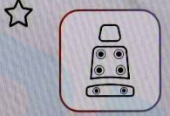

مقاعد التدليك



تهوية السائق

الوسائط

مريح

الملاحة

الهاتف

التطبيقات



NW



TUNE/SCROLL



AUTO

A/C





أراض وعرة

متحكمات

إعدادات

طي مسند
الرأس للصف
الثالث 

طي مسند
الرأس للصف
الثاني 

معتم المرأة 

Power Side
Step 

إيقاف
تشغيل
شاشة
الراكب 

شاشة
الراكب
مطفأة 

كاميرا الرؤية
الخلفية 

FamCam 

كاميرا الرؤية
المحيطية 



NW
A



TUNE/
SCROLL



LO



١٢:١٦

DUBAI- FM



LO

ديناميكيات
المركبة

ملحقات
المقاييس

انحدار و
التفاف

Selec-Terrain

نظام التعليق

زاوية التوجيه:
0°

حالة النقل:
غير مغلق

قفل المحور
الخلفي:
غير مغلق

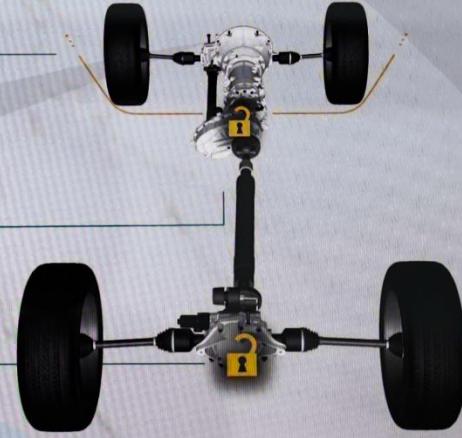

4WD
HIGH

55°21'60" E

25°10'07" N

ارتفاع 9 m

SPORT



المركبة



NW
A



TUNE/
SCROLL



AUTO

A/C



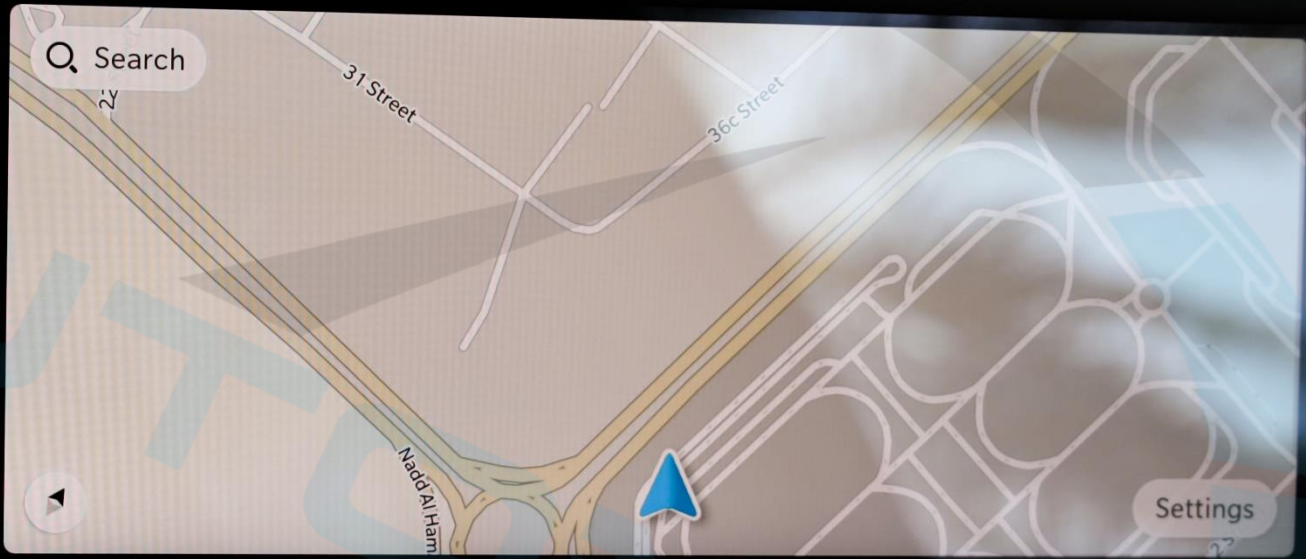

Home

Controls

G R A N D W A G O N E

Home



Controls

Audio



FM

AM

Bluetooth

More...

Video



USB 1

USB 2

More...

HDMI



HDMI
HIGH DEFINITION MULTIMEDIA INTERFACE

Connect HDMI Cable

GRAND WAGON



VOL ↑ ↓

TUNE SCROLL ↑ ↓

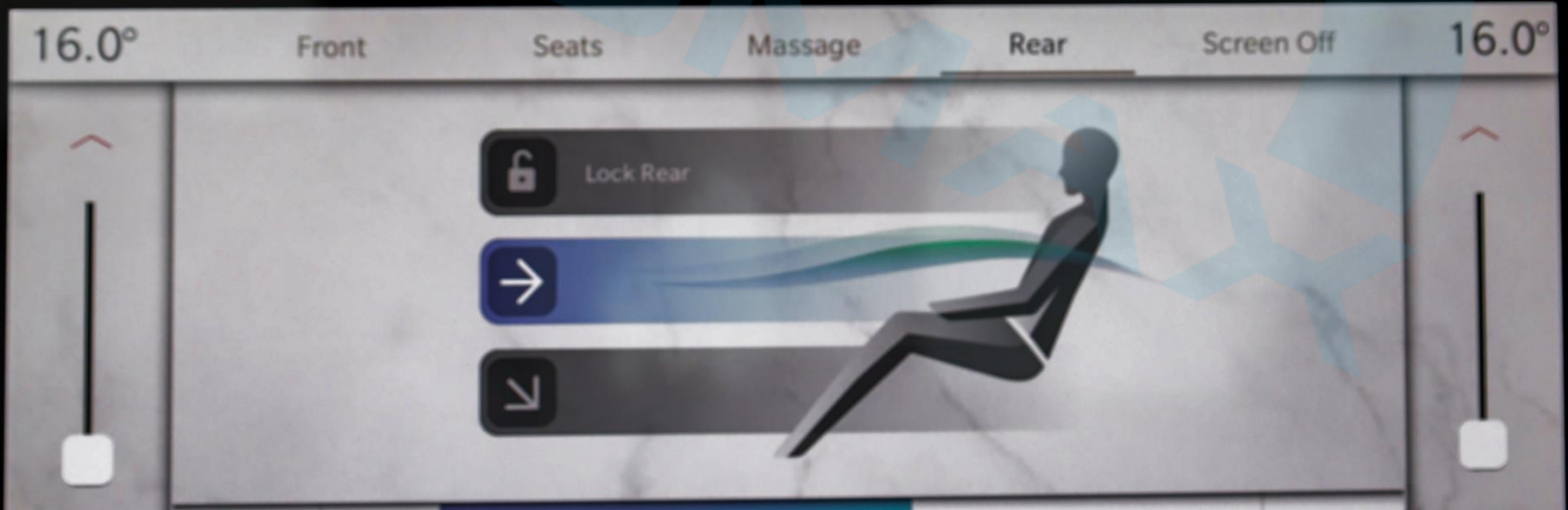

16.0°

Front

Seats

Massage

Rear

Screen Off

16.0°

Lock Rear



AUTO

A/C



Front Seats Massage Rear Screen Off

Waterfall	High	<p>Driver</p>	<p>Passenger</p>	High	Waterfall
Lower Back	Med			Med	Lower Back
Extend	Low			Low	Extend
Low Extend	Off			Off	Low Extend
Rock Climb					Rock Climb



MUTE



AUTO HOLD ON



OFF



OFF



ON



OFF



TOW/HAUL ON



OFF

ROCK SAND/AID



AUTO

A/C



Front	Seats	Massage	Rear	Screen Off
<div data-bbox="547 464 649 564">-</div> <div data-bbox="649 478 777 549">Lumbar Up/Down</div> <div data-bbox="777 464 879 564">+</div>	<div data-bbox="955 471 1261 849"></div> <div data-bbox="1031 892 1133 928">Driver</div>	<div data-bbox="1363 471 1668 849"></div> <div data-bbox="1465 892 1617 928">Passenger</div>	<div data-bbox="1732 464 1834 564">-</div> <div data-bbox="1834 478 1961 549">Lumbar Up/Down</div> <div data-bbox="1961 464 2063 564">+</div>	<div data-bbox="1732 464 1834 564">-</div> <div data-bbox="1834 478 1961 549">Lumbar Up/Down</div> <div data-bbox="1961 464 2063 564">+</div>
<div data-bbox="547 578 649 678">-</div> <div data-bbox="649 592 777 664">Lumbar In/Out</div> <div data-bbox="777 578 879 678">+</div>			<div data-bbox="1732 578 1834 678">-</div> <div data-bbox="1834 592 1961 664">Lumbar In/Out</div> <div data-bbox="1961 578 2063 678">+</div>	<div data-bbox="1732 578 1834 678">-</div> <div data-bbox="1834 592 1961 664">Lumbar In/Out</div> <div data-bbox="1961 578 2063 678">+</div>
<div data-bbox="547 699 649 799">-</div> <div data-bbox="649 714 777 785">Back Bolster</div> <div data-bbox="777 699 879 799">+</div>			<div data-bbox="1732 699 1834 799">-</div> <div data-bbox="1834 714 1961 785">Back Bolster</div> <div data-bbox="1961 699 2063 799">+</div>	<div data-bbox="1732 699 1834 799">-</div> <div data-bbox="1834 714 1961 785">Back Bolster</div> <div data-bbox="1961 699 2063 799">+</div>
<div data-bbox="547 821 649 921">-</div> <div data-bbox="649 835 777 906">Thigh Bolster</div> <div data-bbox="777 821 879 921">+</div>			<div data-bbox="1732 821 1834 921">-</div> <div data-bbox="1834 835 1961 906">Thigh Bolster</div> <div data-bbox="1961 821 2063 921">+</div>	<div data-bbox="1732 821 1834 921">-</div> <div data-bbox="1834 835 1961 906">Thigh Bolster</div> <div data-bbox="1961 821 2063 921">+</div>



MUTE



AUTO HOLD ON



TOW/HAUL ON



ROCK SAND/MUD

Extend Low Off Driver Passenger Low Off Extend Low Extend Rock Climb

Driver Passenger

MUTE OFF AUTO HOLD ON OFF OFF ON OFF TOW/HAIL ON

ROCK SAND/MUD SNOW AUTO SPORT

PRND

4WD LOW



MAX REAR AUTO A/C TUNE/SCROLL

Front Seats Massage Rear Screen Off

Waterfall	High	Driver	Passenger	High	Waterfall
Lower Back	Med			Med	Lower Back
Extend	Low			Low	Extend
Low Extend					Low Extend
Rock Climb	Off			Off	Rock Climb

4WD LOW

4WD LOW

4WD LOW



1



AUX



2



HDMI
PASSENGER











LO Rear Comfort Screen Off LO

Rear Lock

→

↓

1 2 3 4 5 6 Auto









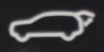

OPEN
AUTO
CLOSE

TILT
VENT
DOWN

OPEN
AUTO
CLOSE





2L

2R

3L

3R



12V DC

A horizontal row of controls on a dark leather dashboard. From left to right: a circular rotary knob for lighting, two small cylindrical buttons for fog lights, and a rectangular button for wipers. Above the rotary knob is a horizontal grille.

AUTO



PULL ON





۰۰۰۰۰

-

+

1

ADJUST

2

McIntosh









ALFA ROMEO

ALL INFORMATION CONTAINED HEREIN IS UNCLASSIFIED

OP:810 SEQ:370320
PS532903 68400498AA





GRAND WAGONEER

BEST



TIRE COMPRESSOR



PULL







GRA

BRIDGESTONE

DUELER H/T

JAGUAR





لمشاهدة صورة السيارة بزاوية 360 درجة إضغط على الصورة أعلاه

Для просмотра автомобиля в формате 360°, пожалуйста, нажмите на фото выше.

To view the 360° degree please press on the picture above

2023 JEEP GRAND WAGONEER SERIES II 16 3.0L TT 4X4 GCC 0Km

Бренд: Jeep

Brand: Jeep

الماركة: جيب

Категория: GRAND WAGONEER

Category: GRAND WAGONEER

الفئة: GRAND WAGONEER

Модель: SERIES II LUXURY

Model: SERIES II LUXURY

الموديل: SERIES II LUXURY

Год: 2023

Year: 2023

السنة: 2023

Километров: 0 Km

Kilometers: 0 Km

كيلومترات: 0 كم

Двери: 4 Doors

Doors: 4 Doors

عدد الأبواب: 4 أبواب

Цвет: Серый

Color: Baltic Grey

اللون: رمادي

Цилиндр: 6

Cylinder: 6 Cylinders

عدد الأسطوانات: 6 أسطوانات

Лошадиные силы: 510 HP

Horsepower: 510 HP

عدد الأحصنة: 510 حصان

Трансмиссия: Автоматическая

Transmission: Automatic

نوع النقل: نقل أوتوماتيكي

Топливо: Бензин

Fuel: Gasoline

نوع الوقود: بنزين

4X4

4X4

المواصفات خليجية
4X4

2023 JEEP GRAND WAGONEER SERIES II 16 3.0L TT 4X4 GCC 0Km

LEATHER TRIMMED BUCKET SEATS
GLOBAL BLACK
MIDDLE EAST EQUIPMENT GROUP
OFF ROAD GROUP II
MONOTONE PAINT
AUX BATTERY
REMOVABLE ASH TRAY
8-SPD AUTO 8HP75 TRANS (BUY-US)
3.0L 16 HURRICANE HO TWIN TURBO ESS
AUTO DIM EXTERIOR DRIVER MIRROR
CIGAR LIGHTER
GPS NAVIGATION
GPS ANTENNA INPUT
ACTIVE NOISE CONTROL SYSTEM
EXT. MIRRORS W/SUPPLEMENTAL SIGNALS
EXTERIOR MIRRORS W/ARABIC LETTERING
EXTERIOR MIRRORS W/MEMORY
AUTO ADJUST IN REVERSE EXT MIRRORS
HEATED EXTERIOR MIRRORS

EXTERIOR MIRRORS APPROACH LAMPS
ROOF - BODY COLOR
QUADRA DRIVE II BADGE
U.S. EMISSIONS W/OBD 1
INTEGRATED TIRE COMPRESSOR KIT
BALTIC GREY METALLIC CLEAR COAT
ALL RADIO EQUIPPED VEHICLES
12.0" TOUCHSCREEN DISPLAY
FRONT PASSENGER INTERACTIVE DISPLAY
DIGITAL AUDIO BROADCASTING
ALL R1 HIGH RADIOS
BRIDGESTONE BRAND TIRES
ALL ALUMINUM WHEELS
FUEL TANK SKID PLATE SHIELD
TRANSFER CASE SKID PLATE SHIELD
FRONT AXLE SKID PLATE
STOP-START DUAL BATTERY SYSTEM
ARABIC LANGUAGE
10 ADDITIONAL GALLONS OF GAS

2023 JEEP GRAND WAGONEER SERIES II 16 3.0L TT 4X4 GCS OKm

Quadra Drive II

INTEGRATED TIRE COMPRESSOR KIT

ADJUSTABLE ROOF RAIL CROSSBARS

7 местный

Зимний Пакет

Gear Limit

Вентиляция Сидений

Подогрев Сидений

Сиденья с функцией массажа

Рулевое Колесо с Подогревом

Регулируемые Сиденья с Памятью Позций

Дистанционный Запуск Двигателя

Система Мониторинга Слепых Зон

Бесключевой Доступ

Регулировка Режимов Вождения

Подрулевые Лепестки

Пневмоподвеска

Дистанционное управление пневмоподвеской

Адаптивный Круиз-контроль

ДИСПЛЕЙ ДЛЯ ПАССАЖИРА

Камера Наблюдения Внутри Салона

Холодильник

Контурная Подсветка Салона

Система Экстренного Торможения

Контроль Полосы Движения

Проекция на лобовое стекло

MCINTOSH Премиальная Мультимедийная Система С 19-МИ ДИНАМИКАМИ

Камера 360 Градусов

Панорамная Крыша

Планшет

Беспроводная Зарядка

Система Помощи При Спуске с Горы

Датчик Давления в Шинах

Розетка

Задние Шторки

Система «Старт-Стоп»

Выдвижная Боковая Подножка

Автопарковка

R 20"

Apple Carplay

Android Auto

2023 JEEP GRAND WAGONEER SERIES II 16 3.0L TT 4X4 GCC 0Km

* الأداء:

ناقل حركة أوتوماتيكي ب 8 سرعات

عدد الأسطوانات: 6 أسطوانات

سعة المحرك: 3.0 توين توربو

العزم: 677 نيوتن.متر

عدد الأحصنة: 510 حصان

دفع رباعي 4X4

* المواصفات الإضافية:

Quadra Drive II

Gear Limit

INTEGRATED TIRE COMPRESSOR KIT

ADJUSTABLE ROOF RAIL CROSSBARS

7 مراتب

كاميرا بزاوية 360 درجة

شاشة بروجكتر أمامي

شاشة إضافية للمرافق

ثلاجة أمامية

تابلت للتحكم بالمقصورة الخلفية

عداد ديجيتال

مثبت السرعة التكييفي

نظام الهيدروليك لرفع و خفض المركبة مع خاصية التحكم عن بعد

نظام صوتي متقدم من MCINTOSH مع 19 سماعة

خاصية التبريد والتدفئة للمراتب

خاصية المساج للمراتب

فتحة سقف بانوراما مزدوجة

خاصية تثبيت المسار

كاميرا داخلية بزاوية 180 درجة

نظام الملاحة وتحديد المواقع

2023 JEEP GRAND WAGONEER SERIES II 16 3.0L TT 4X4 GCC 0Km

خاصية الكشف عن النقطة العمياء

أوتو بارك

دخول بصمة

خاصية تدفئة المقود

خاصية المساعدة في نزول المنحدرات

نظام البطارية المزدوجة للبدء والتوقف

خاصية التشغيل عن بعد

نظام مكابح متقدم مع الفرامل التلقائية

وضعية قيادة متعددة

مراتب كهربائية متعددة الوضعية مع خاصية الذاكرة

وحدة تكييف خلفية منفصلة

ابل كاربلاي

اندرويد أوتو

إنارة داخلية محيطيه

دبّة كهربائية مع حساس قدم

مخارج طاقة كهربائية متعددة

شاحن هاتف لاسلكي

ستائر خلفية

عتبات جانبية كهربائية

جنوط مقاس 20 بوصة

AUTOMAX®

The Boutique Of Muscle Cars, Truck Fanatics & German Automotive Experts.



نتكلم اللغة العربية

WE SPEAK ENGLISH

ON PARLE LE FRANCAIS

Nosotros hablamos español

мы говорим по-русски

biz o'zbek tilida

gaplashamiz

हम हिंदी बोलते हैं



automaxgroup.me



automax group



automax.dxb



Automax_LLC



+971 50 602 7200



automax.dxb



automax.dxb



automax.dxb



automax_dxb



automax group L.L.C

New Auto Market - Dubai - United Arab Emirates

 **Directions**