







GRAND WAGONEER

GRAND WAGONEER

AUTOMAX
AUTOMAX 33 3333 3333



GRAND WAGONEER





GRAND WAGONEER



GRAND WAGONEER







GRAND WAGONEER

AIRBAG

4. Navigation

NW

P

38°C

0 km/h

Top View



GEAR LIMIT

MAX

REAR

OFF

ON

Waterfall

Lower Back

Extend

Low Extend

Rock Climb

High

Med.

Low

Off

Seats

Massage

Driver



↑ ↓

△

☎

◀

OK

▶

🔊

▽

☎

GRAND V

PIONEER



SET+



CANC



RES



SET-

START
ENGINE
STOP



0

km/h

أولادنا

4. Navigation

2 St Eet

P

38°C

Manama Street



AERO

1. Driver Info



Hold OK for Digital

0

km/h
Press OK for MPH

Speedometer
0 100 200



38°C

AERO



5. Off Road

P

38°C

E



AUTO

AERO

Automatic Full

Improved

Time 4WD



Adapts to

Aerodynamics

Road Conditions



Terrain Status



5. Off Road

P

38°C

E

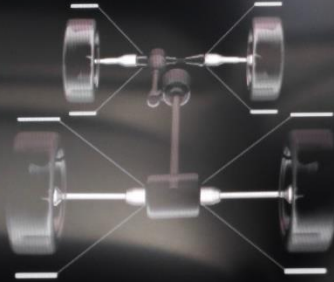
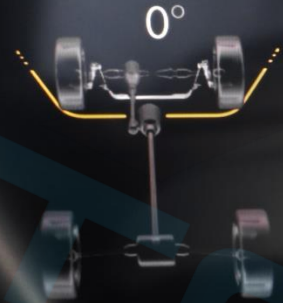

Vehicle Dynamics



1. Driver Info

P

38°C

E



Driver Assist
Press OK to Zoom Out



Top View

Rear View

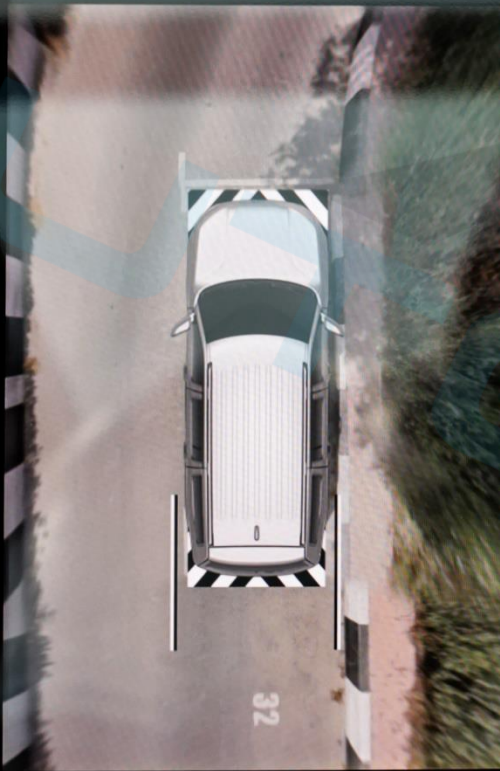

Select a seat to change zoom view



TUNE/
SCROLL



AUTO

A/C





LO [Icons] 12:10 FM DUBAI [Icons] LO

Front Seats Massage Rear

Heat
Vent

Front Defrost

Heat
Vent

Max A/C A/C Max Rear

Sync Off < 1 2 3 4 5 6 7 > Auto

VOL

TUNE/SCROLL

START ENGINE STOP

MAX REAR OFF AUTO A/C

LO 12:11 -DUBAI LO

Off Road **Controls** Settings

Mirror Dimmer	2nd Row Headrest Fold	3rd Row Headrest Fold
Pass Screen Screen Off	Pass Screen Power Off	Power Side Step
Surround Camera	FamCam	Rear View Camera



NW

AUTO A/C

Vehicle Dynamics

Accessory Gauges

Pitch & Roll

Selec-Terrain

Suspension

Steering Angle: 0°

Transfer Case: Unlocked

Rear Axle Locker: Unlocked

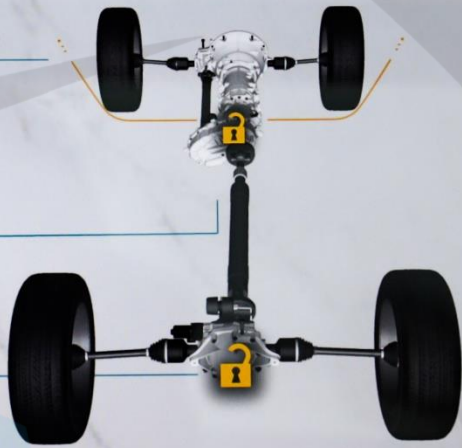

4WD HIGH 55°21'60" E 25°10'07" N Altitude 9 m SPORT

Favorites All

Media

Comfort

Nav

Phone

AM

AM Radio

Audio Settings

Auxiliary Cable

Bluetooth

DAB

DAB

Device Manager

FM

FM Radio

Media



NW



Apps

START
ENGINE
STOP

ZONE

ZONE

TUNE
CROLL

Favorites

All

Media

Comfort

Nav

Phone



Comfort



Driver Heat



Driver Vent



Heated Wheel

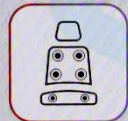

Massage Seats



Psgr Heat



Psgr Vent



NW
▲



Apps



LO | 12:13 FM- | LO

Favorites All

^

Phone

Vehicle

System

Other

^

☆ Ambient Color

☆ Audio Settings

☆ Controls

☆ FamCam

☆ Mirror Dimmer

★ Off Road Pages

☆ Rear View Camera

☆ Select. Tire Fill Alert

v



NW
▲



Apps

Favorites All

Phone

Vehicle

System

Other

Settings

Surround Camera

Vehicle

2nd Row Headrest...

3rd Row Headrest...

LO | 12:13 FM- | LO

Favorites All

Phone

Vehicle

System

Other

Driver Profiles

Software Updates

Stored No-tifications

Apps

TUNE/SCROLL

START ENGINE TOP

LO | [Phone] [Bluetooth] [Signal] | 12:13 | FM FM- | [Microphone] [Voice] LO

Favorites | All

Phone

Vehicle

System

Other

McIntosh

Relax

Tutorials

[Home] [Music] [Activity] [NW] [Phone] [Car] [Apps]

START
ENGINE
STOP

[Touchscreen] [ZONE] [Power] [TUNE] [SCROLL]

LO 12:13 FM -DUBAI LO

Ambient Color Personalization

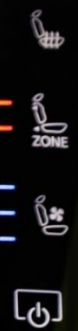

Sync



Vehicle

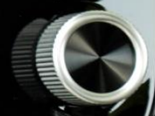

LO [Icons] 12:10 [Icons] LO

Sources **Playing** Browse Audio Settings

FM- TP FM

FM DAB

⏮ ⏪ ⏩ ⏭

All Presets | 1 Hold to Save | 2 Hold to Save | 3 Hold to Save | 4 Hold to Save | 5 Hold to Save | 6 Hold to Save | >



NW
A



TUNE/
SCROLL

⏴ ⏵ [MAX] [REAR] [Icons] [OFF] AUTO A/C [Icons]



Вид сверху

Вид сзади



Низ. 12:14 FM -DUBAI Низ.

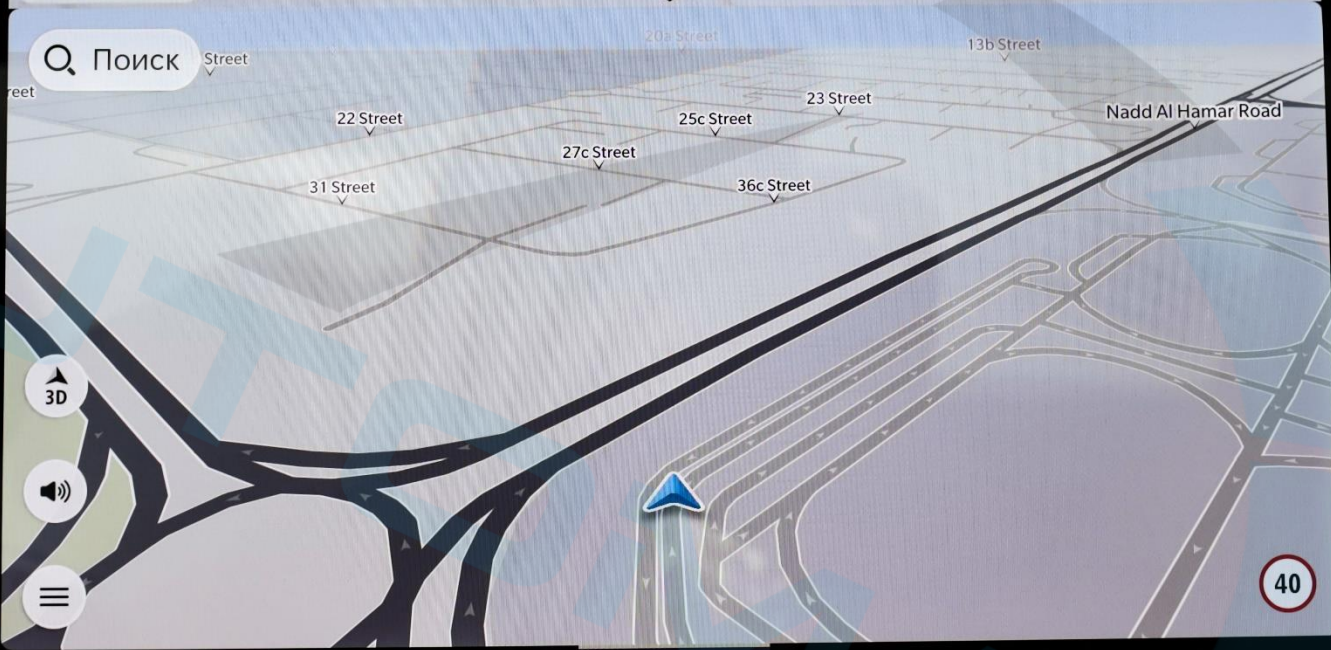

3D
Speaker icon
Menu icon

40

C3
A
Nav



Home icon, Music icon, Phone icon, Car icon, App grid icon, Power icon, TUNE/SCROLL knob

MAX, REAR, OFF, AUTO, A/C, Fan icon, Temperature controls

Избранные Все

Медиа	☆	☆	☆	☆
Comfort	Вент. водит.	Вент. пасс.	Комфорт	Обог. пасс.
Nav	☆	☆	☆	
Тел.	Обог. водит.	Обогрев. рул. кол...	Сиденья с массаж...	



Низ. | 12:14 FM- | Низ.

Бездорожье | **Элементы управления** | Настройки

Затем. зер. зад. вида	Склад. подгол. 2 ряда	Склад. подгол. 3 ряда
Экран пассажира Пит. выкл.	Экран пассажира Питание выкл.	Power Side Step
Кам. круг. обзора	FamCam	Камера зад. вида



**Динамика
автомобиля**

Вспомог.
приборы

Попер.
перемещения

Selec-Terrain

Подвески

Угол поворота
рулевого колеса:
0°

Раздаточная
коробка:
Разблокирована

Блокиратор
заднего моста:
Разблокирована

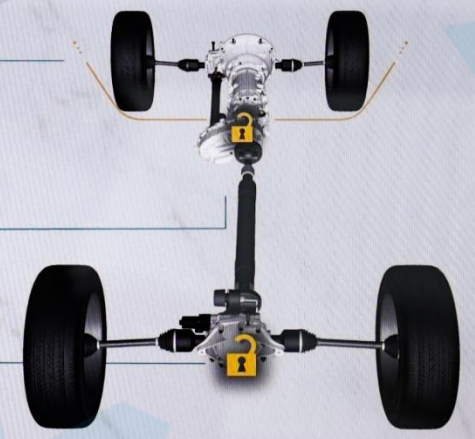

4WD HIGH 55°21'60" В 25°10'07" С Высота 9 м **SPORT**



АВТОМ.





الرؤية الخلفية

الرؤية العلوية

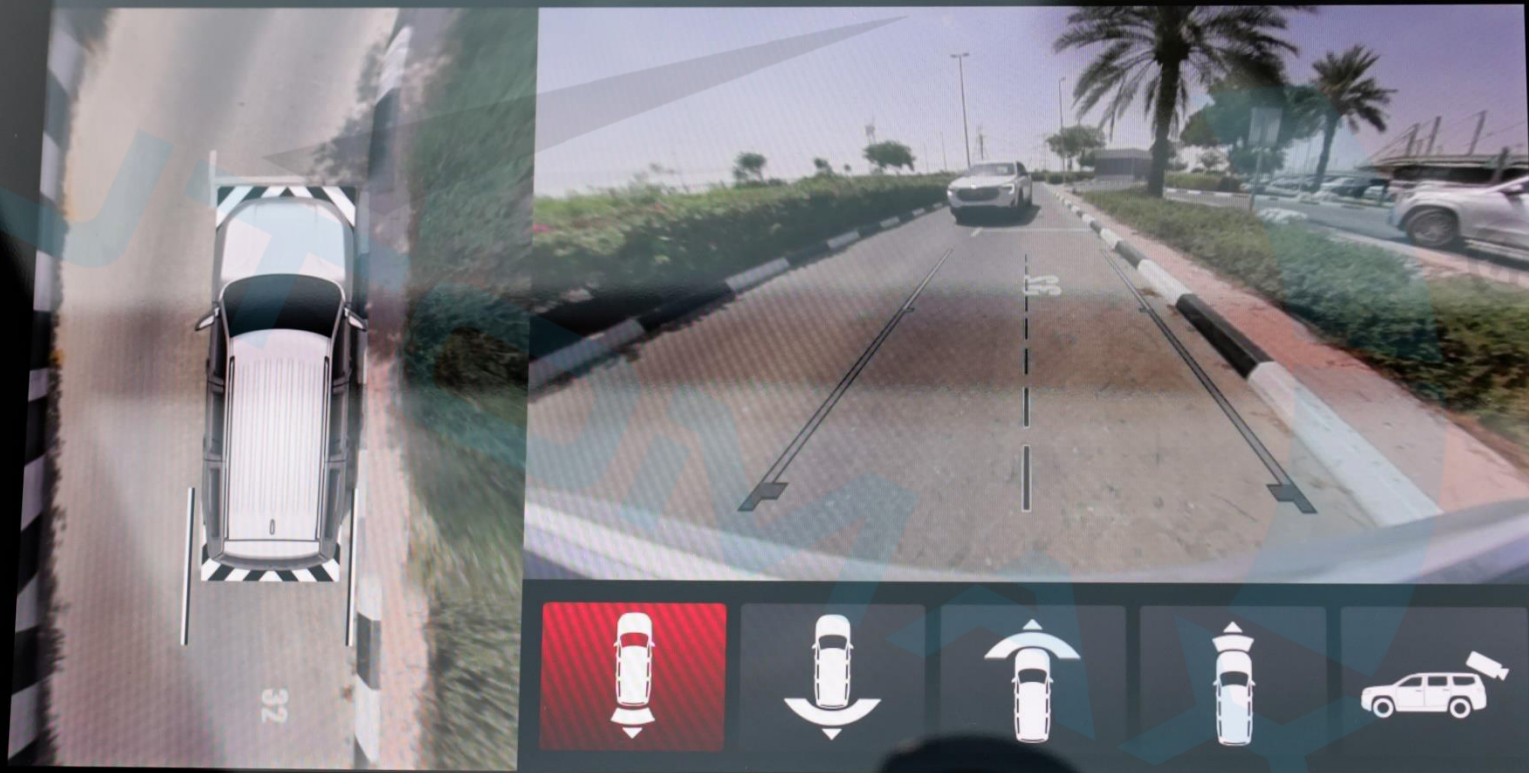

TUNE/
SCROLL



VOL



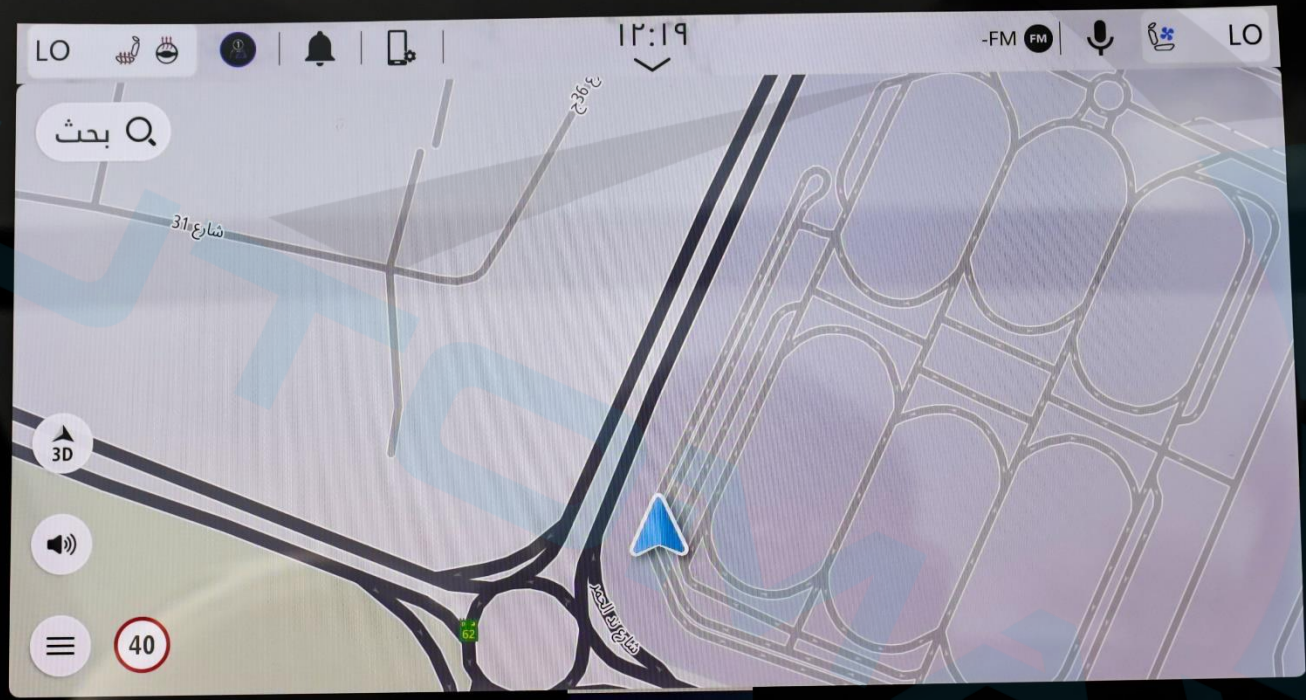

موتور
ZONE
موتور
ZONE

موتور
ZONE
موتور
ZONE

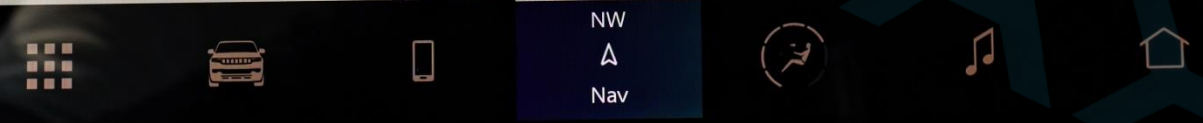

LO



12:14

DUBAI- FM

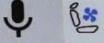

LO

الجميع

المفضلة



تهوية الراكب



تدفئة السائق



تدفئة الراكب



الراحة



مقود مدفأ

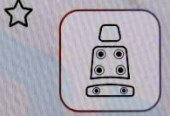

مقاعد التدليك



تهوية السائق

الوسائط

مريح

الملاحة

الهاتف

التطبيقات



NW



TUNE/SCROLL



MAX

REAR



OFF

AUTO

A/C





أراض وعرة

متحكمات

إعدادات

طي مسند
الرأس للصف
الثالث 

طي مسند
الرأس للصف
الثاني 

معتم المرأة 

Power Side
Step 

إيقاف
تشغيل
شاشة
الراكب 

شاشة
الراكب
مطفأة 

كاميرا الرؤية
الخلفية 

FamCam 

كاميرا الرؤية
المحيطية 



NW
A



TUNE/
SCROLL



LO



١٢:١٦

DUBAI- FM



LO

ديناميكيات
المركبة

ملحقات
المقاييس

انحدار و
التفاف

Selec-Terrain

نظام التعليق

زاوية التوجيه:
0°

حالة النقل:
غير مغلق

قفل المحور
الخلفي:
غير مغلق

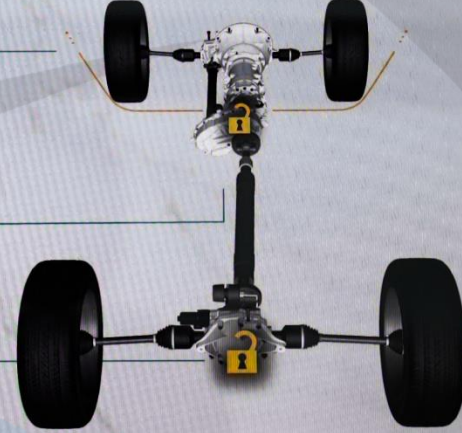

4WD
HIGH

55°21'60" E

25°10'07" N

ارتفاع 9 m

SPORT



المركبة



NW
A

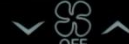

AUTO

A/C



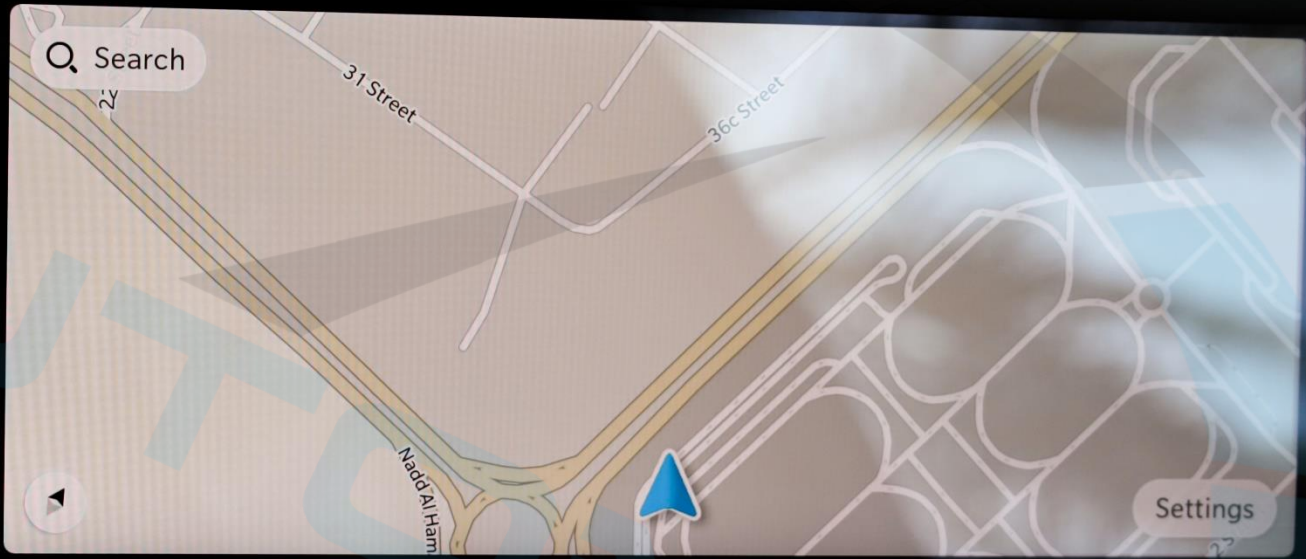

Home

Controls

G R A N D W A G O N E

Home



Controls

Audio



FM

AM

Bluetooth

More...

Video



USB 1

USB 2

More...

HDMI



HDMI
HIGH DEFINITION MULTIMEDIA INTERFACE

Connect HDMI Cable

GRAND WAGON



VOL ↑ ↓

TUNE SCROLL ↑ ↓

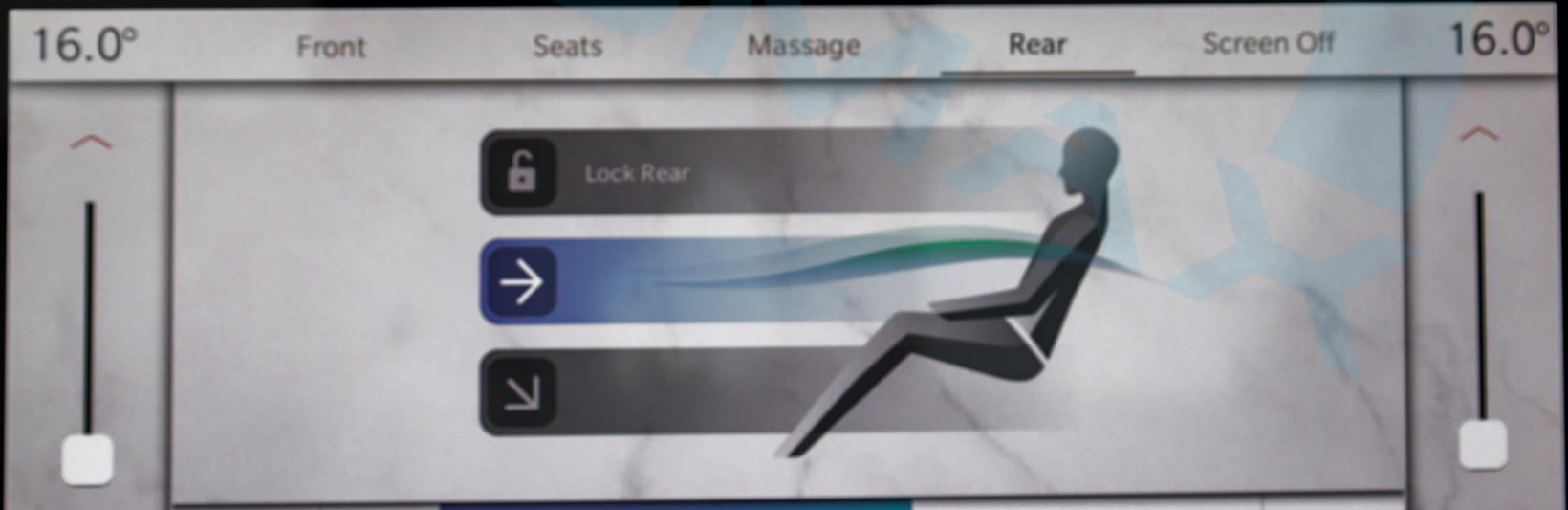

16.0°

Front

Seats

Massage

Rear

Screen Off

16.0°

Lock Rear





AUTO

A/C



Front Seats Massage Rear Screen Off

Waterfall	High	<p>Driver</p>	<p>Passenger</p>	High	Waterfall
Lower Back	Med			Med	Lower Back
Extend	Low			Low	Extend
Low Extend	Off			Off	Low Extend
Rock Climb					Rock Climb



MUTE



AUTO HOLD ON



OFF



OFF



ON



OFF



TOW/HAUL ON



OFF

ROCK SAND/AID



Front Seats Massage Rear Screen Off

	Lumbar Up/Down					Lumbar Up/Down	
	Lumbar In/Out					Lumbar In/Out	
	Back Bolster					Back Bolster	
	Thigh Bolster					Thigh Bolster	

Driver Passenger



ROCK SAND/MUD

Extend Low Off Driver Passenger Low Off Extend
Low Extend Rock Climb
Low Extend Rock Climb



MUTE OFF AUTO HOLD ON OFF OFF ON OFF TOW/HAIL ON

ROCK SAND/MUD SNOW AUTO SPORT

PRND

4WD LOW





MAX REAR AUTO A/C TUNE/SCROLL

Front Seats Massage Rear Screen Off

Waterfall	High	Driver	Passenger	High	Waterfall
Lower Back	Med			Med	Lower Back
Extend	Low			Low	Extend
Low Extend					Low Extend
Rock Climb	Off			Off	Rock Climb

4WD LOW

4WD LOW

4WD LOW





LO

Rear Comfort

Screen Off

16.0°

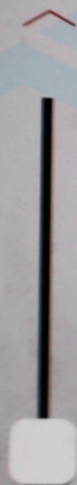

Rear Lock

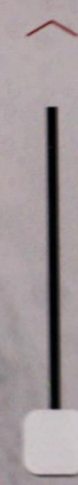
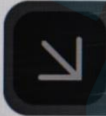
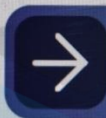

Sync

Off

1

2

3

4



5

6

7

Auto



ENGINEER

AIRBAG













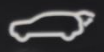

OPEN
AUTO
CLOSE

TILT
VENT
DOWN

OPEN
AUTO
CLOSE







2L

2R

3L

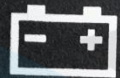

3R



12V DC

A horizontal row of controls on a dark leather dashboard. From left to right: a circular rotary knob for lighting, two small textured buttons for fog lights, and a rectangular button with four directional arrows.

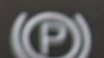
AUTO



PULL ON





۰۰۰۰۰

-

+

1

ADJUST

2

McIntosh





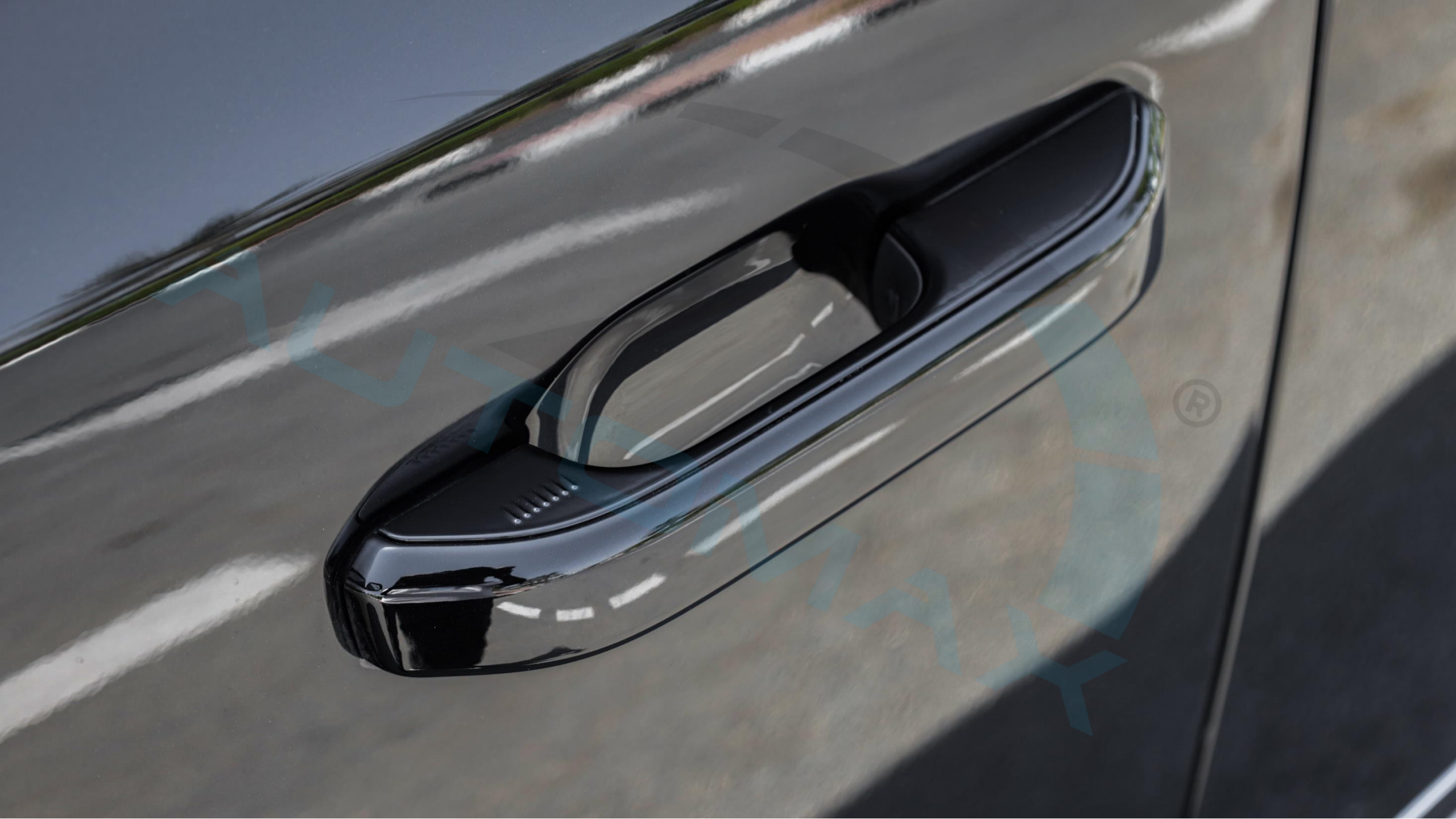





SEO 434630
P12221103 8841210000











GRAND WAGONEER





BRIDGESTONE

POTENZA HTL ALENZA

GRAND





لمشاهدة صورة السيارة بزاوية 360 درجة إضغط على الصورة أعلاه

Для просмотра автомобиля в формате 360°, пожалуйста, нажмите на фото выше.

To view the 360° degree please press on the picture above

2023 JEEP GRAND WAGONEER SERIES II 16 3.0L TT 4X4 GCC 0Km

Бренд: Jeep

Brand: Jeep

الماركة: جيب

Категория: GRAND WAGONEER

Category: GRAND WAGONEER

الفئة: GRAND WAGONEER

Модель: SERIES II LUXURY

Model: SERIES II LUXURY

الموديل: SERIES II LUXURY

Год: 2023

Year: 2023

السنة: 2023

Километров: 0 Km

Kilometers: 0 Km

كيلومترات: 0 كم

Двери: 4 Doors

Doors: 4 Doors

عدد الأبواب: 4 أبواب

Цвет: Черный

Color: Diamond Black

اللون: أسود

Цилиндр: 6

Cylinder: 6 Cylinders

عدد الأسطوانات: 6 أسطوانات

Лошадиные силы: 510 HP

Horsepower: 510 HP

عدد الأحصنة: 510 حصان

Трансмиссия: Автоматическая

Transmission: Automatic

نوع النقل: نقل أوتوماتيكي

Топливо: Бензин

Fuel: Gasoline

نوع الوقود: بنزين

4X4

4X4

المواصفات خليجية

4X4

2023 JEEP GRAND WAGONEER SERIES II 16 3.0L TT 4X4 GCC 0Km

LEATHER TRIMMED BUCKET SEATS
GLOBAL BLACK
MIDDLE EAST EQUIPMENT GROUP
OFF ROAD GROUP II
MONOTONE PAINT
AUX BATTERY
REMOVABLE ASH TRAY
8-SPD AUTO 8HP75 TRANS (BUY-US)
3.0L 16 HURRICANE HO TWIN TURBO ESS
AUTO DIM EXTERIOR DRIVER MIRROR
CIGAR LIGHTER
GPS NAVIGATION
GPS ANTENNA INPUT
ACTIVE NOISE CONTROL SYSTEM
EXT. MIRRORS W/SUPPLEMENTAL SIGNALS
EXTERIOR MIRRORS W/ARABIC LETTERING
EXTERIOR MIRRORS W/MEMORY
AUTO ADJUST IN REVERSE EXT MIRRORS
HEATED EXTERIOR MIRRORS

EXTERIOR MIRRORS APPROACH LAMPS
ROOF - BODY COLOR
QUADRA DRIVE II BADGE
U.S. EMISSIONS W/OBD 1
INTEGRATED TIRE COMPRESSOR KIT
DIAMOND BLACK CRYSTAL P/C
ALL RADIO EQUIPPED VEHICLES
12.0" TOUCHSCREEN DISPLAY
FRONT PASSENGER INTERACTIVE DISPLAY
DIGITAL AUDIO BROADCASTING
ALL R1 HIGH RADIOS
BRIDGESTONE BRAND TIRES
ALL ALUMINUM WHEELS
FUEL TANK SKID PLATE SHIELD
TRANSFER CASE SKID PLATE SHIELD
FRONT AXLE SKID PLATE
STOP-START DUAL BATTERY SYSTEM
ARABIC LANGUAGE
10 ADDITIONAL GALLONS OF GAS

2023 JEEP GRAND WAGONEER SERIES II 16 3.0L TT 4X4 GCS OKm

Quadra Drive II

INTEGRATED TIRE COMPRESSOR KIT

ADJUSTABLE ROOF RAIL CROSSBARS

7 местный

Зимний Пакет

Gear Limit

Вентиляция Сидений

Подогрев Сидений

Сиденья с функцией массажа

Рулевое Колесо с Подогревом

Регулируемые Сиденья с Памятью Позичий

Дистанционный Запуск Двигателя

Система Мониторинга Слепых Зон

Бесключевой Доступ

Регулировка Режимов Вождения

Подрулевые Лепестки

Пневмоподвеска

Дистанционное управление пневмоподвеской

Адаптивный Круиз-контроль

ДИСПЛЕЙ ДЛЯ ПАССАЖИРА

Камера Наблюдения Внутри Салона

Холодильник

Контурная Подсветка Салона

Система Экстренного Торможения

Контроль Полосы Движения

Проекция на лобовое стекло

MCINTOSH Премиальная Мультимедийная Система С 19-МИ ДИНАМИКАМИ

Камера 360 Градусов

Панорамная Крыша

Планшет

Беспроводная Зарядка

Система Помощи При Спуске с Горы

Датчик Давления в Шинах

Розетка

Задние Шторки

Система «Старт-Стоп»

Выдвижная Боковая Подножка

Автопарковка

R 20"

Apple Carplay

Android Auto

2023 JEEP GRAND WAGONEER SERIES II 16 3.0L TT 4X4 GCC 0Km

* الأداء:

ناقل حركة أوتوماتيكي ب 8 سرعات

عدد الأسطوانات: 6 أسطوانات

سعة المحرك: 3.0 توين توربو

العزم: 677 نيوتن.متر

عدد الأحصنة: 510 حصان

دفع رباعي 4X4

* المواصفات الإضافية:

Quadra Drive II

Gear Limit

INTEGRATED TIRE COMPRESSOR KIT

ADJUSTABLE ROOF RAIL CROSSBARS

7 مراتب

كاميرا بزاوية 360 درجة

شاشة بروجكتر أمامي

شاشة إضافية للمرافق

ثلاجة أمامية

تابلت للتحكم بالمقصورة الخلفية

عداد ديجيتال

مثبت السرعة التكييفي

نظام الهيدروليك لرفع و خفض المركبة مع خاصية التحكم عن بعد

نظام صوتي متقدم من MCINTOSH مع 19 سماعة

خاصية التبريد والتدفئة للمراتب

خاصية المساج للمراتب

فتحة سقف بانوراما مزدوجة

خاصية تثبيت المسار

كاميرا داخلية بزاوية 180 درجة

نظام الملاحة وتحديد المواقع

2023 JEEP GRAND WAGONEER SERIES II 16 3.0L TT 4X4 GCC 0Km

خاصية الكشف عن النقطة العمياء

أوتو بارك

دخول بصمة

خاصية تدفئة المقود

خاصية المساعدة في نزول المنحدرات

نظام البطارية المزدوجة للبدء والتوقف

خاصية التشغيل عن بعد

نظام مكابح متقدم مع الفرامل التلقائية

وضعية قيادة متعددة

مراتب كهربائية متعددة الوضعية مع خاصية الذاكرة

وحدة تكييف خلفية منفصلة

ابل كاربلاي لاسلكي

اندرويد أوتو لاسلكي

إنارة داخلية محيطيه

دبّة كهرباء مع حساس قدم

مخارج طاقة كهربائية متعددة

شاحن هاتف لاسلكي

ستائر خلفية

عتبات جانبية كهربائية

جنوط مقاس 20 بوصة

AUTOMAX®

The Boutique Of Muscle Cars, Truck Fanatics & German Automotive Experts.



تتکلم اللغة العربية

WE SPEAK ENGLISH

ON PARLE LE FRANCAIS

Nosotros hablamos español

мы говорим по-русски

biz o'zbek tilida

gaplashamiz

हम हिंदी बोलते हैं



automaxgroup.me



automax group



automax.dxb



Automax_LLC



+971 50 602 7200



automax.dxb



automax.dxb



automax.dxb



automax_dxb



automax group L.L.C

New Auto Market - Dubai - United Arab Emirates

 **Directions**