



AUTOMAX

GRAND DISCOVERY





GRAND WAGONEER

AUTOMAX
AUTOMAX 11000 11000



GRAND WAGONEER

GRAND WAGONEER

AUTOMAX
AUTOMAX IS A MEMBER OF



GRAND WAGONEER

AUTOMAX
AUTOMAX A.S. 2000 04 07 05



GRAND WAGONEER



GRAND WAGONEER







GRAND WAGONEER

AIRBAG

P

36°

0
km/h

92km

Top View

Front Seats Message

Lumbar Up/Down +

Lumbar Hi/Lo

Back Rest

Thigh Rest

Driver

START
ENGINE
STOP

GEAR
LIMIT

MUTE

OFF

AUTO
HOLD
ON

OFF



OK





SET+



CANC



RES



SET-

- GEAR
LIMIT +



0

km/h



AR
TOP
MAX

1. Driver info

P

37°C

NW



OFF RD

Driver Assist
Press Ok to Zoom In



1. Driver info



Hold OK for Digital

0

km/h
OK for MPH

Speedometer
80 km

P



OFF RD 2

ON OFF

OFF

OFF

NW

5. Off Road



AUTO

Automatic Full
Time 4WD
Adapts to
Road Conditions



P

37°C

OFF RD 2

Maximum
Ground Clearance



Terrain Status
80 km



4. Navigation

NW



Nadd Al Hamar Road

80 km

P



37°C

OFF RD



1000
1500
2000

Check entire surroundings



Top View

Rear View

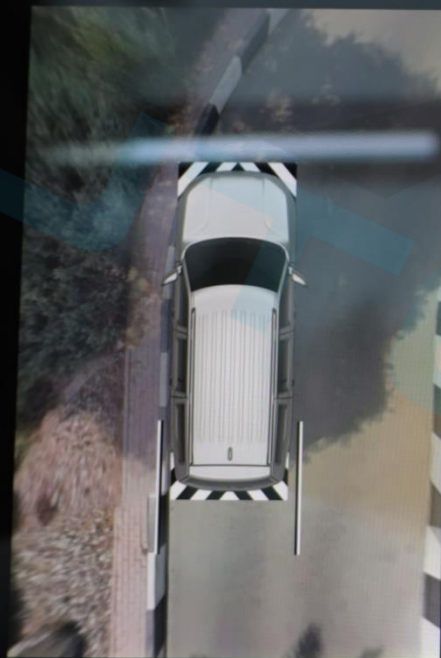

Select a seat to change zoom view



Volume control knob with VOL label and up/down arrows.

TUNE/SCROLL knob with up/down arrows.

Climate control panel with buttons for MAX, REAR, OFF, AUTO, A/C, and fan speed.

Map interface with search bar and street names (18a Street, 23 Street, 25c Street, 27c Street, 36c Street, 7 Street).

HITFM
HITFM ARN NETWORK - 044...
All presets [Play/Pause] [Next]

Phone
Select 'Add Device' to start the pairing process.
Add device Device Manager

Edit pages

VOL [Volume Knob]

TUNE [Tune Knob] SCROLL [Scroll Knob]

Pitch



1°

Roll

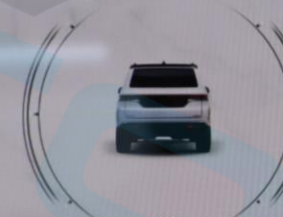

0°

Suspension

OFF RD 2



Edit pages

Home



NW



vol

TUNE SCROLL

LO [Icons] 1:34 FM HITFM [Icons] LO

Front Seats Massage Rear

Front defrost

Heat

Vent

Heat

Vent

Max A/C A/C Max Rear

Sync Off < 1 2 3 4 5 6 7 > Auto [Car Icon]

ZONE

VOL

ZONE

TUNE/SCROLL

Home Music Comfort NW A [Car Icon] [Grid Icon]

Wednesday, 2 October 2024 [Settings]

shortcuts
[Icons] icons to drag to status bar above



37°
OUT
Temperature

Profiles

Notifications



Fam Cam

Device Manager



Sync



LO [Icons] 1:34 [FM] HITFM [Icons] LO

Front **Seats** Massage Rear

- Lumbar Up/Down +		- Lumbar Up/Down +
- Lumbar In/Out +		- Lumbar In/Out +
- Back Bolster +		- Back Bolster +
- Thigh Bolster +		- Thigh Bolster +

Driver Psgr.



LO [Icons] 1:35 FM HITFM [Icons] LO

Front Seats **Massage** Rear

Waterfall

Lower back **High**

Extend Med

Low extend Low

Rock climb Off

Driver Psgr.

Waterfall

Lower back **High**

Extend Med

Low extend Low

Rock climb Off

VOL [Knob] [Home] [Music] **Comfort** [NW] [Phone] [Car] [Grid] [TUNE/SCROLL] [Knob]

[Icons] MAX REAR [Icons] OFF AUTO A/C [Icons]

22.0° Front Seats 22.0°

LO [Icons] 1:35 FM HITFM [Icons] LO

22° Front Seats Massage **Rear** 22°

Lock rear

→

↙

SYNC to driver Off < 1 2 3 4 5 6 7 > Auto



VOL [Knob] [Home] [Music] **Comfort** [NW] [Phone] [Car] [Grid] [TUNE SCROLL] [Knob]

[Air] [MAX] [REAR] [OFF] [AUTO] [A/C] [Icons]

LO | 1:36 HITFM | LO

Off road | **Controls** | Settings

Mirror Dimmer	2nd row headrest fold	3rd row headrest fold
Pass screen Screen off	Passenger screen power off	Power Side Step
Surround camera	FamCam	Rear View camera

MAX OFF

LO [Icons] 1:36 FM HITFM [Icons] LO

Vehicle Dynamics

Steering Angle: 0°

Transfer Case: Unlocked

Rear Axle Locker: Unlocked

Suspension 4WD HIGH 55°21'60" E 25°10'07" N Altitude -26 m AUTO

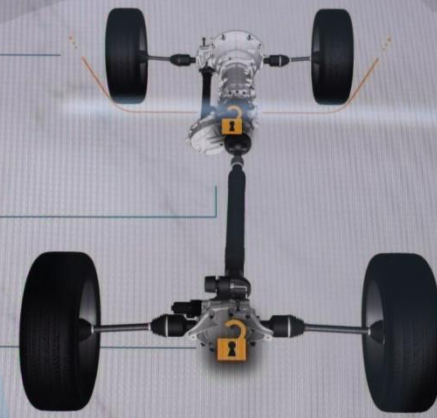

VOL

Home Music Phone NW A Vehicle [Grid]

TUNE/SCROLL

[MAX] [REAR] [Icons] [AUTO] [A/C]

Vehicle Dynamics

Accessory Gauges

Pitch & Roll

Selec-Terrain

Suspension

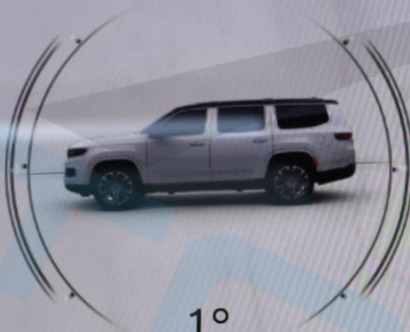

1°

Pitch

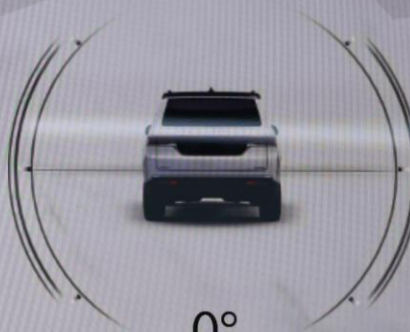

0°

Roll

4WD HIGH

55°21'60" E

25°10'07" N

Altitude -26 m

AUTO



NW



TUNE/SCROLL

Vehicle

LO 1:37 FM HITFM LO

Vehicle Dynamics

Accessory Gauges

Pitch & Roll

Selec-Terrain

Suspension



4WD HIGH 55°21'60" E 25°10'07" N Altitude -26 m AUTO



NW
A



Vehicle



TUNE/SCROLL

MAX REAR OFF AUTO A/C

- Automatic Emergency Braking >
- Display Active Lane Management >
- Entertainment screens ParkSense ⓘ Only warning Warning + braking assist
- My profile Front ParkSense Volume ⓘ Low Med High
- Safety & driving assistance Rear ParkSense Volume ⓘ Low Med High



LO [Icons] 13:38 FM HITFM [Icons] LO

Off road Controls Settings

Blind Spot Alert Off Lights Lights + chime

Electric power steering default Normal Sport Comfort

Power Side Step Auto Store

Hill Start Assist

Tire Fill Assist

Display

Entertainment screens

My profile

Safety & driving assistance



NW
A



Vehicle



TUNE/SCROLL

VOL



LO [Icons] 13:38 FM HITFM [Icons] LO

Favourites All

Media

Comfort

Nav

Phone

AM	AM radio	Audio settings	Auxiliary cable	Bluetooth
DAB	DAB	Device Manager	FM radio	Media

ZONE

[Icons]

ZONE

[Icons]

VOL

[Knob]

TUNE/SCROLL

[Knob]

[Home] [Music] [Phone] [NW] [Car] [Apps]

LO [Icons] 13:38 FM HITFM [Icons] LO

Favourites All

Media Comfort Nav Phone

DAB DAB Device Manager FM FM radio Media

USB 1 USB 2

VOL

TUNE SCROLL

Home Music Sports NW Car Apps

Favourites

All

Media

Comfort

Nav

Phone



Comfort



Driver Heat



Driver Vent



Heated wheel



Massage seats



Psgr heat



Psgr vent



NW
A



Apps



AUTO

A/C



LO [Icons] 13:38 FM HITFM [Icons] LO

Favourites All

Media

Comfort

Nav

Phone

Android Auto

Device Manager

Phone

Apps

VOL

TUNE/SCROLL

START ENGINE STOP

[Climate and vehicle control icons]

LO [Icons] 13:39 FM HITFM [Icons] LO

Favourites All

- Phone
- Vehicle**
- System
- Other

Ambient Colour	Audio settings	Controls	FamCam
Mirror dimmer	Off Road Pages	Rear view camera	Select. tyre fill alert



Home Music Navigation Phone Vehicle Apps

MAX REAR [Icons] AUTO A/C [Icons]

Favourites All

Phone

Vehicle

System

Other

☆
Settings

☆
Surround camera

☆
Vehicle

☆
2nd row headrest...

☆
3rd row headrest...

Favourites All

Phone

Vehicle

System

Other



Driver profiles



Software updates



Stored Notificati...



NW
A



Apps



LO [Icons] 13:39 FM HITFM [Icons] LO

Favourites All

- Phone
- Vehicle
- System
- Other



McIntosh



Relax



Tutorials

Home Music Navigation Phone Vehicle Apps

ZONE [Icons]
VOL [Knob]

ZONE [Icons]
TUNE/SCROLL [Knob]

[Icons] MAX REAR [Icons] OFF AUTO A/C [Icons]

LO | | | 13:41 HITFM | LO

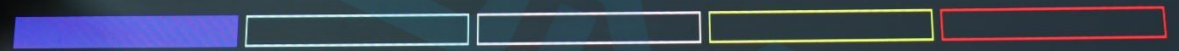
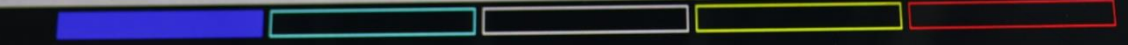

Показать весь доступный диапазон



Вид сверху

Вид сзади



VOL

TUNE SCROLL

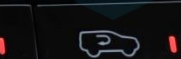

22.0°

Front

Seats

Massage

Rear

Screen Off

22.0°

Выбрать сиденье, чтобы изменить масштабированный вид



Управление климатом

↑&G

ZONE
*
⏻

↕
TUNE/
SCROLL

MAX REAR OFF AUTO A/C

Низ. | | 13:48 HITFM | Низ.

Поиск Street

22 Street 25c Street 23 Street 13b Street
31 Street 27c Street 36c Street Nadd Al Hamar Road

3D

40

VOL

C3
▲
Nav

TUNE SCROL

START ENGINE STOP

Наклон



1°

Крен

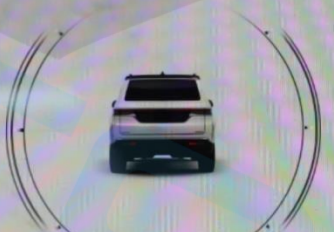

0°

Подвески

OFF RD 2



Редактировать страницы

Главная



C3
A



VOL

TUNE
SCROLL

Передн. Сиденья **Массаж** Задний

Расслабл.

Низ спины

Растягив.

Низ растягив.

Энергичный

Гром.

Сред.

Низ.

Off



Водит.



Пассаж.

Гром.

Сред.

Низ.

Off

Расслабл.

Низ спины

Растягив.

Низ растягив.

Энергичный



Comfort

C3



Низ. 13:47 FM HITFM Низ.

Передн. Сиденья Массаж Задний

Пер. обдув

Об. Вен

Макс. А/С A/C Максим. Задний

Синхр. Off 1 2 3 4 5 6 7 Авт.

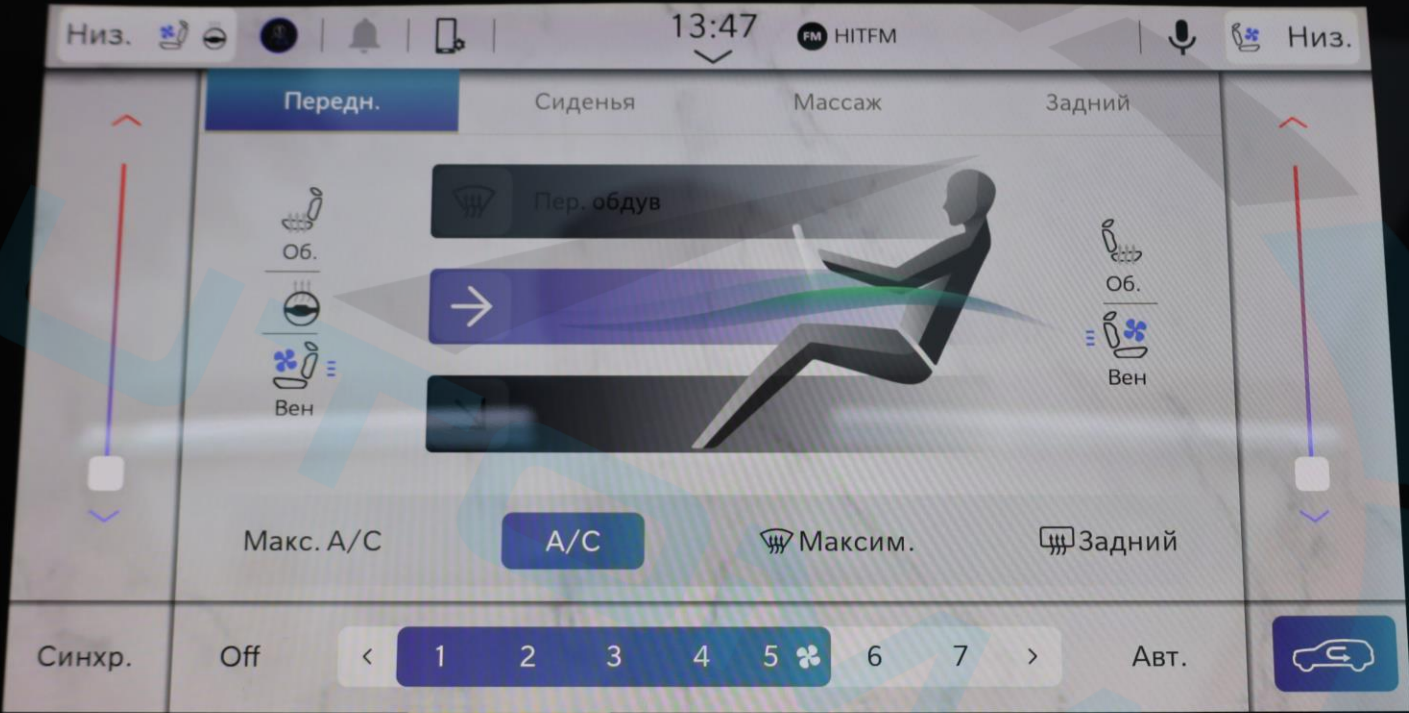

**Динамика
автомобиля**

Угол поворота
рулевого колеса:
0°

**Вспомог.
приборы**

Раздаточная
коробка:
Разблокирована

**Попер.
перемещения**

Selec-Terrain

Блокиратор
заднего моста:
Разблокирована

Подвески

4WD HIGH 55°21'60" В 25°10'07" С Высота -26 м AUTO

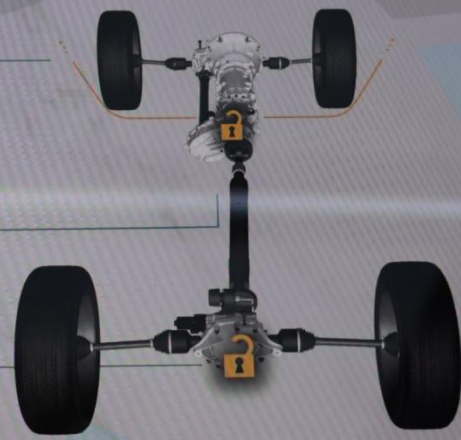

VOL
↑ ↓



C3
A



АВТОМ.



TUNE
SCROLL



تحقق من البيئة المحيطة بأكملها



الرؤية العلوية

الرؤية الخلفية

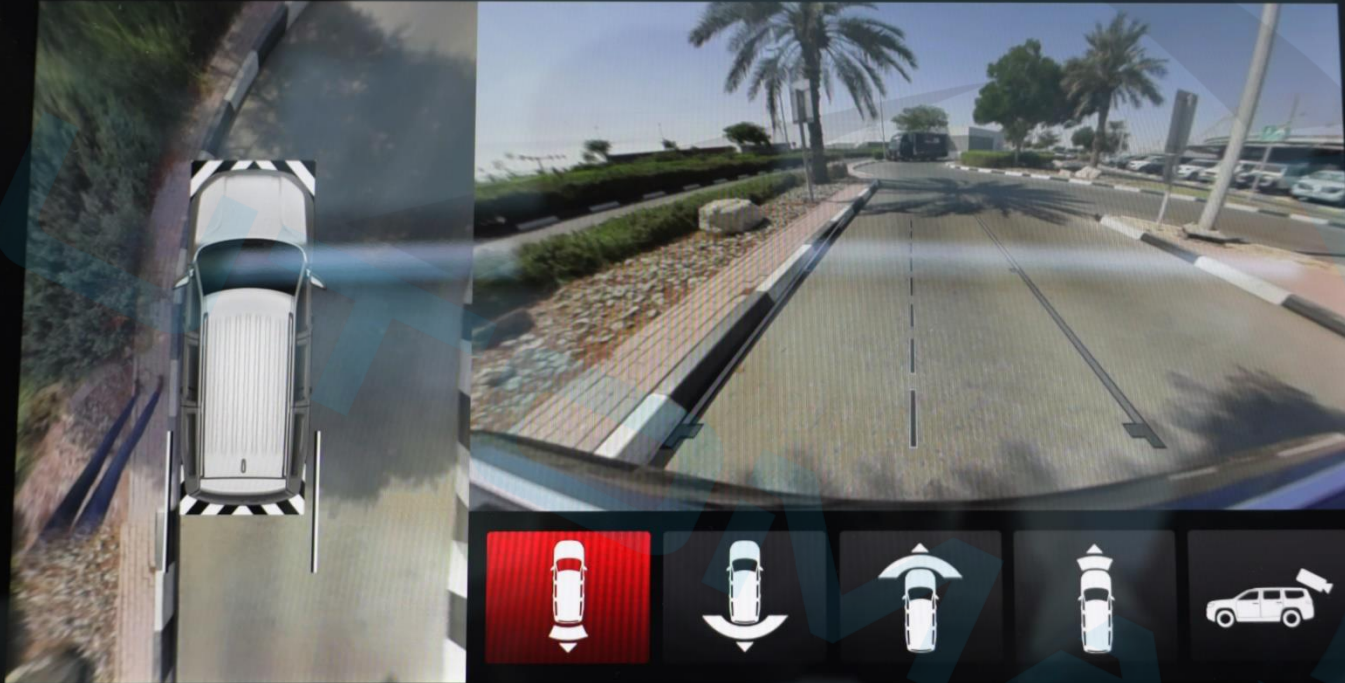

اختر مقعد لتغيير تكبير العرض



TUNE/SCROLL

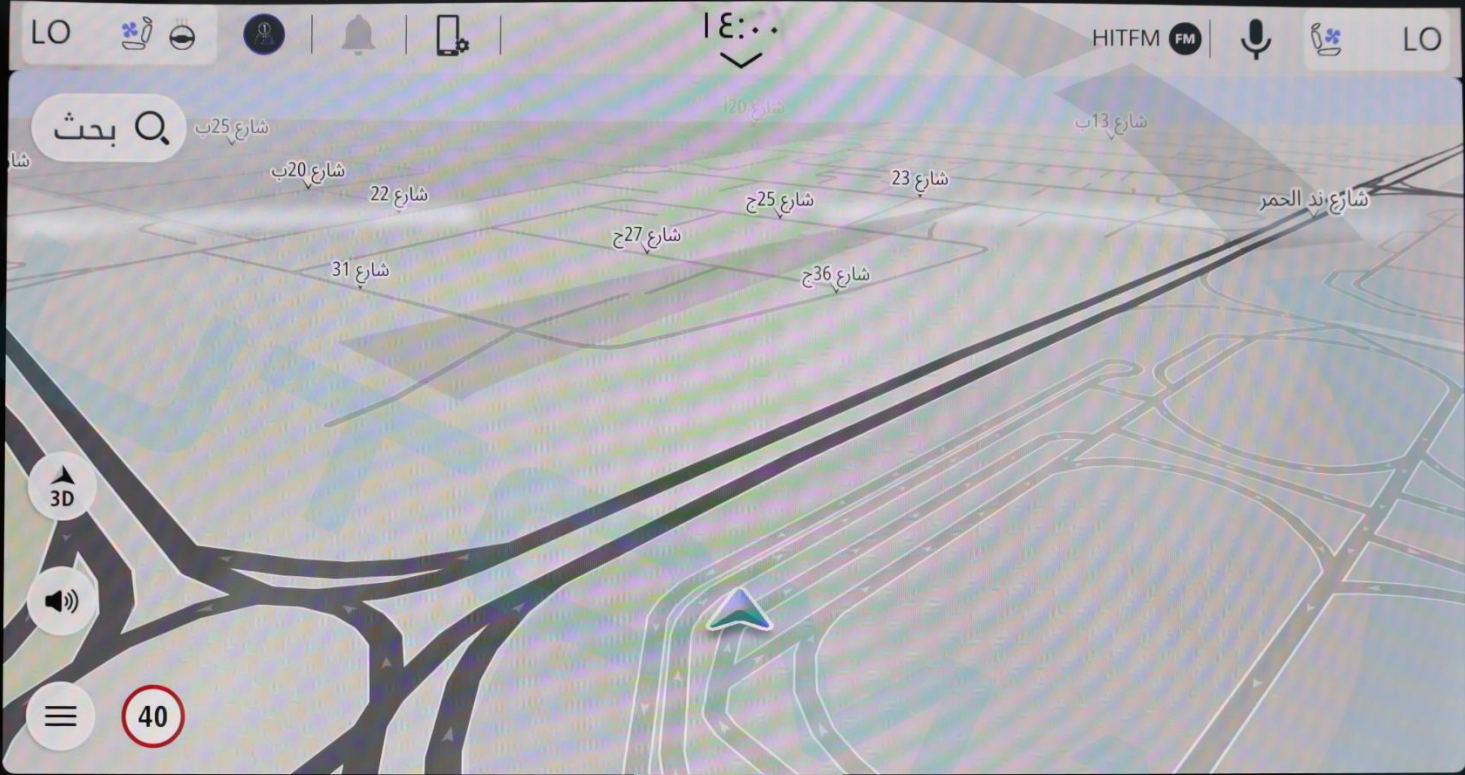

موسيقى
منازل
ZONE
منازل
موسيقى

موسيقى
منازل
ZONE
منازل
موسيقى

VOL

TUNE/SCROLL

START ENGINE STOP

MAX REAR

نظام التعليق

OFF RD 2



انحدار

1°

التفاف

0°



تحرير الصفحات

LO [Icons] 13:09 HITFM FM [Icons] LO

الأمامي المقاعد تدليك خلفي

إزالة الصقيع الأمامي

تسخين تبريد

تسخين تبريد

أقصى تكييف الهواء حد أقصى خلفي

مزامنة Off 1 2 3 4 5 6 7 ألي

مقاعد
ZONE

مقاعد
ZONE

VOL

TUNE/SCROLL



NW



Comfort



LO 14:00 HITFM FM LO

الاسترخاء المقاعد تدليك خلفي الاسترخاء

الاسترخاء المقاعد تدليك خلفي الاسترخاء

أسفل الظهر عالي أسفل الظهر

تمديد متوسط

تمديد منخفض

تمديد أسفل الظهر Off

شديد

السائق الراكب

عالي متوسط منخفض Off

أسفل الظهر تمديد أسفل الظهر شديد



NW
A



Comfort



TUNE/SCROLL

LO | ١٤:٠٠ | HITFM FM LO

الأمامي المقاعد تدليك **خلفي**

٥٢٢ ٥٢٢

قفل الخلفي

المزامنة مع السائق Off < 1 2 3 4 5 6 7 > آلي

ZONE

ZONE

VOL

TUNE/SCROLL

Comfort

LO



١٤:٠٦

HITFM FM



LO

ديناميكيات
المركبة

زاوية التوجيه:
0°

ملحقات
المقاييس

حالة النقل:
غير مغلق

انحدار و
التفاف

Selec-Terrain

قفل المحور
الخلفي:
غير مغلق

نظام التعليق

4WD
HIGH

55°21'60" E

25°10'07" N

ارتفاع -26 m

AUTO

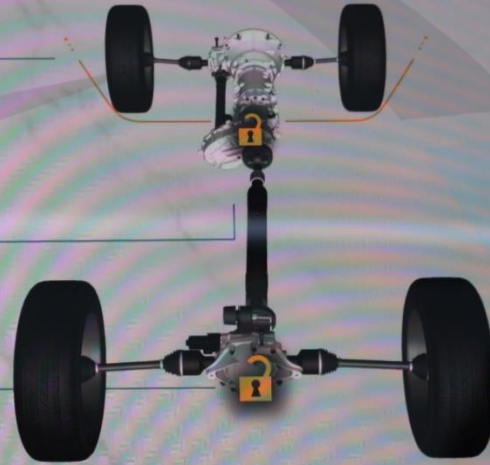

المركبة



NW
A



VOL

TUNE/
SCROLL



Тел.



АВТОМ.

Система



Navigation arrows, MAX, REAR, OFF, AUTO, A/C, Car icon, Navigation arrows

LO Front Seats Massage Rear Screen Off LO

Front Defrost

→

↘

Sync Off 1 2 3 4 5 6 7 Max A/C

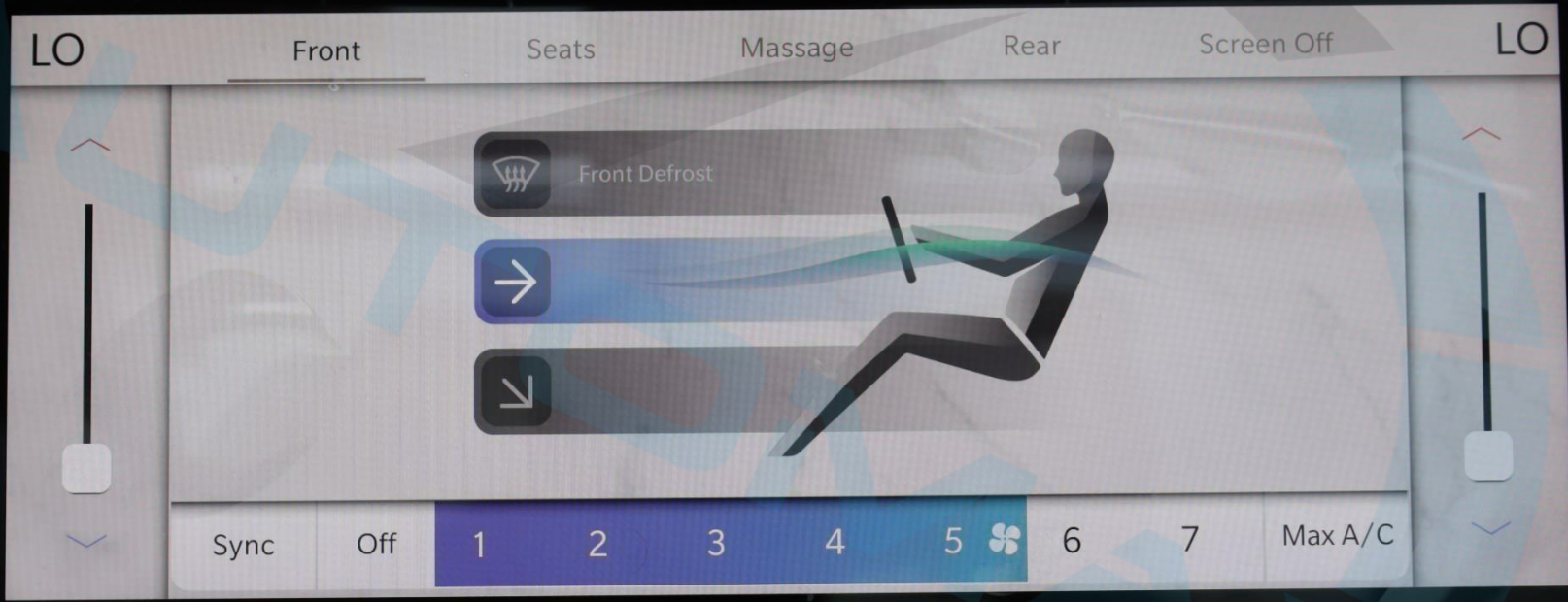

Navigation arrows, MUTE, AUTO HOLD ON, OFF, OFF, ON, OFF, TOW/HAUL ON, Navigation arrows



MAX

REAR



AUTO

A/C



Front

Seats

Massage

Rear

Screen Off

Lumbar Up/Down

— +

Lumbar In/Out

— +

Back Bolster

— +

Thigh Bolster

— +



Driver



Passenger

Lumbar Up/Down

— +

Lumbar In/Out

— +

Back Bolster

— +

Thigh Bolster

— +



MUTE



AUTO HOLD ON



PC ON

OFF

TOW HAUL ON





AUTO

A/C



Front Seats Massage Rear Screen Off

Waterfall	High	<p>Driver</p>	<p>Passenger</p>	High	Waterfall
Lower Back	Med			Med	Lower Back
Extend	Low			Low	Extend
Low Extend	Off			Off	Low Extend
Rock Climb					Rock Climb



MUTE



AUTO HOLD ON



ON



TOW/HAUL ON



P

Home



Controls

Vehicle cameras

Fam Cam

Rear View

Check entire surrounding

Top View

Rear View

Surround View

AND WAGON

Home

Controls

Audio 

 Bluetooth

 FM

 AM

More...

Video 

 USB 1

 USB 2

More...

HDMI 

HDMI
HIGH DEFINITION MULTIMEDIA INTERFACE

Connect HDMI cable

Home



Controls

Navigation



Search



Favourites

Recent

Devices



0 devices connected



Pair new device



Manage Bluetooth headphones

Cameras

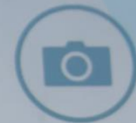

View vehicle
Camera apps



W A G O

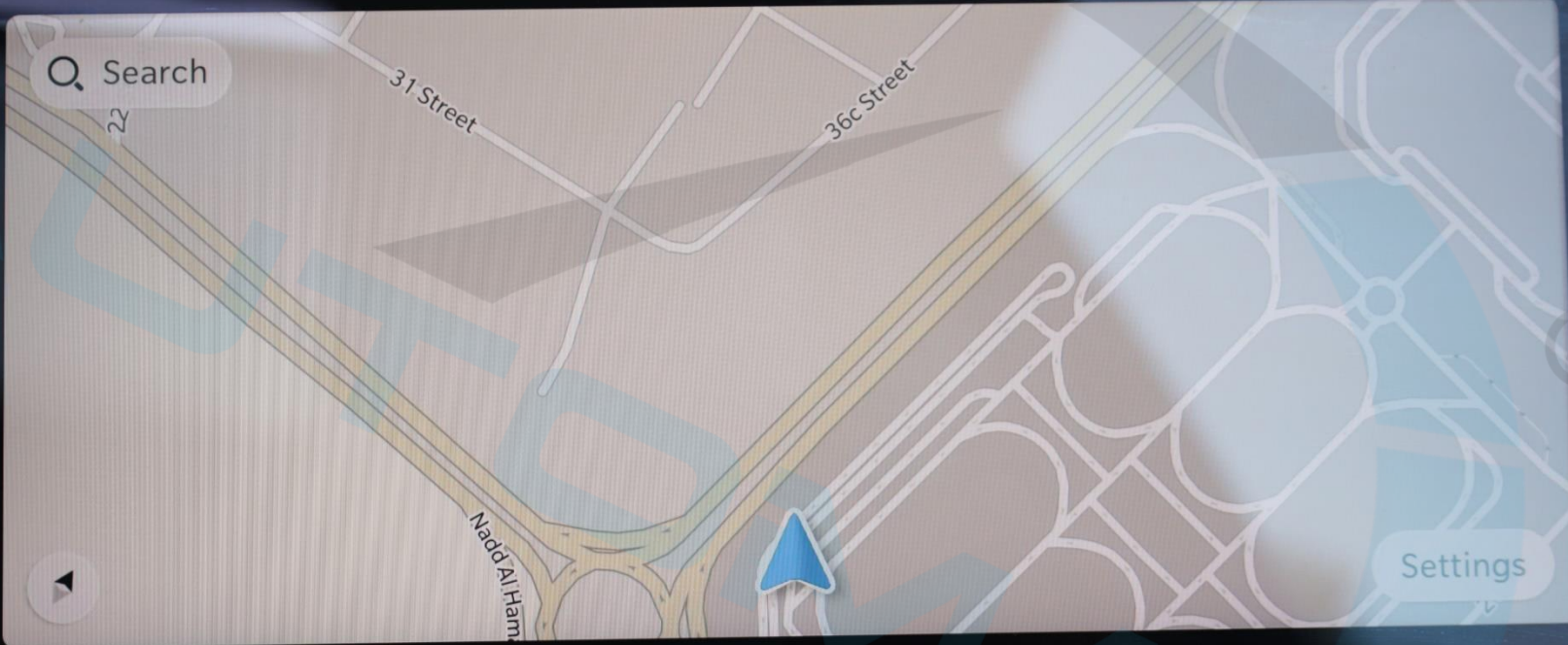

Home

Controls

Search

Settings

31 Street

36c Street

Nadd Al Ham

C R A N D W A G O N



Sync

Off

1

2

3

4

5



6

7

Max A/C



MUTE



AUTO
HOLD
ON

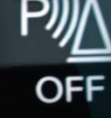

TOW/
HAUL
ON



P R N D

ROCK
SAND/MUD
SNOW
AUTO
SPORT



Sync Off 1 2 3 4 5 6 7 Max A/C

MAP AUTO OFF AUTO HOLD ON L4 OFF TRIP OFF PWR ON PWR OFF TOW HACE ON

P R N D

ROCK
SAND/MUD
SNOW
AUTO
SPORT

←
|
|
|
|
→

4WD
LOW

4x4

4N



22.0°

Rear Comfort

Screen Off

22.0°

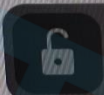
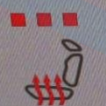

Rear Lock

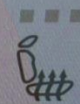

Sync

Off

1

2

3

4



5

6

7

Auto

230 V AC
150 W

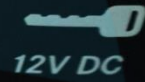

12V DC



AIRBAG

GRAND WAGONER













OFF



ON



OPEN



CLOSE

TILT



DOWN

OPEN



CLOSE



START
ENGINE
STOP

RUN

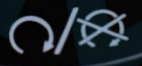





12V DC









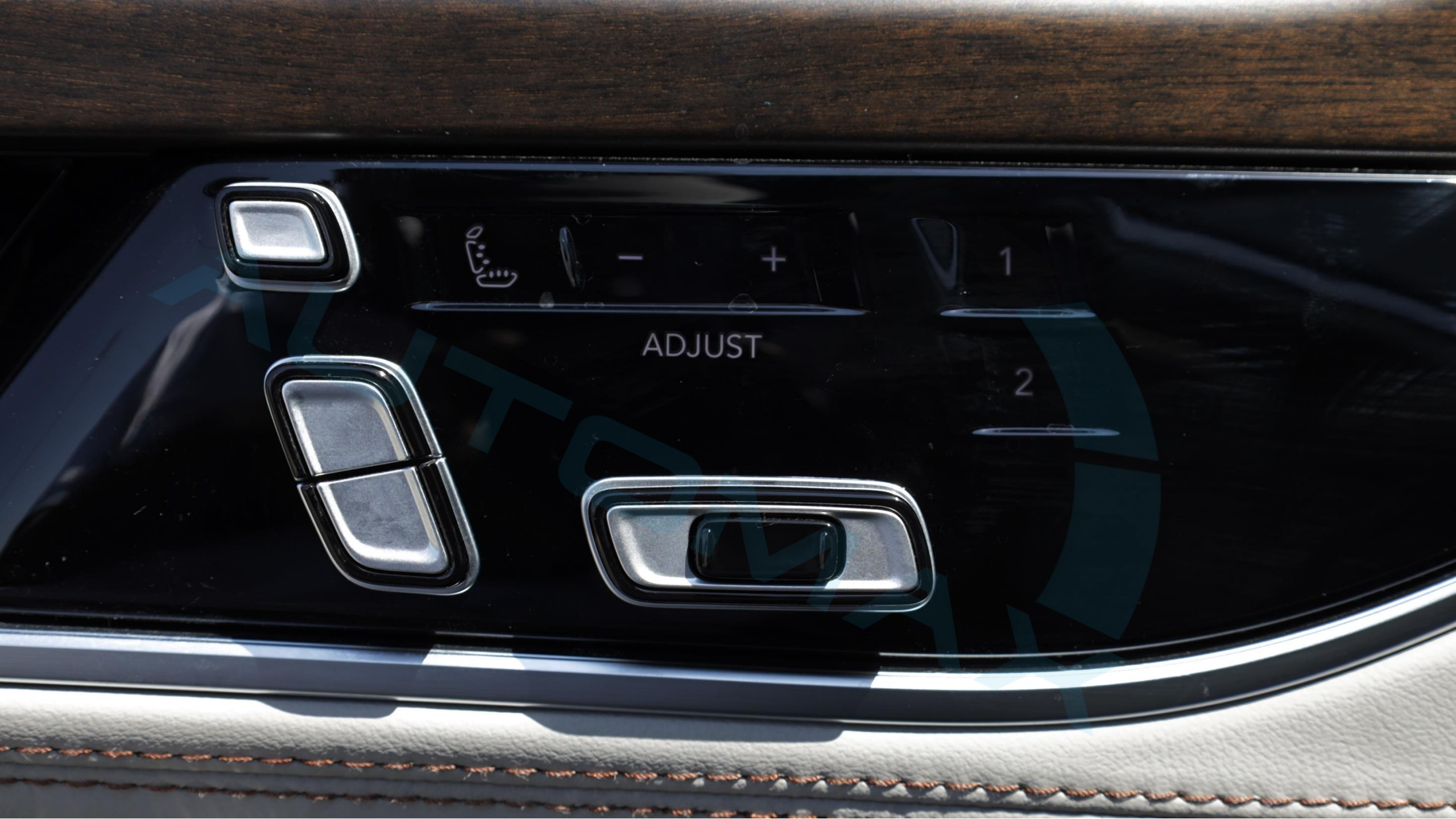

ADJUST

1

2













P:810 SEQ:447200
PS530342 68400498AA



GRAND WAGONEER







GRAND WAGONEER



G R





لمشاهدة صورة السيارة بزاوية 360 درجة إضغط على الصورة أعلاه

Для просмотра автомобиля в формате 360°, пожалуйста, нажмите на фото выше.

To view the 360° degree please press on the picture above

2023 JEEP GRAND WAGONEER SERIES II 16 3.0L TT 4X4 GCC 0Km

Бренд: Jeep

Brand: Jeep

الماركة: جيب

Категория: GRAND WAGONEER

Category: GRAND WAGONEER

الفئة: GRAND WAGONEER

Модель: SERIES II LUXURY

Model: SERIES II LUXURY

الموديل: SERIES II LUXURY

Год: 2023

Year: 2023

السنة: 2023

Километров: 0 Km

Kilometers: 0 Km

كيلومترات: 0 كم

Двери: 4 Doors

Doors: 4 Doors

عدد الأبواب: 4 أبواب

Цвет: Синий

Color: Midnight Sky/ Sea Salt

اللون: ليلي داكن

Цилиндр: 6

Cylinder: 6 Cylinders

عدد الأسطوانات: 6 أسطوانات

Лошадиные силы: 510 HP

Horsepower: 510 HP

عدد الأحصنة: 510 حصان

Трансмиссия: Автоматическая

Transmission: Automatic

نوع النقل: نقل أوتوماتيكي

Топливо: Бензин

Fuel: Gasoline

نوع الوقود: بنزين

4X4

4X4

المواصفات خليجية

4X4

2023 JEEP GRAND WAGONEER SERIES II 16 3.0L TT 4X4 GCC 0Km

LEATHER TRIMMED BUCKET SEATS
SEA SALT/BLACK
MIDDLE EAST EQUIPMENT GROUP
OFF ROAD GROUP II
FLEXIBLE SEATING GROUP
AUX BATTERY
40/20/40 2ND ROW BENCH PWR TIP/SLIDE
REMOVABLE ASH TRAY
8 PASSENGER SEATING
8-SPD AUTO 8HP75 TRANS (BUY-US)
3.0L 16 HURRICANE HO TWIN TURBO ESS
AUTO DIM EXTERIOR DRIVER MIRROR
CIGAR LIGHTER
GPS NAVIGATION
GPS ANTENNA INPUT
ACTIVE NOISE CONTROL SYSTEM
EXT. MIRRORS W/SUPPLEMENTAL SIGNALS
EXTERIOR MIRRORS W/ARABIC LETTERING
EXTERIOR MIRRORS W/MEMORY
AUTO ADJUST IN REVERSE EXT MIRRORS

HEATED EXTERIOR MIRRORS
EXTERIOR MIRRORS APPROACH LAMPS
BLACK ROOF
QUADRA DRIVE II BADGE
U.S. EMISSIONS W/OBD I
INTEGRATED TIRE COMPRESSOR KIT
MIDNIGHT SKY
ALL RADIO EQUIPPED VEHICLES
12.0" TOUCHSCREEN DISPLAY
FRONT PASSENGER INTERACTIVE DISPLAY
2ND ROW DUAL CHG-ONLY USB PORTS
DIGITAL AUDIO BROADCASTING
ALL R1 HIGH RADIOS
BRIDGESTONE BRAND TIRES
ALL ALUMINUM WHEELS
FUEL TANK SKID PLATE SHIELD
TRANSFER CASE SKID PLATE SHIELD
FRONT AXLE SKID PLATE
STOP-START DUAL BATTERY SYSTEM
10 ADDITIONAL GALLONS OF GAS

2023 JEEP GRAND WAGONEER SERIES II 16 3.0L TT 4X4 GCS OKm

Quadra Drive II

INTEGRATED TIRE COMPRESSOR KIT

ADJUSTABLE ROOF RAIL CROSSBARS

8 местный

Зимний Пакет

Gear Limit

Вентиляция Сидений

Подогрев Сидений

Сиденья с функцией массажа

Рулевое Колесо с Подогревом

Регулируемые Сиденья с Памятью Позций

Дистанционный Запуск Двигателя

Система Мониторинга Слепых Зон

Бесключевой Доступ

Регулировка Режимов Вождения

Подрулевые Лепестки

Пневмоподвеска

Дистанционное управление пневмоподвеской

Адаптивный Круиз-контроль

ДИСПЛЕЙ ДЛЯ ПАССАЖИРА

Камера Наблюдения Внутри Салона

Холодильник

Контурная Подсветка Салона

Система Экстренного Торможения

Контроль Полосы Движения

Проекция на лобовое стекло

MCINTOSH Премиальная Мультимедийная Система С 19-МИ ДИНАМИКАМИ

Камера 360 Градусов

Панорамная Крыша

Беспроводная Зарядка

Система Помощи При Спуске с Горы

Датчик Давления в Шинах

Розетка

Задние Шторки

Система «Старт-Стоп»

Выдвижная Боковая Подножка

Автопарковка

R 20"

Apple Carplay + Android Auto

2023 JEEP GRAND WAGONEER SERIES II 16 3.0L TT 4X4 GCC 0Km

* الأداء:

ناقل حركة أوتوماتيكي ب 8 سرعات

عدد الأسطوانات: 6 أسطوانات

سعة المحرك: 3.0 توين توربو

العزم: 677 نيوتن.متر

عدد الأحصنة: 510 حصان

دفع رباعي 4X4

* المواصفات الإضافية:

Quadra Drive II

Gear Limit

INTEGRATED TIRE COMPRESSOR KIT

ADJUSTABLE ROOF RAIL CROSSBARS

8 مراتب

كاميرا بزاوية 360 درجة

شاشة بروجكتر أمامي

شاشة إضافية للمرافق

ثلاجة أمامية

عداد ديجيتال

مثبت السرعة التكميلي

نظام الهيدروليك لرفع و خفض المركبة مع خاصية التحكم عن بعد

نظام صوتي متقدم من MCINTOSH مع 19 سماعة

خاصية التبريد والتدفئة للمراتب

خاصية المساج للمراتب

فتحة سقف بانوراما مزدوجة

خاصية تثبيت المسار

كاميرا داخلية بزاوية 180 درجة

نظام الملاحة وتحديد المواقع

2023 JEEP GRAND WAGONEER SERIES II 16 3.0L TT 4X4 GCC 0Km

خاصية الكشف عن النقطة العمياء

أوتو بارك

التشغيل عن بعد

دخول بصمة

خاصية تدفئة المقود

خاصية المساعدة في نزول المنحدرات

نظام البطارية المزدوجة للبدء والتوقف

نظام مكابح متقدم مع الفرامل التلقائية

وضعية قيادة متعددة

مراتب كهربائية متعددة الوضعية مع خاصية الذاكرة

وحدة تكييف خلفية منفصلة

ابل كاربلاي لاسلكي

اندرويد أوتو لاسلكي

إنارة داخلية محيطيه

دبّة كهرباء مع حساس قدم

مخارج طاقة كهربائية متعددة

شاحن هاتف لاسلكي

ستائر خلفية

عتبات جانبية كهربائية

جنوط مقاس 20 بوصة

AUTOMAX®

The Boutique Of Muscle Cars, Truck Fanatics & German Automotive Experts.



تتکلم اللغة العربية

WE SPEAK ENGLISH

ON PARLE LE FRANCAIS

Nosotros hablamos español

мы говорим по-русски

biz o'zbek tilida

gaplashamiz

हम हिंदी बोलते हैं



automaxgroup.me



automax group



automax.dxb



Automax_LLC



+971 50 602 7200



automax.dxb



automax.dxb



automax.dxb



automax_dxb



automax group L.L.C

New Auto Market - Dubai - United Arab Emirates

 **Directions**