



AUTOMAX

GRAND DISCOVERY





GRAND WAGONEER

AUTOMAX  
AUTOMAX 11000 91000



GRAND WAGONEER

GRAND WAGONEER

AUTOMAX  
AUTOMAX IS A MEMBER OF



GRAND WAGONEER

AUTOMAX  
AUTOMAX H. 2. 2000 04 87 05



GRAND WAGONEER



GRAND WAGONEER



GRAND WAGONEER







GRAND WAGONEER

AIRBAG

P

36°

0  
km/h

92km

Top View

Front Seats Message

Lumbar Up/Down +

Lumbar Hi/Lo

Back Rest

Thigh Rest

Driver

START  
ENGINE  
STOP

GEAR  
LIMIT

MUTE

OFF

AUTO  
HOLD  
ON

OFF



OK





SET+



CANC



RES



SET-

- GEAR  
LIMIT +



0

km/h

AUTOTONMAXX

1. Driver info

P

37°C

NW



OFF RD

Driver Assist  
Press Ok to Zoom In



1. Driver info



Hold OK for Digital

0

km/h  
OK for MPH

Speedometer  
80 km

P



OFF RD 2

ON OFF

OFF

OFF

NW

5. Off Road

AUTO

Automatic Full  
Time 4WD  
Adapts to  
Road Conditions



P  
OFF RD 2  
Maximum  
Ground Clearance

37°C



Terrain Status  
80 km



OFF RD 2



ON OFF  
PULL  
- WIPER  
WASH



# 4. Navigation

NW



Nadd Al Hamar Road

80 km

P



37°C

OFF RD



24d Street

27c Street

25c Street

36c Street

23 Street

31 Street

6000  
6000  
6000

Check entire surroundings



Top View

Rear View

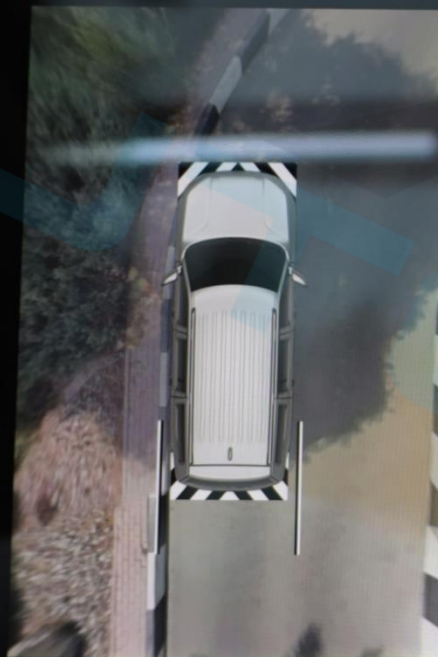

Select a seat to change zoom view

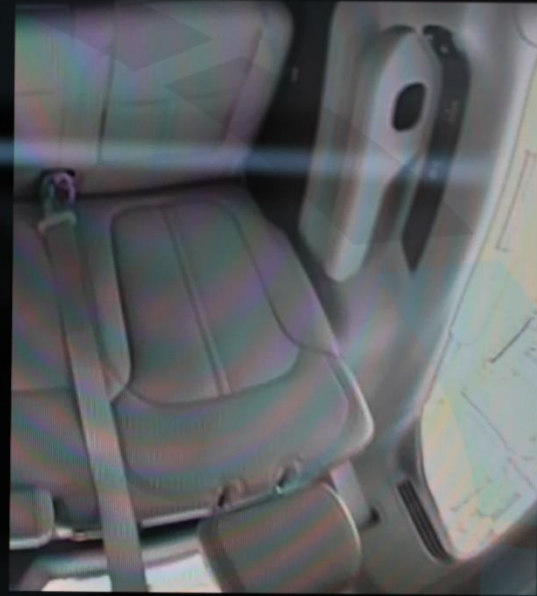

Volume control knob with VOL label and up/down arrows.

TUNE/SCROLL knob with up/down arrows.

Climate control panel with buttons for MAX, REAR, OFF, AUTO, A/C, and fan speed.

Map interface with search bar and street names:

- Search
- 18a Street
- 7 Street
- 23 Street
- 25c Street
- 27c Street
- 36c Street

Radio player interface:

- HITFM
- HITFM ARN NETWORK - 044...
- All presets
- Play/Pause buttons

Phone pairing interface:

- Phone
- Select 'Add Device' to start the pairing process.
- Add device
- Device Manager

Edit pages



**Pitch** **Roll**

1° 0°

**Suspension**

OFF RD 2

Edit pages

Home



NW



Volume knob and touch-sensitive buttons for climate and other functions.

Touch-sensitive buttons for climate, suspension, and other functions, including a 'TUNE SCROLL' knob.

LO [Icons] 1:34 FM HITFM [Icons] LO

Front Seats Massage Rear

Front defrost

Heat

Vent

Heat

Vent

Max A/C A/C Max Rear

Sync Off < 1 2 3 4 5 6 7 > Auto [Car Icon]



[Home] [Music] [Comfort] [NW A] [Phone] [Car] [Grid] [TUNE/SCROLL]



Wednesday, 2 October 2024 [Settings]

shortcuts  
Icons to drag to status bar above

- [Icon]
- [Icon]
- [Icon]
- Sync

37°  
OUT  
Temperature

[Icon]  
Profiles

[Icon]  
Notifications

[Icon]  
Fam Cam

[Icon]  
Device Manager

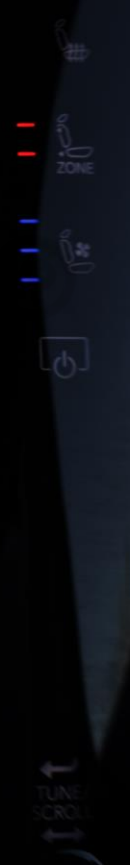

LO [Icons] 1:34 [FM] HITFM [Icons] LO

Front **Seats** Massage Rear

Control	Driver	Psgr.
Lumbar Up/Down	- [Slider] +	- [Slider] +
Lumbar In/Out	- [Slider] +	- [Slider] +
Back Bolster	- [Slider] +	- [Slider] +
Thigh Bolster	- [Slider] +	- [Slider] +



ZONE [Icons]

VOL [Slider]

ZONE [Icons]

TUNE/SCROLL [Slider]

Comfort

START ENGINE STOP



LO [Icons] 1:35 FM HITFM [Icons] LO

Front Seats **Massage** Rear

Waterfall

Lower back **High** High

Med Med

Extend Extend

Low Low

Low extend Low extend

Off Off

Rock climb Rock climb

Driver Psgr.

VOL [Knob] [Home] [Music] **Comfort** [NW] [Phone] [Car] [Grid] [TUNE/SCROLL] [Knob]

[Icons] MAX REAR [Icons] OFF AUTO A/C [Icons]

22.0° Front Seats 22.0°

LO [Icons] 1:35 FM HITFM [Icons] LO

22° Front Seats Massage **Rear** 22°

Lock rear

SYNC to driver Off < 1 2 3 4 5 6 7 > Auto



VOL [Knob] [Home] [Music] **Comfort** [NW] [Phone] [Car] [Grid] [TUNE SCROLL] [Knob]

[Air] [MAX] [REAR] [OFF] [AUTO] [A/C] [Icons]

LO | 1:36 HITFM | LO

Off road | **Controls** | Settings

Mirror Dimmer	2nd row headrest fold	3rd row headrest fold
Pass screen Screen off	Passenger screen power off	Power Side Step
Surround camera	FamCam	Rear View camera

MAX OFF

LO [Icons] 1:36 FM HITFM [Icons] LO

**Vehicle Dynamics**

Steering Angle: 0°

Transfer Case: Unlocked

Rear Axle Locker: Unlocked

**Suspension** 4WD HIGH 55°21'60" E 25°10'07" N Altitude -26 m AUTO

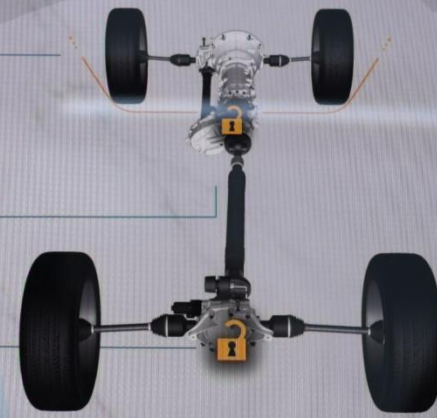

VOL

[Home] [Music] [Phone] [Navigation] [Vehicle] [App Grid]

TUNE/SCROLL

[MAX] [REAR] [A/C] [AUTO]

Vehicle Dynamics

Accessory Gauges

Pitch & Roll

Selec-Terrain

Suspension

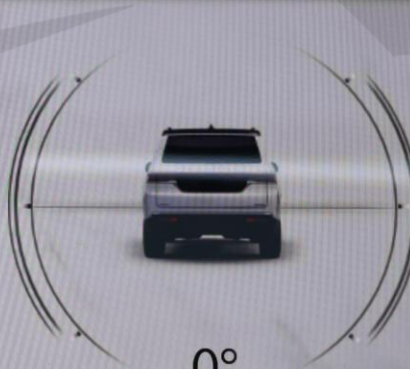
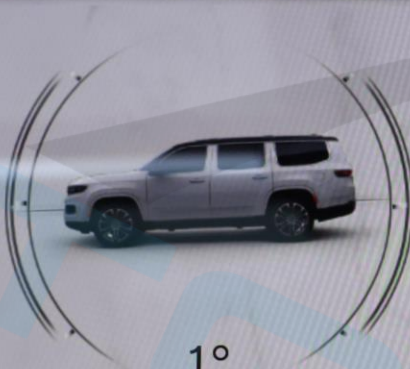

4WD HIGH 55°21'60" E 25°10'07" N Altitude -26 m AUTO

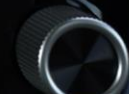

LO 1:37 FM HITFM LO

Vehicle Dynamics

Accessory Gauges

Pitch & Roll

Selec-Terrain

Suspension



4WD HIGH 55°21'60" E 25°10'07" N Altitude -26 m AUTO



NW  
A



Vehicle



TUNE/SCROLL



MAX

REAR



OFF

AUTO

A/C



- Automatic Emergency Braking >
- Display Active Lane Management >
- Entertainment screens ParkSense ⓘ Only warning  Warning + braking assist
- My profile Front ParkSense Volume ⓘ Low  Med  High
- Safety & driving assistance Rear ParkSense Volume ⓘ Low  Med  High



LO [Icons] 13:38 FM HITFM [Icons] LO

Off road Controls Settings

Blind Spot Alert  Off  Lights  Lights + chime

Electric power steering default  Normal  Sport  Comfort

Power Side Step  Auto  Store

Hill Start Assist

Tire Fill Assist

Display

Entertainment screens

My profile

Safety & driving assistance



NW  
A



Vehicle



TUNE/SCROLL

VOL

ZONE

Power icon

Power icon



LO [Icons] 13:38 FM HITFM [Icons] LO

Favourites All

Media

Comfort

Nav

Phone

AM	AM radio	Audio settings	Auxiliary cable	Bluetooth
DAB	DAB	Device Manager	FM radio	Media

ZONE

[Icons]

ZONE

[Icons]

VOL

[Knob]

TUNE/SCROLL

[Knob]

[Home] [Music] [Phone] [NW] [Car] [Apps]

LO [Icons] 13:38 FM HITFM [Icons] LO

Favourites All

Media

Comfort

Nav

Phone

DAB

Device Manager

FM radio

Media

USB 1

USB 2

The image shows a car's infotainment screen with a light-colored background and a grid of application icons. At the top, there is a status bar with 'LO' on both sides, a microphone icon, and the time '13:38'. Below this, a 'Favourites' bar is visible with 'All' selected. The main area contains a vertical sidebar on the left with 'Media', 'Comfort', 'Nav', and 'Phone' buttons. The central area features icons for 'DAB', 'Device Manager', 'FM radio', 'Media', 'USB 1', and 'USB 2'. Each icon is accompanied by a star icon, indicating a favorite or bookmarked item. The 'Device Manager' icon is highlighted with a blue star. The background of the screen shows a faint map.

VOL [Knob]

HOME [Icon]

MUSIC [Icon]

SPORTS [Icon]

NW [Icon]

PHONE [Icon]

CAR [Icon]

Apps [Grid Icon]

TUNE SCROLL [Knob]

This section shows the physical controls and the bottom navigation bar of the infotainment system. On the left, there is a volume knob labeled 'VOL'. On the right, there is a 'TUNE SCROLL' knob. The bottom navigation bar consists of several icons: a home icon, a music icon, a sports icon, a navigation icon labeled 'NW', a phone icon, a car icon, and an 'Apps' icon represented by a grid of dots.

Favourites

All

Media

Comfort

Nav

Phone



Comfort



Driver Heat



Driver Vent



Heated wheel



Massage seats



Psgr heat



Psgr vent



NW  
A



Apps



AUTO

A/C



LO [Icons] 13:38 FM HITFM [Icons] LO

Favourites All

Media

Comfort

Nav

Phone

Android Auto

Device Manager

Phone

Apps

VOL

TUNE/SCROLL

START ENGINE STOP

[Climate and vehicle control icons]

LO [Icons] 13:39 FM HITFM [Icons] LO

Favourites All

- Phone
- Vehicle**
- System
- Other

Ambient Colour	Audio settings	Controls	FamCam
Mirror dimmer	Off Road Pages	Rear view camera	Select. tyre fill alert

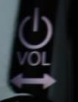

Home Music Navigation Phone Vehicle Apps

MAX REAR [Icons] AUTO A/C [Icons]

Favourites All

- Phone
- Vehicle
- System
- Other

- Settings
- Surround camera
- Vehicle
- 2nd row headrest...
- 3rd row headrest...

Favourites All

Phone

Vehicle

System

Other



Driver profiles



Software updates



Stored Notificati...



NW  
A



Apps



MAX

REAR



OFF

AUTO

A/C



LO [Icons] 13:39 FM HITFM [Icons] LO

Favourites All

- Phone
- Vehicle
- System
- Other



McIntosh



Relax



Tutorials

- Home
- Music
- Activity
- NW A
- Phone
- Car
- Apps

ZONE

[Icons]

ZONE

[Icons]

VOL

[Knob]

TUNE/SCROLL

[Knob]

[Icons]

MAX REAR OFF AUTO A/C



LO | | | 13:41 HITFM | LO

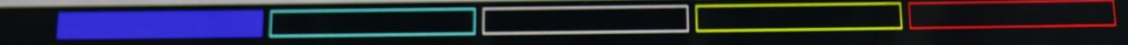

Sync

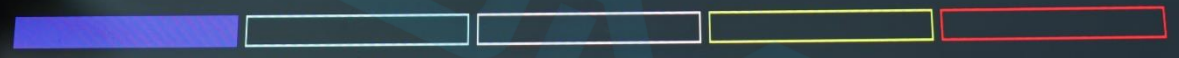

VOL



TUNE/SCROLL



Показать весь доступный диапазон



Вид сверху

Вид сзади

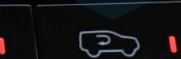
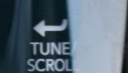

22.0° Front Seats Massage Rear Screen Off 22.0°

Выбрать сиденье, чтобы изменить масштабированный вид

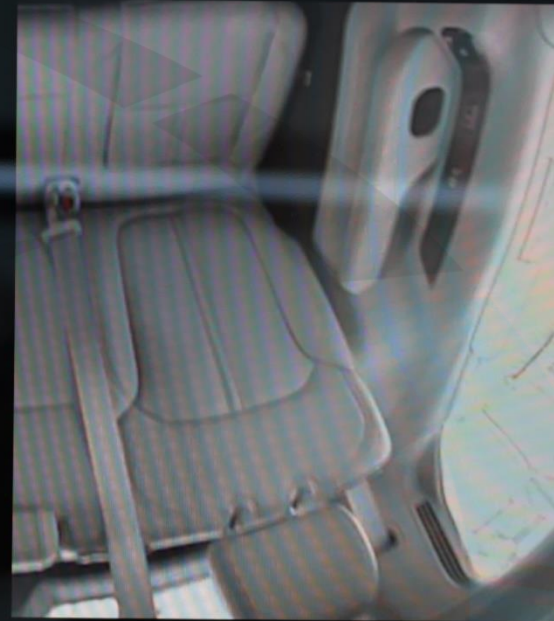

Управление климатом

↑&G

#  
ZONE  
\*  
⏻

↕  
TUNE/  
SCROLL

MAX REAR OFF AUTO A/C

Низ. | | 13:48 HITFM | Низ.

Поиск Street

22 Street 25c Street 23 Street 13b Street  
31 Street 27c Street 36c Street Nadd Al Hamar Road

3D

40

VOL

C3  
▲  
Nav

TUNE  
SCROL

START  
ENGINE  
STOP

### Наклон



1°

### Крен

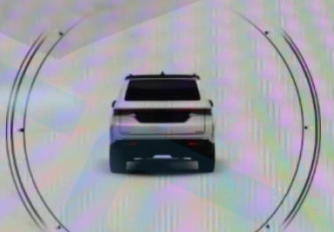

0°

### Подвески

OFF RD 2



Редактировать страницы

Главная



C3  
A



VOL

TUNE  
SCROLL

Передн. Сиденья **Массаж** Задний

Расслабл.

Низ спины

Растягив.

Низ растягив.

**Энергичный**

**Гром.**

Сред.

Низ.

Off



Водит.



Пассаж.

**Гром.**

Сред.

Низ.

Off

Расслабл.

Низ спины

Растягив.

Низ растягив.

**Энергичный**



C3



Низ. 13:47 FM HITFM Низ.

Передн. Сиденья Массаж Задний

Пер. обдув

Об. Вен

Макс. А/С А/С Максим. Задний

Синхр. Off 1 2 3 4 5 6 7 Авт.

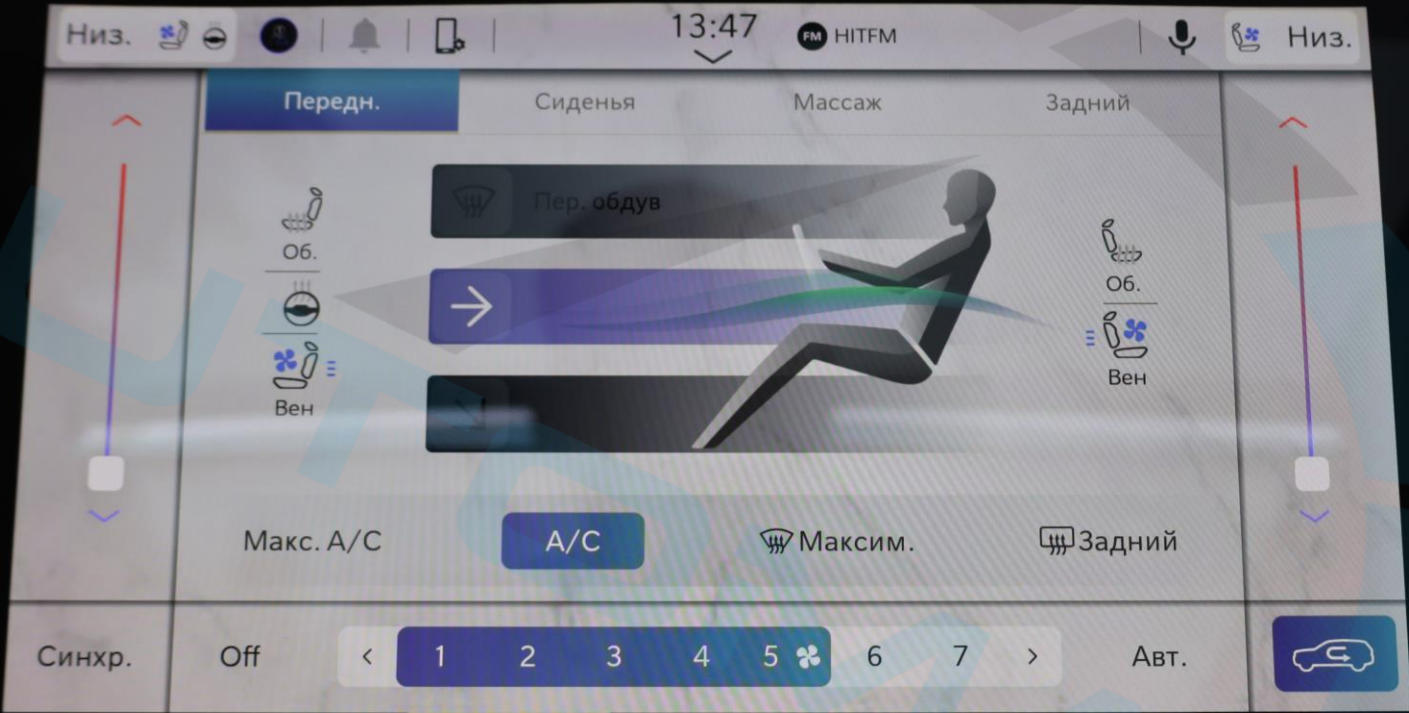

**Динамика  
автомобиля**

Угол поворота  
рулевого колеса:  
0°

**Вспомог.  
приборы**

Раздаточная  
коробка:  
Разблокирована

**Попер.  
перемещения**

**Selec-Terrain**

Блокиратор  
заднего моста:  
Разблокирована

**Подвески**

**4WD HIGH** 55°21'60" В 25°10'07" С Высота -26 м **AUTO**

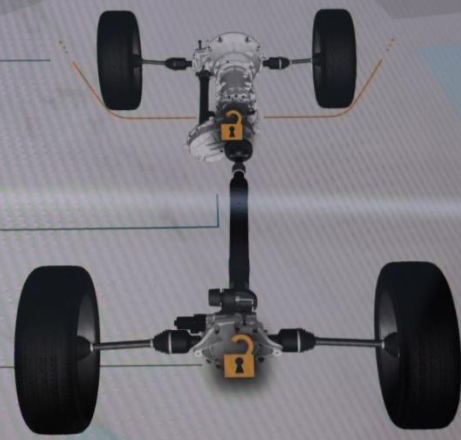

VOL  
↑ ↓



C3  
A



АВТОМ.



TUNE  
SCROLL





تحقق من البيئة المحيطة بأكملها



الرؤية العلوية

الرؤية الخلفية



اختر مقعد لتغيير تكبير العرض



TUNE/SCROLL

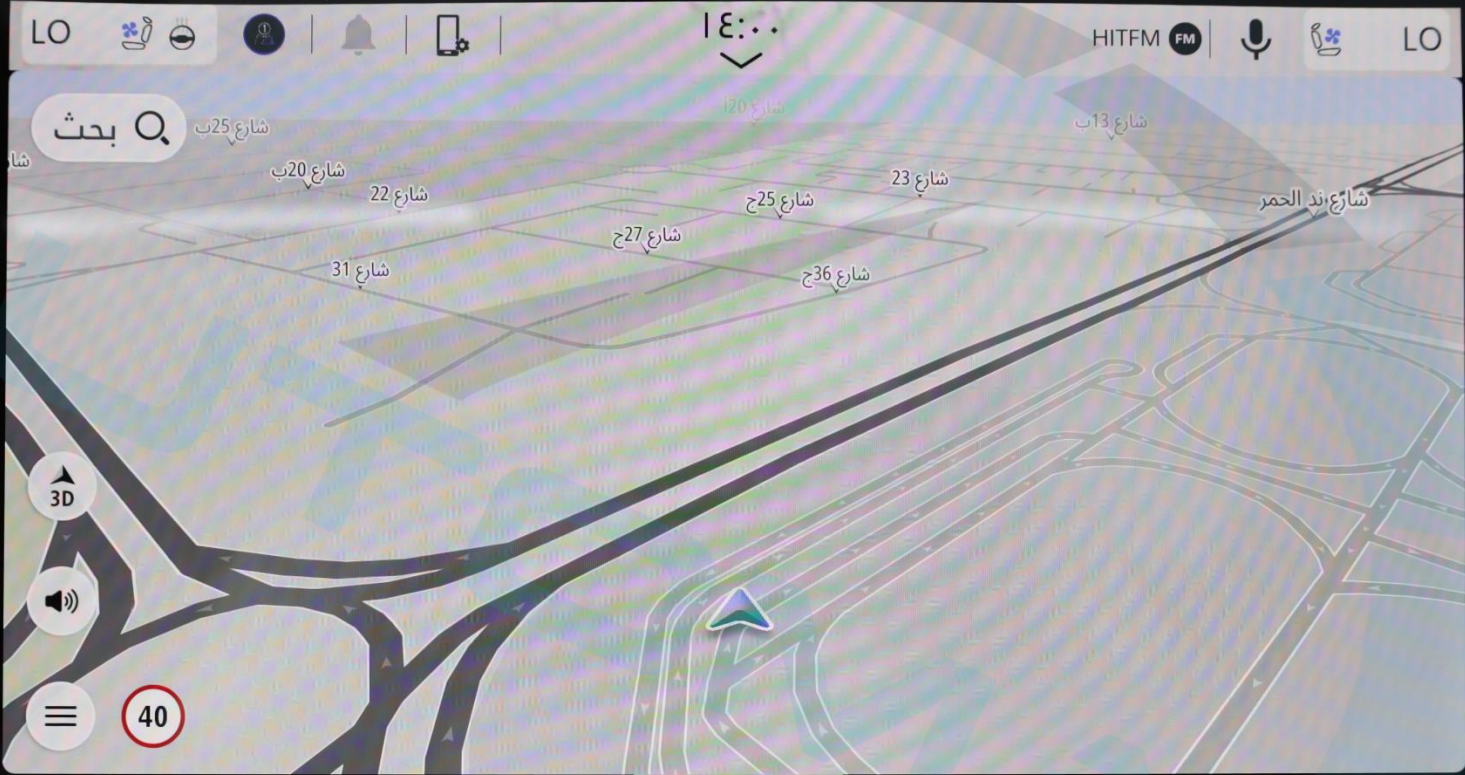

موسيقى  
منازل  
ZONE  
منازل  
موسيقى

موسيقى  
منازل  
ZONE  
منازل  
موسيقى

VOL  
↑ ↓

TUNE/SCROLL  
↑ ↓

START ENGINE STOP

MAX REAR

### نظام التعليق

OFF RD 2



### انحدار

1°

### التفاف

0°



تحرير الصفحات

LO [Icons] 13:09 HITFM FM [Icons] LO

الأمامي المقاعد تدليك خلفي

إزالة الصقيع الأمامي

تسخين تبريد

تسخين تبريد

أقصى تكييف الهواء حد أقصى خلفي

مزامنة Off 1 2 3 4 5 6 7 ألي

ZONE

ZONE

VOL

TUNE/SCROLL

Comfort

LO 14:00 HITFM FM LO

الاسترخاء المقاعد تدليك خلفي الاسترخاء

الاسترخاء

أسفل الظهر

تمديد

تمديد أسفل الظهر

شديد

عالي

متوسط

منخفض

Off

السائق

الراكب

عالي

متوسط

منخفض

Off

الاسترخاء

أسفل الظهر

تمديد

تمديد أسفل الظهر

شديد



NW  
A



Comfort



TUNE/  
SCROLL

LO | ١٤:٠٠ | HITFM FM LO

الأمامي المقاعد تدليك **خلفي**

٥٢٢ ٥٢٢

قفل الخلفي

المزامنة مع السائق Off < 1 2 3 4 5 6 7 > آلي

ZONE

ZONE

VOL

TUNE/SCROLL

NW

LO



١٤:٠٦

HITFM FM



LO

ديناميكيات  
المركبة

زاوية التوجيه:  
0°

ملحقات  
المقاييس

حالة النقل:  
غير مغلق

انحدار و  
التفاف

Selec-Terrain

قفل المحور  
الخلفي:  
غير مغلق

نظام التعليق

4WD  
HIGH

55°21'60" E

25°10'07" N

ارتفاع -26 m

AUTO

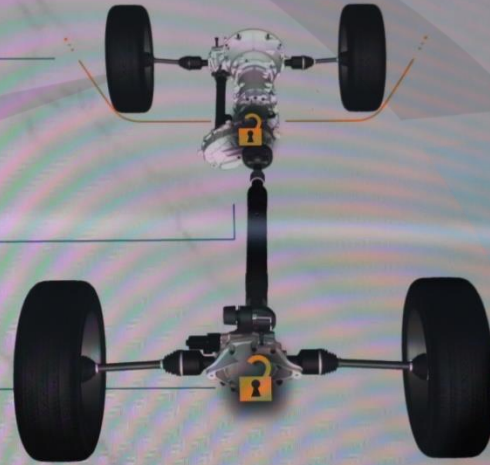

المركبة



NW  
A



VOL



TUNE/  
SCROLL







Тел.



АВТОМ.

Система



Navigation arrows, MAX, REAR, OFF, AUTO, A/C, Car icon, Navigation arrows

LO      Front      Seats      Massage      Rear      Screen Off      LO

Front Defrost

→

↘

Sync    Off    1    2    3    4    5    6    7    Max A/C

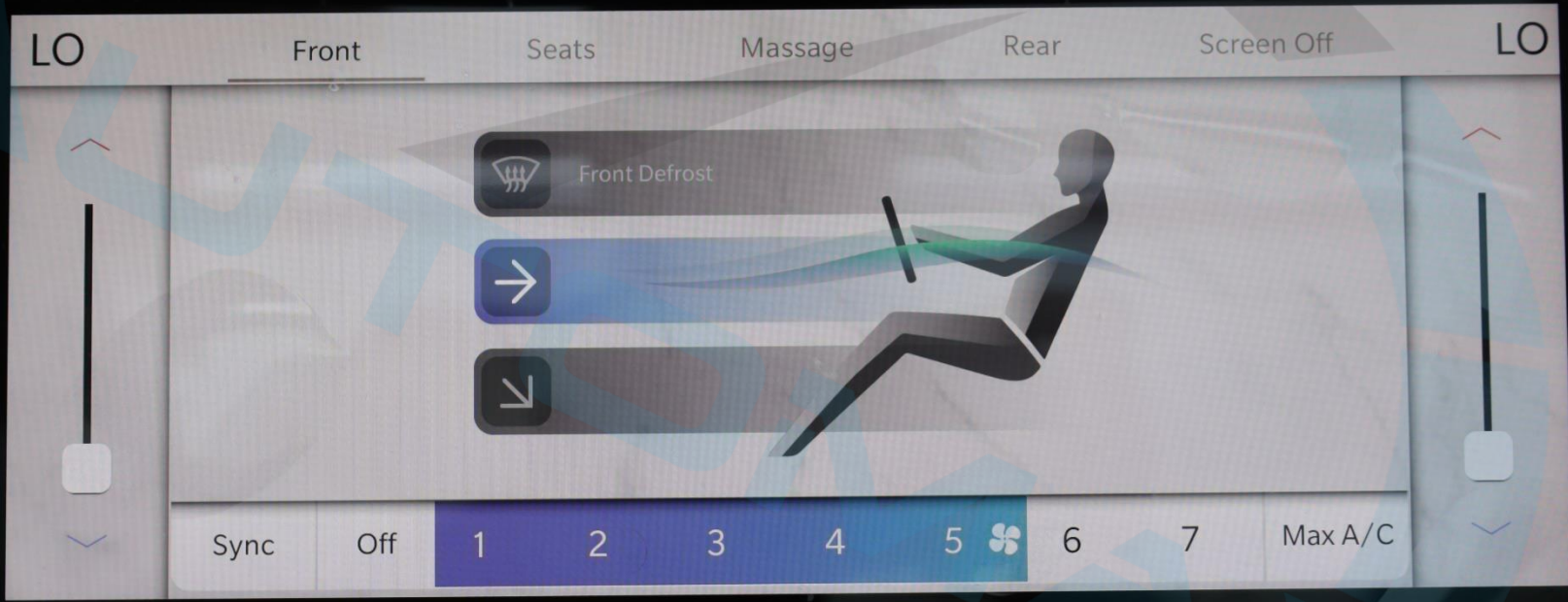

Navigation arrows, MUTE, AUTO HOLD ON, OFF, OFF, P ON, OFF, TOW/HAUL ON, Navigation arrows



MAX

REAR



AUTO

A/C



Front      Seats      Massage      Rear      Screen Off

	Lumbar Up/Down				Lumbar Up/Down	
	Lumbar In/Out				Lumbar In/Out	
	Back Bolster				Back Bolster	
	Thigh Bolster		Driver		Passenger	



MUTE



AUTO HOLD ON



ON

OFF

TOW HAUL ON





AUTO

A/C



Front Seats Massage Rear Screen Off

Waterfall	High	<p>Driver</p>	<p>Passenger</p>	High	Waterfall
Lower Back	Med			Med	Lower Back
Extend	Low			Low	Extend
Low Extend	Off			Off	Low Extend
Rock Climb					Rock Climb



MUTE



AUTO HOLD ON



P ON



TOW/HAIL ON



P

Home



Controls

Vehicle cameras

Fam Cam

Rear View

Check entire surrounding

Top View

Rear View

Surround View

AND WAGON

Home

Controls

Audio 

---

 Bluetooth

 FM

 AM

More...

Video 

---

 USB 1

 USB 2

More...

HDMI 

---

**HDMI**  
HIGH DEFINITION MULTIMEDIA INTERFACE



Connect HDMI cable

Home



Controls

### Navigation



Search



Favourites

Recent

### Devices



0 devices connected



Pair new device



Manage Bluetooth headphones

### Cameras

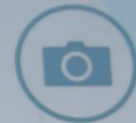

View vehicle  
Camera apps



W A G O

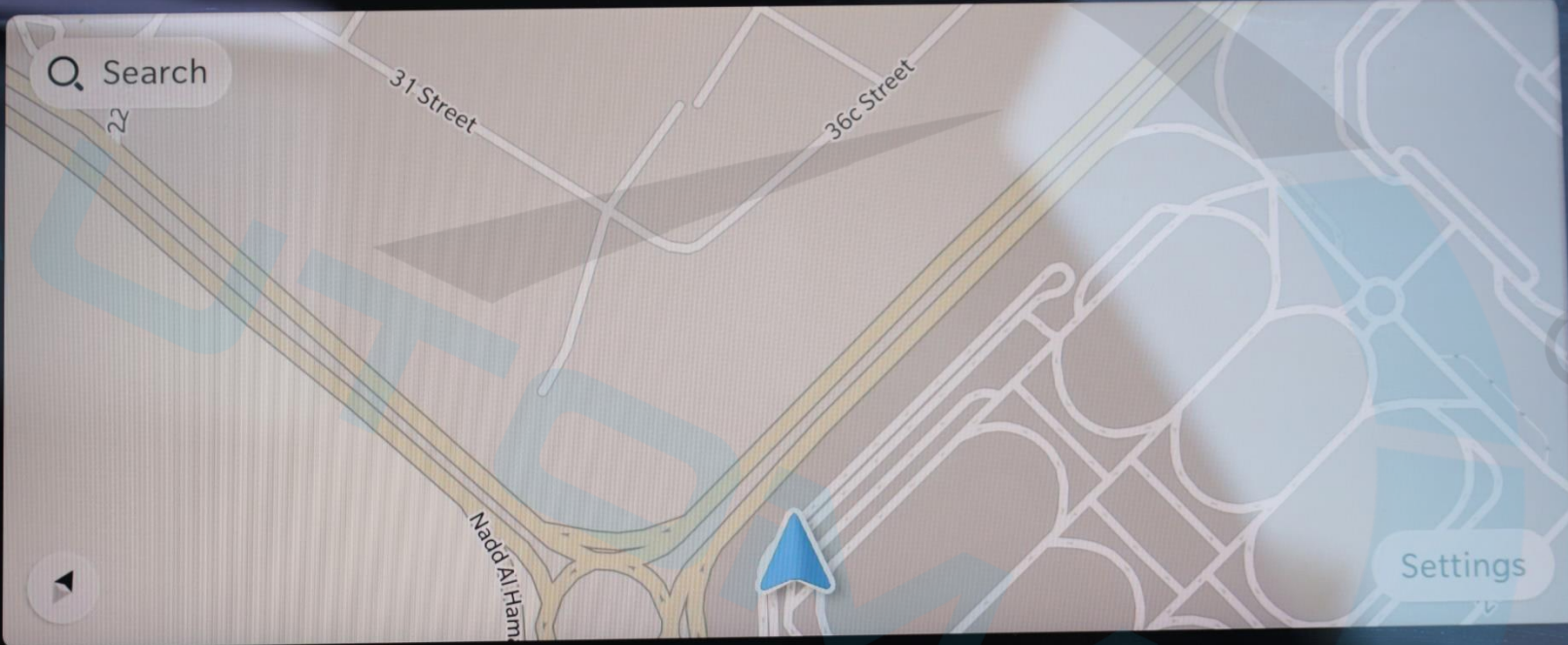

Home

Controls

Search

31 Street

36c Street

Nadd Al Ham

Settings

C R A N D W A G O N





Sync

Off

1

2

3

4

5



6

7

Max A/C



MUTE



OFF

AUTO  
HOLD  
ON



OFF



OFF



ON



OFF

TOW/  
HAUL  
ON



P R N D

ROCK  
SAND/MUD  
SNOW  
AUTO  
SPORT



Sync Off 1 2 3 4 5 6 7 Max A/C

MAP AUTO OFF AUTO HOLD ON L4 OFF TRIP ON OFF PWR HOLD ON OFF TOW HACE ON

P R N D

ROCK  
SAND/MUD  
SNOW  
AUTO  
SPORT

←  
|  
|  
|  
|  
→

4WD  
LOW

4x4

4N



22.0°

Rear Comfort

Screen Off

22.0°

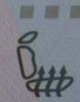
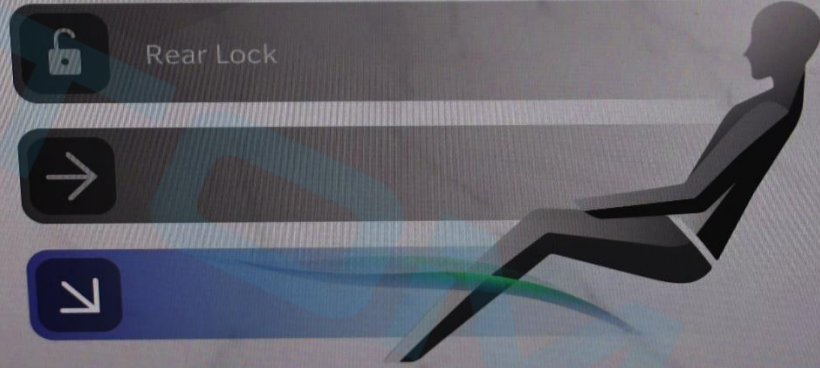

Sync

Off

1

2

3

4



5

6

7

Auto

230 V AC  
150 W



  
12V DC



GRAND WAGON E





















START  
ENGINE  
STOP

RUN









12V DC





AUTO

P

R

N

D

P

PULL ON





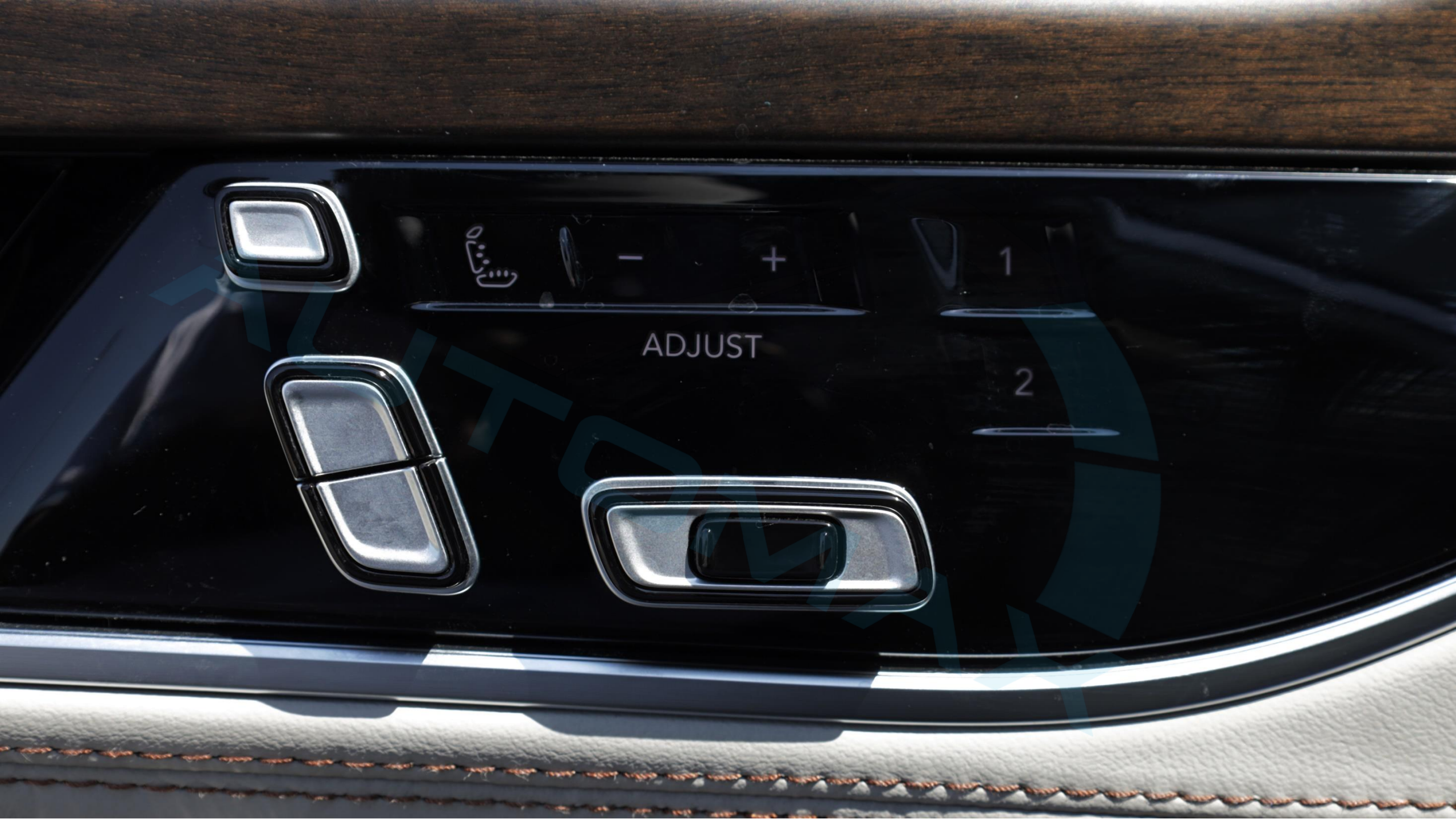

ADJUST

1

2



Infosh















P:810 SEQ:447200  
PS530342 68400498AA



GRAND WAGONEER











GR





لمشاهدة صورة السيارة بزاوية 360 درجة إضغط على الصورة أعلاه

Для просмотра автомобиля в формате 360°, пожалуйста, нажмите на фото выше.

To view the 360° degree please press on the picture above

# 2023 JEEP GRAND WAGONEER SERIES II 16 3.0L TT 4X4 GCC 0Km

Бренд: Jeep

Brand: Jeep

الماركة: جيب

Категория: GRAND WAGONEER

Category: GRAND WAGONEER

الفئة: GRAND WAGONEER

Модель: SERIES II LUXURY

Model: SERIES II LUXURY

الموديل: SERIES II LUXURY

Год: 2023

Year: 2023

السنة: 2023

Километров: 0 Km

Kilometers: 0 Km

كيلومترات: 0 كم

Двери: 4 Doors

Doors: 4 Doors

عدد الأبواب: 4 أبواب

Цвет: Синий

Color: Midnight Sky/ Sea Salt

اللون: ليلي داكن

Цилиндр: 6

Cylinder: 6 Cylinders

عدد الأسطوانات: 6 أسطوانات

Лошадиные силы: 510 HP

Horsepower: 510 HP

عدد الأحصنة: 510 حصان

Трансмиссия: Автоматическая

Transmission: Automatic

نوع النقل: نقل أوتوماتيكي

Топливо: Бензин

Fuel: Gasoline

نوع الوقود: بنزين

4X4

4X4

4X4

GCC

المواصفات خليجية

# 2023 JEEP GRAND WAGONEER SERIES II 16 3.0L TT 4X4 GCC 0Km

LEATHER TRIMMED BUCKET SEATS  
SEA SALT/BLACK  
MIDDLE EAST EQUIPMENT GROUP  
OFF ROAD GROUP II  
FLEXIBLE SEATING GROUP  
AUX BATTERY  
40/20/40 2ND ROW BENCH PWR TIP/SLIDE  
REMOVABLE ASH TRAY  
8 PASSENGER SEATING  
8-SPD AUTO 8HP75 TRANS (BUY-US)  
3.0L 16 HURRICANE HO TWIN TURBO ESS  
AUTO DIM EXTERIOR DRIVER MIRROR  
CIGAR LIGHTER  
GPS NAVIGATION  
GPS ANTENNA INPUT  
ACTIVE NOISE CONTROL SYSTEM  
EXT. MIRRORS W/SUPPLEMENTAL SIGNALS  
EXTERIOR MIRRORS W/ARABIC LETTERING  
EXTERIOR MIRRORS W/MEMORY  
AUTO ADJUST IN REVERSE EXT MIRRORS

HEATED EXTERIOR MIRRORS  
EXTERIOR MIRRORS APPROACH LAMPS  
BLACK ROOF  
QUADRA DRIVE II BADGE  
U.S. EMISSIONS W/OBD I  
INTEGRATED TIRE COMPRESSOR KIT  
MIDNIGHT SKY  
ALL RADIO EQUIPPED VEHICLES  
12.0" TOUCHSCREEN DISPLAY  
FRONT PASSENGER INTERACTIVE DISPLAY  
2ND ROW DUAL CHG-ONLY USB PORTS  
DIGITAL AUDIO BROADCASTING  
ALL R1 HIGH RADIOS  
BRIDGESTONE BRAND TIRES  
ALL ALUMINUM WHEELS  
FUEL TANK SKID PLATE SHIELD  
TRANSFER CASE SKID PLATE SHIELD  
FRONT AXLE SKID PLATE  
STOP-START DUAL BATTERY SYSTEM  
10 ADDITIONAL GALLONS OF GAS

# 2023 JEEP GRAND WAGONEER SERIES II 16 3.0L TT 4X4 GCS OKm

Quadra Drive II

INTEGRATED TIRE COMPRESSOR KIT

ADJUSTABLE ROOF RAIL CROSSBARS

8 местный

Зимний Пакет

Gear Limit

Вентиляция Сидений

Подогрев Сидений

Сиденья с функцией массажа

Рулевое Колесо с Подогревом

Регулируемые Сиденья с Памятью Позций

Дистанционный Запуск Двигателя

Система Мониторинга Слепых Зон

Бесключевой Доступ

Регулировка Режимов Вождения

Подрулевые Лепестки

Пневмоподвеска

Дистанционное управление пневмоподвеской

Адаптивный Круиз-контроль

ДИСПЛЕЙ ДЛЯ ПАССАЖИРА

Камера Наблюдения Внутри Салона

Холодильник

Контурная Подсветка Салона

Система Экстренного Торможения

Контроль Полосы Движения

Проекция на лобовое стекло

MCINTOSH Премиальная Мультимедийная Система С 19-МИ ДИНАМИКАМИ

Камера 360 Градусов

Панорамная Крыша

Беспроводная Зарядка

Система Помощи При Спуске с Горы

Датчик Давления в Шинах

Розетка

Задние Шторки

Система «Старт-Стоп»

Выдвижная Боковая Подножка

Автопарковка

R 20"

Apple Carplay + Android Auto



# 2023 JEEP GRAND WAGONEER SERIES II 16 3.0L TT 4X4 GCC 0Km

\* الأداء:

ناقل حركة أوتوماتيكي ب 8 سرعات

عدد الأسطوانات: 6 أسطوانات

سعة المحرك: 3.0 توين توربو

العزم: 677 نيوتن.متر

عدد الأحصنة: 510 حصان

دفع رباعي 4X4

\* المواصفات الإضافية:

Quadra Drive II

Gear Limit

INTEGRATED TIRE COMPRESSOR KIT

ADJUSTABLE ROOF RAIL CROSSBARS

8 مراتب

كاميرا بزاوية 360 درجة

شاشة بروجكتر أمامي

شاشة إضافية للمرافق

ثلاجة أمامية

عداد ديجيتال

مثبت السرعة التكميلي

نظام الهيدروليك لرفع و خفض المركبة مع خاصية التحكم عن بعد

نظام صوتي متقدم من MCINTOSH مع 19 سماعة

خاصية التبريد والتدفئة للمراتب

خاصية المساج للمراتب

فتحة سقف بانوراما مزدوجة

خاصية تثبيت المسار

كاميرا داخلية بزاوية 180 درجة

نظام الملاحة وتحديد المواقع

# 2023 JEEP GRAND WAGONEER SERIES II 16 3.0L TT 4X4 GCC 0Km

خاصية الكشف عن النقطة العمياء

أوتو بارك

التشغيل عن بعد

دخول بصمة

خاصية تدفئة المقود

خاصية المساعدة في نزول المنحدرات

نظام البطارية المزدوجة للبدء والتوقف

نظام مكابح متقدم مع الفرامل التلقائية

وضعية قيادة متعددة

مراتب كهربائية متعددة الوضعية مع خاصية الذاكرة

وحدة تكييف خلفية منفصلة

ابل كاربلاي

اندرويد أوتو

إنارة داخلية محيطيه

دبّة كهربائية مع حساس قدم

مخارج طاقة كهربائية متعددة

شاحن هاتف لاسلكي

ستائر خلفية

عتبات جانبية كهربائية

جنوط مقاس 20 بوصة

# AUTOMAX®

The Boutique Of Muscle Cars, Truck Fanatics & German Automotive Experts.



نتكلم اللغة العربية

**WE SPEAK ENGLISH**

**ON PARLE LE FRANCAIS**

**Nosotros hablamos español**

мы говорим по-русски

**biz o'zbek tilida**

**gaplashamiz**

हम हिंदी बोलते हैं



**automaxgroup.me**



**automax group**



**automax.dxb**



**Automax\_LLC**



**+971 50 602 7200**



**automax.dxb**



**automax.dxb**



**automax.dxb**



**automax\_dxb**



**automax group L.L.C**

**New Auto Market - Dubai - United Arab Emirates**

 **Directions**