







GRAND WAGONEER

AUTOMAX
AUTOMAX ج.م.س. ٤٣ ٩٤ ٥٥٥٥٤٦٧٧٧



GRAND WAGONEER

AUTOMAR

GRAND WAGONEER



GRAND WAGONEER





GRAND WAGONEER

GRAND WAGONEER

AUTOMAX







GRAND WAGONEER

AIRBAG

SET+
CANC RES
SET-

GEAR
LIMIT

Top View

START
ENGINE
STOP



SET+



CANC



RES



SET-



- GEAR
LIMIT +



0

km/h

1. Driver info

P

37°C

NW



OFF RD



Driver Assist
Press Ok to Zoom In



1. Driver info



Hold OK for Digital

0

km/h
OK for MPH

Speedometer
80 km

P



OFF RD 2

ON OFF

OFF

OFF

NW

5. Off Road



AUTO

Automatic Full
Time 4WD
Adapts to
Road Conditions



P

37°C

OFF RD 2

Maximum
Ground Clearance



Terrain Status
80 km



4. Navigation

NW



P

37°C

OFF RD



80 km

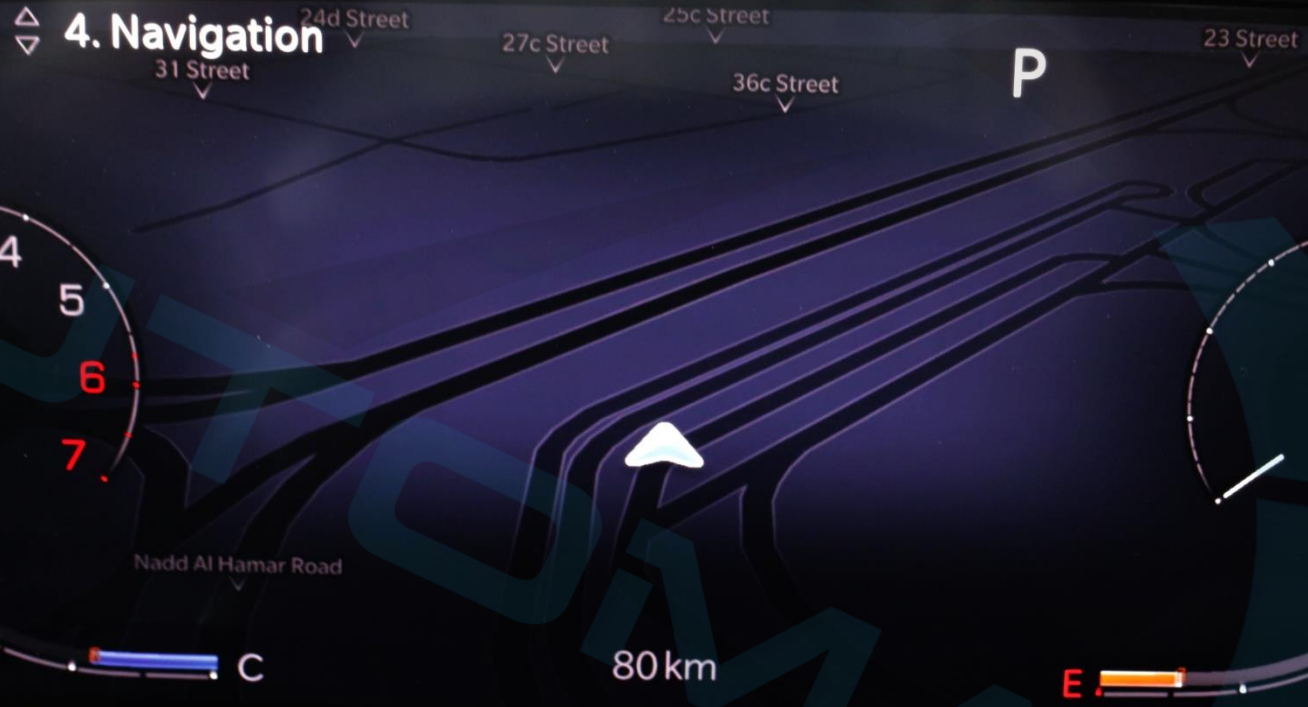

Check entire surroundings



Top View

Rear View



TUNE/
SCROLL



Select a seat to change zoom view

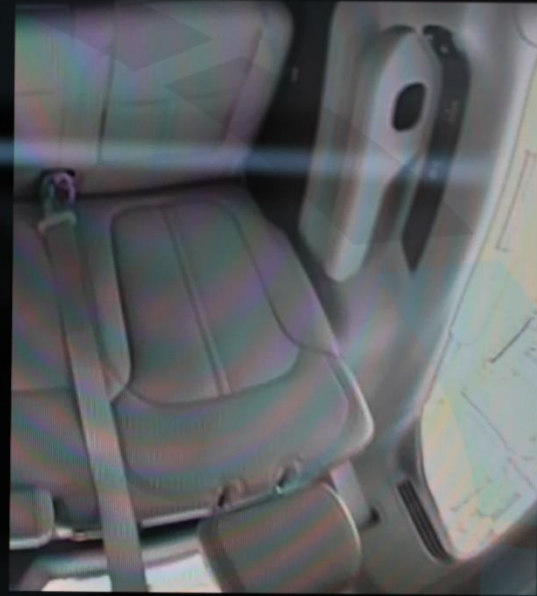

Volume control knob with VOL icon and up/down arrows.

TUNE/SCROLL knob with up/down arrows and a power button icon.

Climate control panel with buttons for MAX, REAR, OFF, AUTO, and A/C.

Map interface with search bar and street names:

- Search
- 18a Street
- 7 Street
- 23 Street
- 25c Street
- 27c Street
- 36c Street

Radio player interface:

- HITFM
- HITFM ARN NETWORK - 044...
- All presets
- Play/Pause controls

Phone pairing interface:

- Phone
- Select 'Add Device' to start the pairing process.
- Add device
- Device Manager

Home button and Edit pages:

- Edit pages
- Home



Pitch



1°

Roll

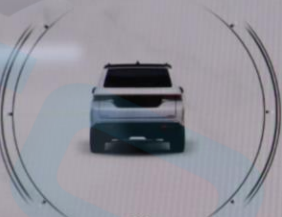

0°

Suspension

OFF RD 2



Edit pages

Home



NW
A



Volume knob with 'vol' label and up/down arrows.

TUNE SCROLL knob with up/down arrows and 'TUNE SCROLL' label.

LO [Icons] 1:34 FM HITFM [Icons] LO

Front Seats Massage Rear

Front defrost

Heat

Vent

Heat

Vent

Max A/C A/C Max Rear

Sync Off < 1 2 3 4 5 6 7 > Auto [Car Icon]

ZONE

VOL

ZONE

TUNE/SCROLL

Home Music Comfort NW A [Car Icon] [Grid Icon]

Wednesday, 2 October 2024 [Settings]

Shortcut menu with icons for: Sync, [Icon 1], [Icon 2], [Icon 3], [Icon 4]

shortcuts

Icons to drag to status bar above

37° OUT
Temperature

Profiles

Notifications

Fam Cam

Device Manager



LO [Icons] 1:34 [FM] HITFM [Icons] LO

Front **Seats** Massage Rear

Control	Driver	Psgr.
Lumbar Up/Down	- [Slider] +	- [Slider] +
Lumbar In/Out	- [Slider] +	- [Slider] +
Back Bolster	- [Slider] +	- [Slider] +
Thigh Bolster	- [Slider] +	- [Slider] +



Driver Psgr.

Physical controls on the left and right sides of the screen, including volume knobs, touch-sensitive buttons for 'ZONE', 'TUNE/SCROLL', and a power button.

START ENGINE STOP

Bottom navigation bar with icons for Home, Music, Comfort (active), Navigation (NW), Phone, Vehicle, and App Grid.

LO [Icons] 1:35 FM HITFM [Icons] LO

Front Seats **Massage** Rear

Waterfall

Lower back **High** High

Med Med

Extend Extend

Low extend Low

Off Off

Rock climb Rock climb

Driver Psgr.

VOL [Home] [Music] **Comfort** [NW] [Phone] [Car] [Grid] TUNE/SCROLL

[Icons] MAX REAR [Icons] OFF AUTO A/C [Icons]

22.0° Front Seats 22.0°

LO [Icons] 1:35 FM HITFM [Icons] LO

22° Front Seats Massage **Rear** 22°

Lock rear

→

↙

SYNC to driver Off < 1 2 3 4 5 6 7 > Auto

VOL [Knob] [Home] [Music] **Comfort** [NW] [Phone] [Car] [Grid] [TUNE SCROLL] [Knob]

[Vents] [MAX] [REAR] [Massage] [OFF] [AUTO] [A/C] [Icons] [Vents]

LO | 1:36 HITFM | LO

Off road | **Controls** | Settings

Mirror Dimmer	2nd row headrest fold	3rd row headrest fold
Pass screen Screen off	Passenger screen power off	Power Side Step
Surround camera	FamCam	Rear View camera

ZONE

LO [Icons] 1:36 FM HITFM [Icons] LO

Vehicle Dynamics

Steering Angle: 0°

Transfer Case: Unlocked

Rear Axle Locker: Unlocked

Suspension 4WD HIGH 55°21'60" E 25°10'07" N Altitude -26 m AUTO

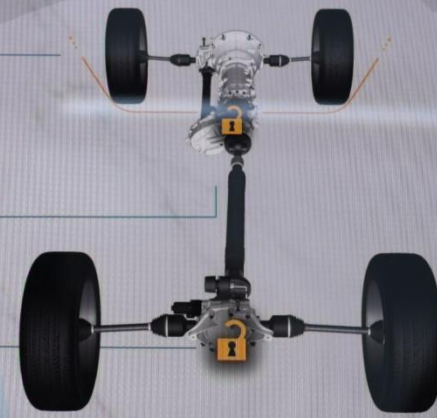

VOL

Home Music Phone NW A Vehicle [Grid]

TUNE/SCROLL

[MAX] [REAR] [Icons] [AUTO] [A/C]

Vehicle Dynamics

Accessory Gauges

Pitch & Roll

Selec-Terrain

Suspension

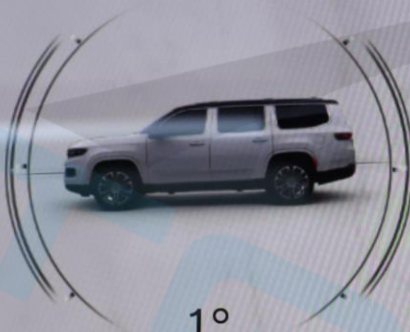

Pitch

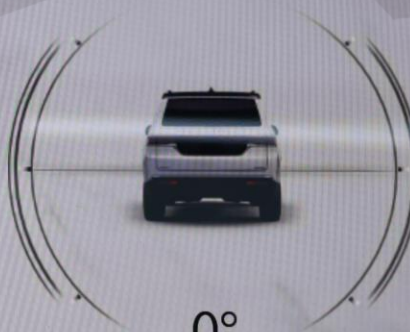

Roll

4WD HIGH 55°21'60" E 25°10'07" N Altitude -26 m AUTO



Vehicle

LO 1:37 FM HITFM LO

Vehicle Dynamics

Accessory Gauges

Pitch & Roll

Selec-Terrain

Suspension



4WD HIGH 55°21'60" E 25°10'07" N Altitude -26 m AUTO



NW
A



Vehicle



TUNE/SCROLL

MAX REAR OFF AUTO A/C

- Automatic Emergency Braking >
- Display Active Lane Management >
- Entertainment screens ParkSense ⓘ Only warning Warning + braking assist
- My profile Front ParkSense Volume ⓘ Low Med High
- Safety & driving assistance Rear ParkSense Volume ⓘ Low Med High

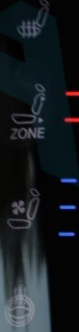

LO [Icons] 13:38 FM HITFM [Icons] LO

Off road Controls Settings

Blind Spot Alert Off Lights Lights + chime

Electric power steering default Normal Sport Comfort

Power Side Step Auto Store

Hill Start Assist

Tire Fill Assist

VOL

[Volume Knob]

[Home] [Music] [Sport] [NW] [Phone] [Vehicle] [App Grid]

TUNE/SCROLL

[Tune/Scroll Knob]

START ENGINE STOP

[Start Button]

LO [Icons] 13:38 FM HITFM [Icons] LO

Favourites All

Media

Comfort

Nav

Phone

AM	AM radio	Audio settings	Auxiliary cable	Bluetooth
DAB	DAB	Device Manager	FM radio	Media

ZONE

[Icons]

ZONE

[Icons]

VOL

[Knob]

TUNE/SCROLL

[Knob]

[Home] [Music] [Phone] [NW] [Car] [Apps]

LO [Icons] 13:38 FM HITFM [Icons] LO

Favourites All

Media Comfort Nav Phone

DAB DAB Device Manager FM radio Media

USB 1 USB 2

VOL

TUNE SCROLL

Home Music Sport NW Car Apps

Favourites

All

- Media
- Comfort**
- Nav
- Phone



Comfort



Driver Heat



Driver Vent



Heated wheel



Massage seats



Psgr heat



Psgr vent



NW



Apps

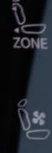
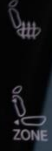
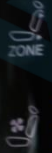
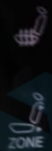

AUTO

A/C



LO [Icons] 13:38 FM HITFM [Icons] LO

Favourites All

Media

Comfort

Nav

Phone

Android Auto

Device Manager

Phone

Apps

VOL

TUNE/SCROLL

START ENGINE STOP

[Climate and vehicle control icons]

LO [Icons] 13:39 FM HITFM [Icons] LO

Favourites All

- Phone
- Vehicle**
- System
- Other

Ambient Colour	Audio settings	Controls	FamCam
Mirror dimmer	Off Road Pages	Rear view camera	Select. tyre fill alert

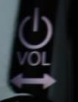

Home Music Navigation Phone Vehicle Apps

MAX REAR [Icons] AUTO A/C [Icons]

Favourites All

- Phone
- Vehicle
- System
- Other

- Settings
- Surround camera
- Vehicle
- 2nd row headrest...
- 3rd row headrest...

Favourites All

Phone

Vehicle

System

Other



Driver profiles



Software updates



Stored Notificati...



VOL

TUNE / SCROLL



NW



Apps



MAX

REAR



OFF

AUTO

A/C



LO [Icons] 13:39 FM HITFM [Icons] LO

Favourites All

- Phone
- Vehicle
- System
- Other



McIntosh



Relax



Tutorials

- Home
- Music
- Activity
- NW A
- Phone
- Car
- Apps

ZONE

[Icons]

ZONE

[Icons]

VOL

[Knob]

TUNE/SCROLL

[Knob]

[Icons]

MAX REAR OFF AUTO A/C

LO | | | 13:41 FM HITFM | LO

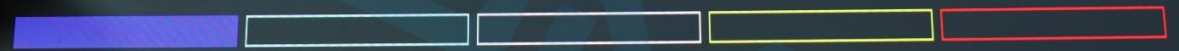
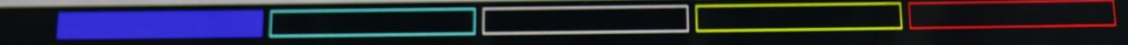

VOL

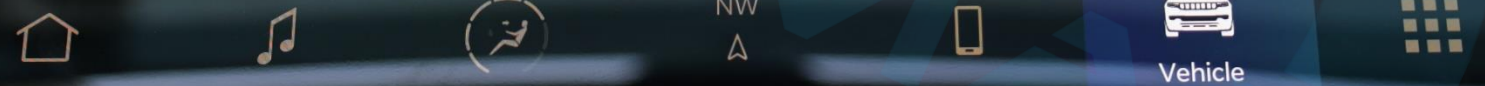

TUNE/SCROLL



Показать весь доступный диапазон



Вид сверху

Вид сзади



VOL

TUNE SCROLL



22.0°

Front

Seats

Massage

Rear

Screen Off

22.0°

Выбрать сиденье, чтобы изменить масштабированный вид



Управление климатом

↑&G

ZONE
*
⏻

↕
TUNE/
SCROLL

MAX REAR OFF AUTO A/C

Низ. | | 13:48 HITFM | Низ.

Поиск Street

22 Street 25c Street 23 Street 13b Street
31 Street 27c Street 36c Street Nadd Al Hamar Road

3D

40

VOL

C3
▲
Nav

TUNE SCROL

START ENGINE STOP

Наклон



1°

Крен

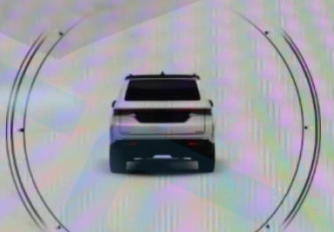

0°

Подвески

OFF RD 2



Редактировать страницы

Главная



C3
A



VOL

TUNE
SCROLL

Передн. Сиденья **Массаж** Задний

Расслабл.

Низ спины

Растягив.

Низ растягив.

Энергичный

Гром.

Сред.

Низ.

Off



Водит.



Пассаж.

Гром.

Сред.

Низ.

Off

Расслабл.

Низ спины

Растягив.

Низ растягив.

Энергичный



Comfort

C3



Низ. 13:47 FM HITFM Низ.

Передн. Сиденья Массаж Задний

Пер. обдув

Об. Вен

Макс. А/С А/С Максим. Задний

Синхр. Off 1 2 3 4 5 6 7 Авт.

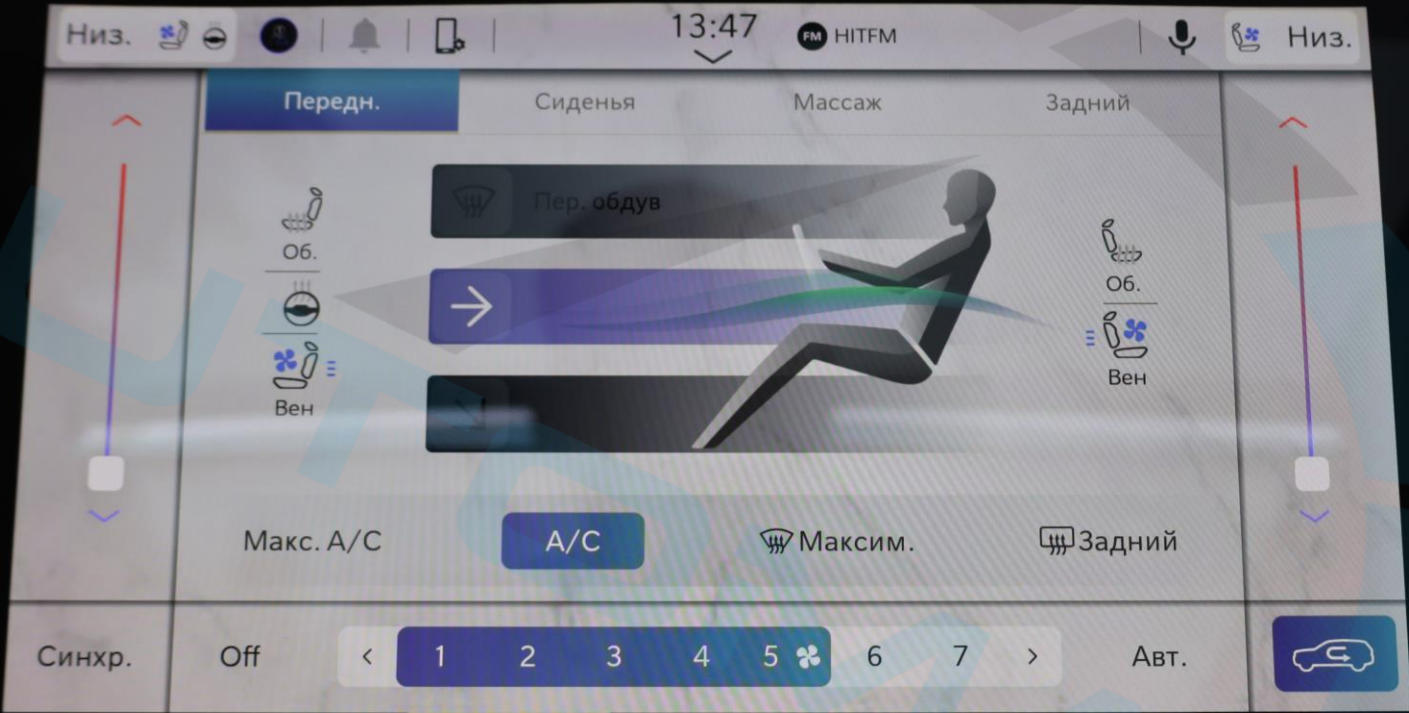

**Динамика
автомобиля**

Угол поворота
рулевого колеса:
0°

**Вспомог.
приборы**

Раздаточная
коробка:
Разблокирована

**Попер.
перемещения**

Selec-Terrain

Блокиратор
заднего моста:
Разблокирована

Подвески

4WD HIGH 55°21'60" В 25°10'07" С Высота -26 м AUTO

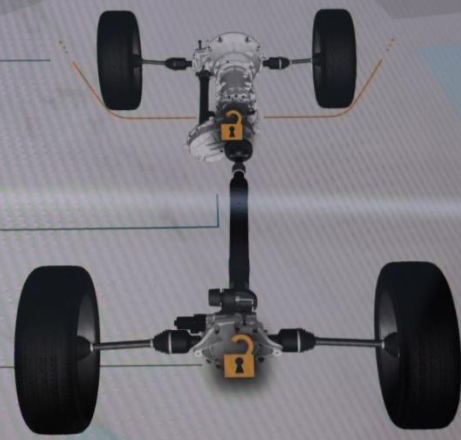

VOL
↑ ↓



C3
A



АВТОМ.



TUNE
SCROLL



تحقق من البيئة المحيطة بأكملها



الرؤية العلوية

الرؤية الخلفية

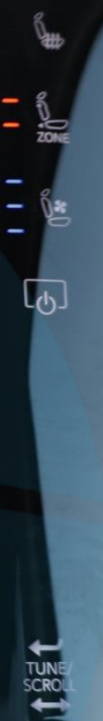
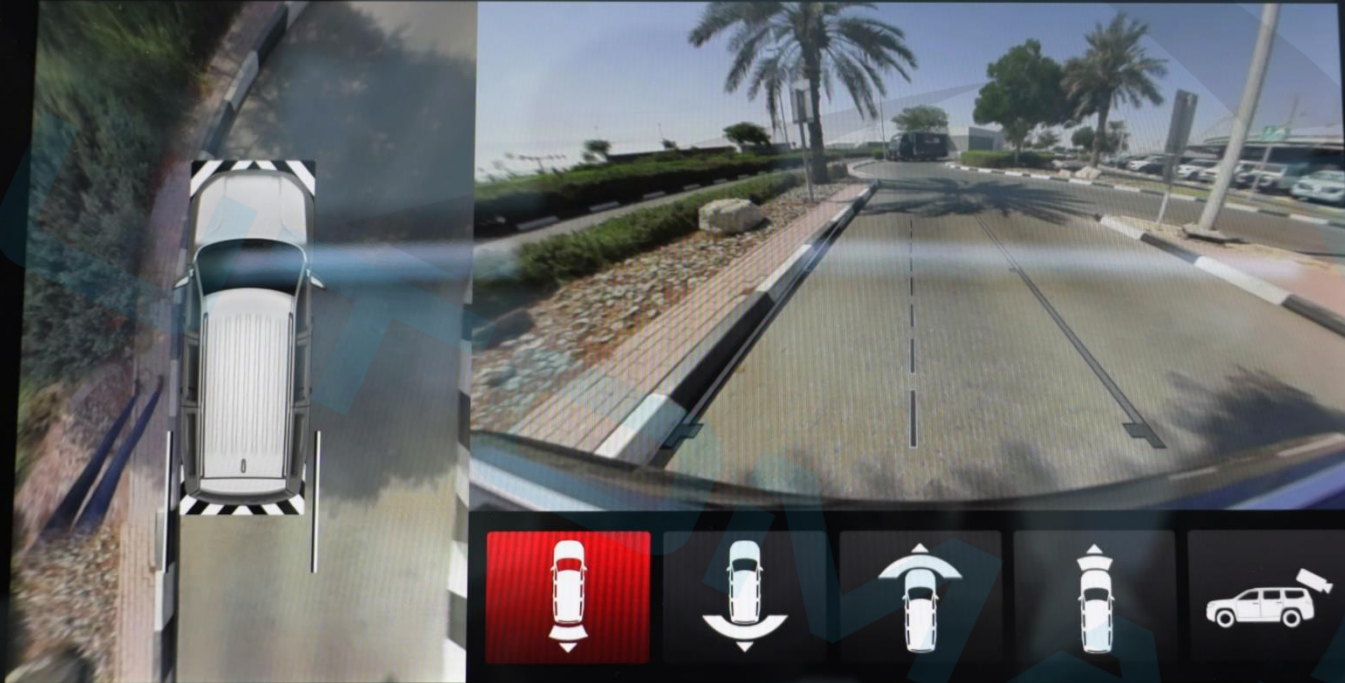

اختر مقعد لتغيير تكبير العرض



TUNE/SCROLL

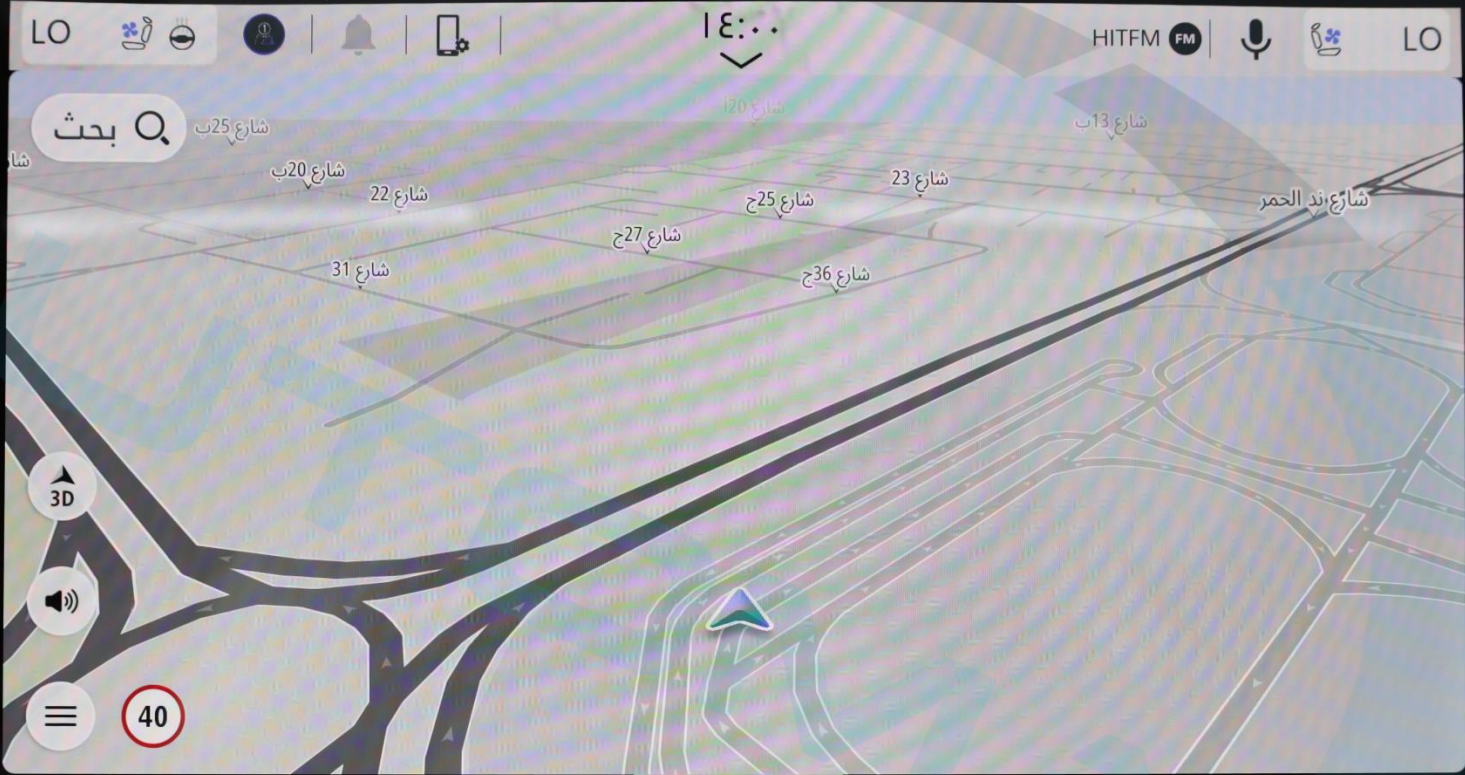

موسيقى
منازل
ZONE
منازل
موسيقى

موسيقى
منازل
ZONE
منازل
موسيقى

VOL
↑ ↓

TUNE/SCROLL
↑ ↓

START ENGINE STOP

MAX REAR

نظام التعليق

OFF RD 2



انحدار

1°

التفاف

0°



تحرير الصفحات

VOL [Up/Down]



NW
▲



الرئيسية

TUNE
SCROLL

LO [Icons] 13:09 HITFM FM [Icons] LO

الأمامي المقاعد تدليك خلفي

إزالة الصقيع الأمامي

تسخين تبريد

تسخين تبريد

أقصى تكييف الهواء حد أقصى خلفي

مزامنة Off 1 2 3 4 5 6 7 ألي

ZONE

ZONE

VOL

TUNE/SCROLL



NW

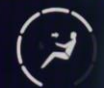

Comfort



LO | ١٤:٠٠ | HITFM FM LO

الاسترخاء | الأمامي | المقاعد | **تدليك** | خلفي | الاسترخاء

الاسترخاء

أسفل الظهر

تمديد

تمديد أسفل الظهر

شديد

عالي

متوسط

منخفض

Off

السائق

الراكب

عالي

متوسط

منخفض

Off

الاسترخاء

أسفل الظهر

تمديد

تمديد أسفل الظهر

شديد



NW
A



Comfort



TUNE /
SCROLL

LO | ١٤:٠٠ | HITFM FM LO

الأمامي المقاعد تدليك **خلفي**

٥٢٢ ٥٢٢

قفل الخلفي

المزامنة مع السائق Off < 1 2 3 4 5 6 7 > آلي

ZONE

ZONE

VOL

TUNE/SCROLL

Comfort

LO



١٤:٠٦

HITFM FM



LO

ديناميكيات
المركبة

زاوية التوجيه:
0°

ملحقات
المقاييس

حالة النقل:
غير مغلق

انحدار و
التفاف

Selec-Terrain

قفل المحور
الخلفي:
غير مغلق

نظام التعليق

4WD
HIGH

55°21'60" E

25°10'07" N

ارتفاع -26 m

AUTO

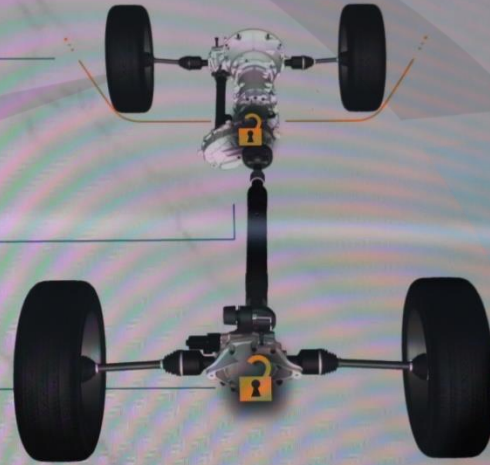

المركبة



NW
A



VOL



TUNE/
SCROLL





Тел.



АВТОМ.

Система



Navigation arrows, MAX, REAR, OFF, AUTO, A/C, Car icon, Navigation arrows

LO Front Seats Massage Rear Screen Off LO

Front Defrost

Sync Off 1 2 3 4 5 6 7 Max A/C

Navigation arrows, MUTE, AUTO HOLD ON, OFF, OFF, P ON, OFF, TOW/HAUL ON, Navigation arrows



MAX

REAR



AUTO

A/C



Front	Seats	Massage	Rear	Screen Off
<input type="button" value="-"/> Lumbar Up/Down <input type="button" value="+"/>	<p>Driver</p>	<p>Passenger</p>	<input type="button" value="-"/> Lumbar Up/Down <input type="button" value="+"/>	<input type="button" value="-"/> Lumbar Up/Down <input type="button" value="+"/>
<input type="button" value="-"/> Lumbar In/Out <input type="button" value="+"/>			<input type="button" value="-"/> Lumbar In/Out <input type="button" value="+"/>	<input type="button" value="-"/> Lumbar In/Out <input type="button" value="+"/>
<input type="button" value="-"/> Back Bolster <input type="button" value="+"/>			<input type="button" value="-"/> Back Bolster <input type="button" value="+"/>	<input type="button" value="-"/> Back Bolster <input type="button" value="+"/>
<input type="button" value="-"/> Thigh Bolster <input type="button" value="+"/>			<input type="button" value="-"/> Thigh Bolster <input type="button" value="+"/>	<input type="button" value="-"/> Thigh Bolster <input type="button" value="+"/>



MUTE



AUTO HOLD ON



PC ON



TOW HAUL ON





AUTO

A/C



Front Seats Massage Rear Screen Off

Waterfall	High	<p>Driver</p>	<p>Passenger</p>	High	Waterfall
Lower Back	Med			Med	Lower Back
Extend	Low			Low	Extend
Low Extend	Off			Off	Low Extend
Rock Climb					Rock Climb



MUTE



AUTO HOLD ON



P ON



TOW/HAUL ON



P

Home



Controls

Vehicle cameras

Fam Cam

Rear View

Check entire surrounding

Top View

Rear View

Surround View

Car icons: Red car, Car with downward arrow, Car with upward arrow, Car with lighthouse, Car with camera icon

AND WAGON

Home

Controls

Audio 

 Bluetooth

 FM

 AM

More...

Video 

 USB 1

 USB 2

More...

HDMI 

HDMI
HIGH DEFINITION MULTIMEDIA INTERFACE

Connect HDMI cable

Home



Controls

Navigation



Search



Favourites

Recent

Devices



0 devices connected



Pair new device



Manage Bluetooth headphones

Cameras

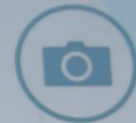

View vehicle
Camera apps



W A G O

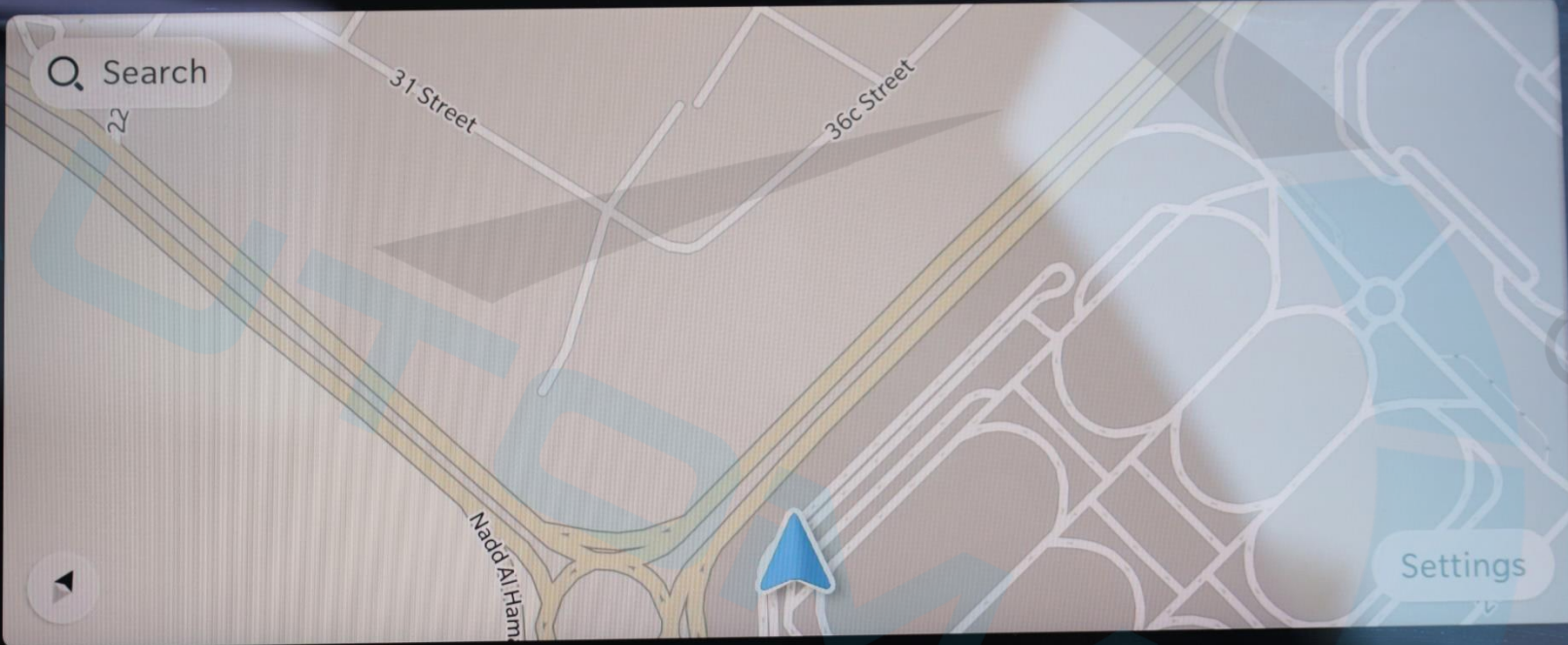

Home

Controls

Search

Settings

31 Street

36c Street

Nadd Al Ham

C R A N D W A G O N



Sync

Off

1

2

3

4

5



6

7

Max A/C



MUTE



OFF

AUTO
HOLD
ON



OFF



OFF



ON

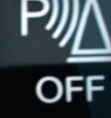

OFF

TOW/
HAUL
ON



P R N D

ROCK
SAND/MUD
SNOW
AUTO
SPORT



Sync Off 1 2 3 4 5 6 7 Max A/C

MAP AUTO OFF AUTO HOLD ON L4 OFF TRIP OFF PWR ON PWR OFF TOW HACE ON

P R N D

ROCK
SAND/MUD
SNOW
AUTO
SPORT

←
|
|
|
|
→

4WD
LOW

4x4

4N



22.0°

Rear Comfort

Screen Off

22.0°

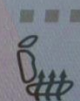
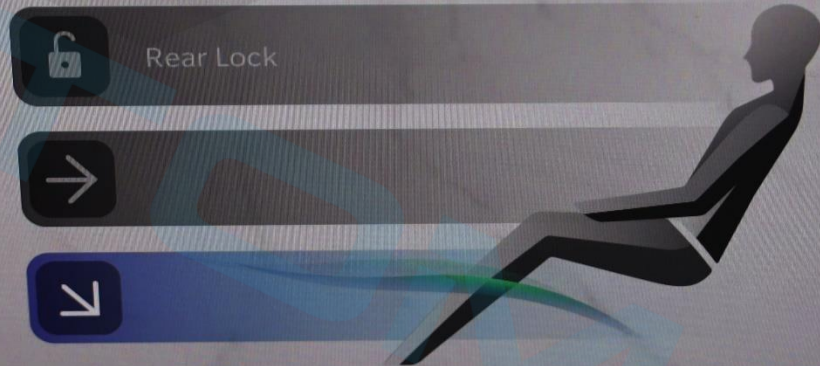
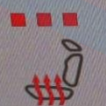

Sync

Off

1

2

3

4



5

6

7

Auto

230 V AC
150 W



12V DC















OFF



ON



OPEN



CLOSE

TILT



DOWN

OPEN



CLOSE



START
ENGINE
STOP

RUN

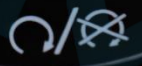





12V DC





AUTO

P

R

D

P

PULL ON





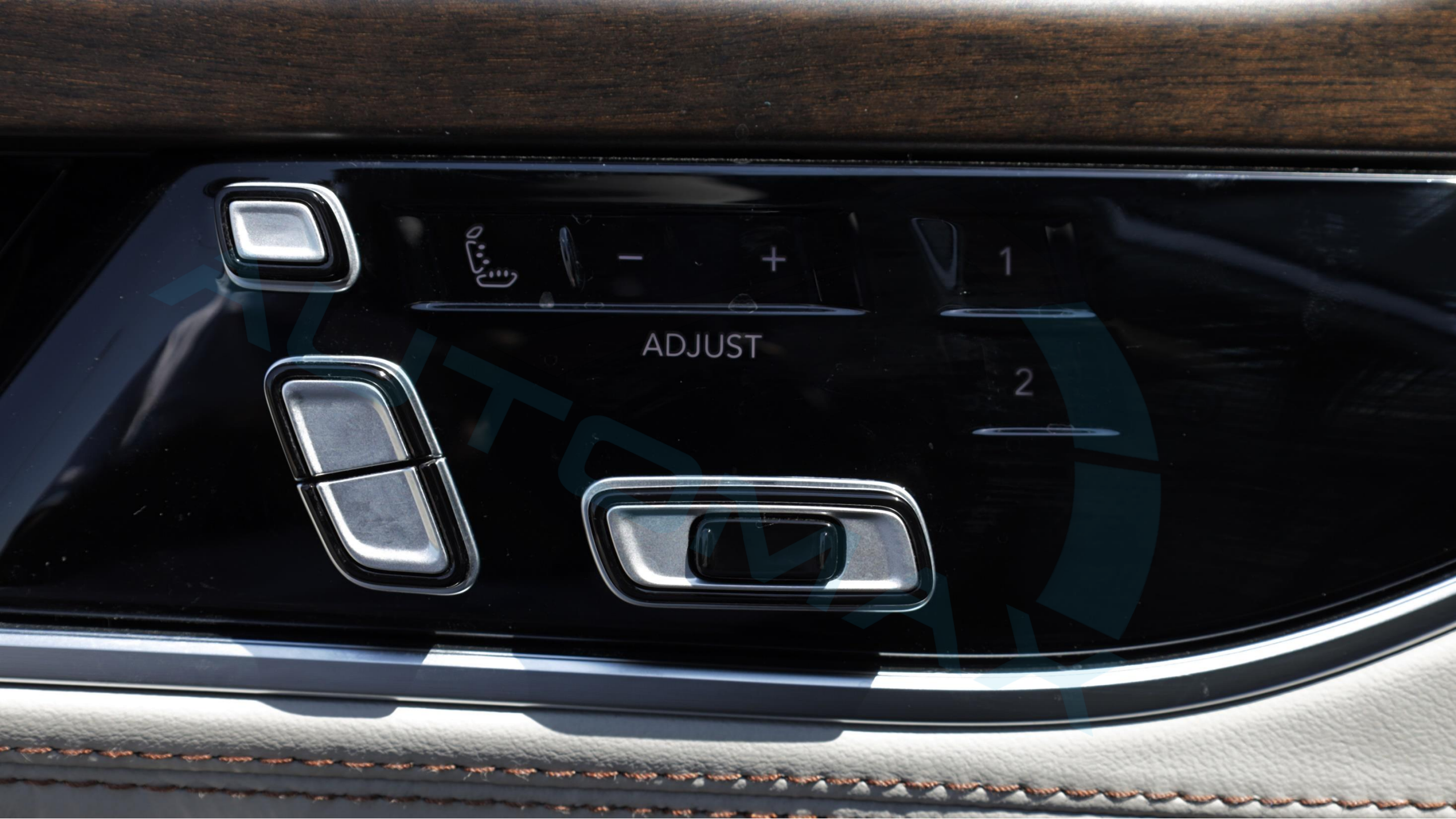

ADJUST

1

2



Infosh









P:810 SEQ:437220
P5541726 68400498AA



GRAND WAGONEER

ASTONE





TIRE COMPRESSOR



PULL





GRAND WAGONEER



GRAND





لمشاهدة صورة السيارة بزاوية 360 درجة إضغط على الصورة أعلاه

Для просмотра автомобиля в формате 360°, пожалуйста, нажмите на фото выше.

To view the 360° degree please press on the picture above

2023 JEEP GRAND WAGONEER SERIES II 16 3.0L TT 4X4 GCC 0Km

Бренд: Jeep

Brand: Jeep

الماركة: جيب

Категория: GRAND WAGONEER

Category: GRAND WAGONEER

الفئة: GRAND WAGONEER

Модель: SERIES II LUXURY

Model: SERIES II LUXURY

الموديل: SERIES II LUXURY

Год: 2023

Year: 2023

السنة: 2023

Километров: 0 Km

Kilometers: 0 Km

كيلومترات: 0 كم

Двери: 4 Doors

Doors: 4 Doors

عدد الأبواب: 4 أبواب

Цвет: Черный

Color: Diamond Black / Sea Salt

اللون: أسود

Цилиндр: 6

Cylinder: 6 Cylinders

عدد الأسطوانات: 6 أسطوانات

Лошадиные силы: 510 HP

Horsepower: 510 HP

عدد الأحصنة: 510 حصان

Трансмиссия: Автоматическая

Transmission: Automatic

نوع النقل: نقل أوتوماتيكي

Топливо: Бензин

Fuel: Gasoline

نوع الوقود: بنزين

4X4

4X4

4X4

GCC

المواصفات خليجية

2023 JEEP GRAND WAGONEER SERIES II 16 3.0L TT 4X4 GCC 0Km

LEATHER TRIMMED BUCKET SEATS
SEA SALT/BLACK
MIDDLE EAST EQUIPMENT GROUP
OFF ROAD GROUP II
FLEXIBLE SEATING GROUP
AUX BATTERY
40/20/40 2ND ROW BENCH PWR TIP/SLIDE
REMOVABLE ASH TRAY
8 PASSENGER SEATING
8-SPD AUTO 8HP75 TRANS (BUY-US)
3.0L 16 HURRICANE HO TWIN TURBO ESS
AUTO DIM EXTERIOR DRIVER MIRROR
CIGAR LIGHTER
GPS NAVIGATION
GPS ANTENNA INPUT
ACTIVE NOISE CONTROL SYSTEM
EXT. MIRRORS W/SUPPLEMENTAL SIGNALS
EXTERIOR MIRRORS W/ARABIC LETTERING
EXTERIOR MIRRORS W/MEMORY
AUTO ADJUST IN REVERSE EXT MIRRORS

HEATED EXTERIOR MIRRORS
EXTERIOR MIRRORS APPROACH LAMPS
BLACK ROOF
QUADRA DRIVE II BADGE
U.S. EMISSIONS W/OBD I
INTEGRATED TIRE COMPRESSOR KIT
DIAMOND BLACK CRYSTAL P/C
ALL RADIO EQUIPPED VEHICLES
12.0" TOUCHSCREEN DISPLAY
FRONT PASSENGER INTERACTIVE DISPLAY
2ND ROW DUAL CHG-ONLY USB PORTS
DIGITAL AUDIO BROADCASTING
ALL R1 HIGH RADIOS
BRIDGESTONE BRAND TIRES
ALL ALUMINUM WHEELS
FUEL TANK SKID PLATE SHIELD
TRANSFER CASE SKID PLATE SHIELD
FRONT AXLE SKID PLATE
STOP-START DUAL BATTERY SYSTEM
10 ADDITIONAL GALLONS OF GAS

2023 JEEP GRAND WAGONEER SERIES II 16 3.0L TT 4X4 GCS OKm

Quadra Drive II

INTEGRATED TIRE COMPRESSOR KIT

ADJUSTABLE ROOF RAIL CROSSBARS

8 местный

Зимний Пакет

Gear Limit

Вентиляция Сидений

Подогрев Сидений

Сиденья с функцией массажа

Рулевое Колесо с Подогревом

Регулируемые Сиденья с Памятью Позций

Дистанционный Запуск Двигателя

Система Мониторинга Слепых Зон

Бесключевой Доступ

Регулировка Режимов Вождения

Подрулевые Лепестки

Пневмоподвеска

Дистанционное управление пневмоподвеской

Адаптивный Круиз-контроль

ДИСПЛЕЙ ДЛЯ ПАССАЖИРА

Камера Наблюдения Внутри Салона

Холодильник

Контурная Подсветка Салона

Система Экстренного Торможения

Контроль Полосы Движения

Проекция на лобовое стекло

MCINTOSH Премиальная Мультимедийная Система С 19-МИ ДИНАМИКАМИ

Камера 360 Градусов

Панорамная Крыша

Беспроводная Зарядка

Система Помощи При Спуске с Горы

Датчик Давления в Шинах

Розетка

Задние Шторки

Система «Старт-Стоп»

Выдвижная Боковая Подножка

Автопарковка

R 20"

Apple Carplay + Android Auto

2023 JEEP GRAND WAGONEER SERIES II 16 3.0L TT 4X4 GCC 0Km

* الأداء:

ناقل حركة أوتوماتيكي ب 8 سرعات

عدد الأسطوانات: 6 أسطوانات

سعة المحرك: 3.0 توين توربو

العزم: 677 نيوتن.متر

عدد الأحصنة: 510 حصان

دفع رباعي 4X4

* المواصفات الإضافية:

Quadra Drive II

Gear Limit

INTEGRATED TIRE COMPRESSOR KIT

ADJUSTABLE ROOF RAIL CROSSBARS

8 مراتب

كاميرا بزاوية 360 درجة

شاشة بروجكتر أمامي

شاشة إضافية للمرافق

ثلاجة أمامية

عداد ديجيتال

مثبت السرعة التكميلي

نظام الهيدروليك لرفع و خفض المركبة مع خاصية التحكم عن بعد

نظام صوتي متقدم من MCINTOSH مع 19 سماعة

خاصية التبريد والتدفئة للمراتب

خاصية المساج للمراتب

فتحة سقف بانوراما مزدوجة

خاصية تثبيت المسار

كاميرا داخلية بزاوية 180 درجة

نظام الملاحة وتحديد المواقع

2023 JEEP GRAND WAGONEER SERIES II 16 3.0L TT 4X4 GCC 0Km

خاصية الكشف عن النقطة العمياء

أوتو بارك

التشغيل عن بعد

دخول بصمة

خاصية تدفئة المقود

خاصية المساعدة في نزول المنحدرات

نظام البطارية المزدوجة للبدء والتوقف

نظام مكابح متقدم مع الفرامل التلقائية

وضعية قيادة متعددة

مراتب كهربائية متعددة الوضعية مع خاصية الذاكرة

وحدة تكييف خلفية منفصلة

ابل كاربلاي لاسلكي

اندرويد أوتو لاسلكي

إنارة داخلية محيطيه

دبّة كهرباء مع حساس قدم

مخارج طاقة كهربائية متعددة

شاحن هاتف لاسلكي

ستائر خلفية

عتبات جانبية كهربائية

جنوط مقاس 20 بوصة

AUTOMAX®

The Boutique Of Muscle Cars, Truck Fanatics & German Automotive Experts.



تتكلم اللغة العربية

WE SPEAK ENGLISH

ON PARLE LE FRANCAIS

Nosotros hablamos español

мы говорим по-русски

biz o'zbek tilida

gaplashamiz

हम हिंदी बोलते हैं



automaxgroup.me



automax group



automax.dxb



Automax_LLC



+971 50 602 7200



automax.dxb



automax.dxb



automax.dxb



automax_dxb



automax group L.L.C

New Auto Market - Dubai - United Arab Emirates

 **Directions**