



AUTOMAX  
AUTOMAX SA - CHANGHAI

GRAND WAGONEER





GRAND WAGONEER

AUTOMAX  
AUTOMAX ج.م.ش. ٤٣ ٩٤ ٥٥٥٥٤٦٧٧٧



GRAND WAGONEER

AUTOMAR

GRAND WAGONEER



GRAND WAGONEER





GRAND WAGONEER

GRAND WAGONEER

AUTOMAT



GRAND WAGONEER







GRAND WAGONEER

AIRBAG

SET+  
CANC RES  
SET-

GEAR  
LIMIT

Top View

START  
ENGINE  
STOP



SET+



CANC



RES



SET-



- GEAR  
LIMIT +



0

km/h

ALU-TOPMAX

1. Driver info

P

37°C

NW

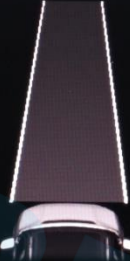

OFF RD

Driver Assist  
Press Ok to Zoom In



1. Driver info



Hold OK for Digital

0

km/h  
OK for MPH

Speedometer  
80 km

P



ON OFF

OFF

OFF

NW

5. Off Road



AUTO

Automatic Full  
Time 4WD  
Adapts to  
Road Conditions



P  
OFF RD 2  
Maximum  
Ground Clearance

37°C



Terrain Status  
80 km





# 4. Navigation

NW



Nadd Al Hamar Road

80 km

P

23 Street

37°C



OFF RD



1000  
1000

Check entire surroundings



Top View

Rear View

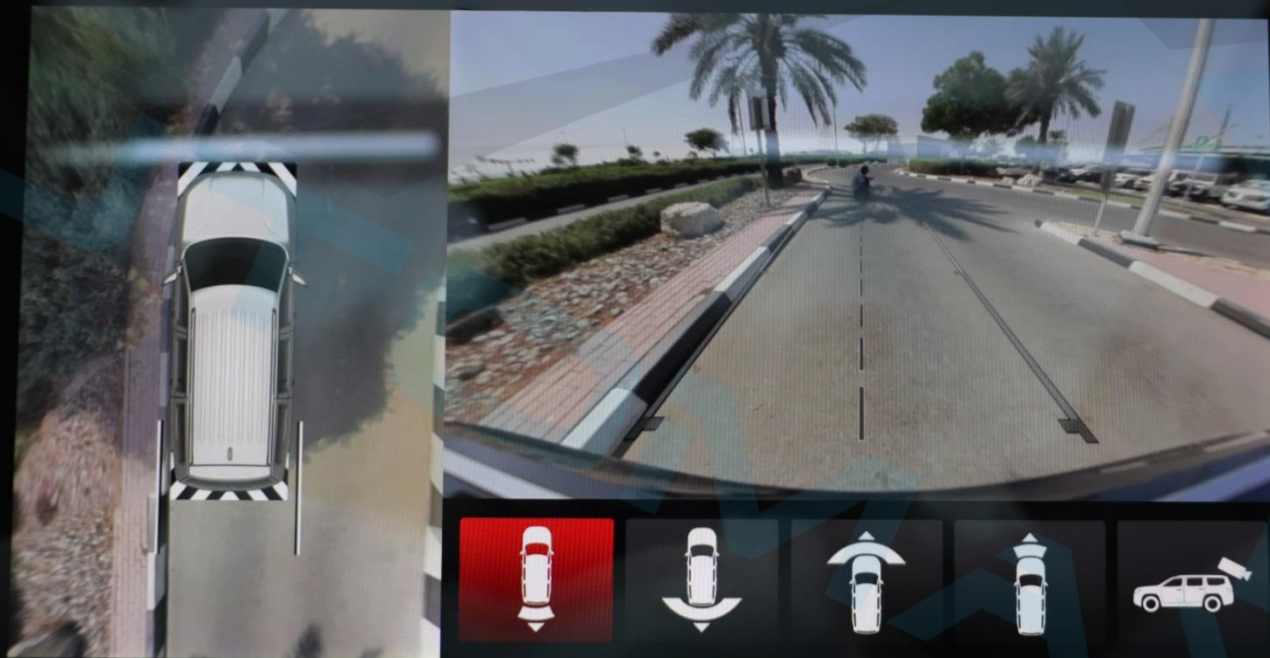

Select a seat to change zoom view



Volume control knob with VOL icon and up/down arrows.

TUNE/SCROLL knob with up/down arrows and a power button icon.

Climate control panel with buttons for MAX, REAR, OFF, AUTO, A/C, and a car icon.

Map interface with search bar and street names:

- Search
- 18a Street
- 7 Street
- 23 Street
- 25c Street
- 27c Street
- 36c Street

Radio player interface:

- HITFM
- HITFM ARN NETWORK - 044...
- All presets
- Play/Pause buttons

Phone pairing interface:

- Phone
- Select 'Add Device' to start the pairing process.
- Add device
- Device Manager

Edit pages

VOL [Volume knob]

TUNE SCROLL [Tune knob]



### Pitch



1°

### Roll

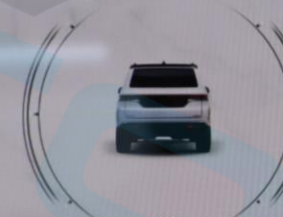

0°

### Suspension

OFF RD 2



Edit pages

Home



NW



vol

TUNE SCROLL

LO [Icons] 1:34 FM HITFM [Icons] LO

Front Seats Massage Rear

Front defrost

Heat

Vent

Heat

Vent

Max A/C A/C Max Rear

Sync Off < 1 2 3 4 5 6 7 > Auto [Car Icon]



[Home] [Music] [Comfort] [NW A] [Phone] [Car] [Grid] [TUNE/SCROLL]



Wednesday, 2 October 2024 [Settings]

shortcuts  
Icons to drag to status bar above

- [Icon]
- [Icon]
- [Icon]
- Sync

37°  
OUT  
Temperature

[Icon]  
Profiles

[Icon]  
Notifications

[Icon]  
Fam Cam

[Icon]  
Device Manager



LO [Icons] 1:34 [FM] HITFM [Icons] LO

Front **Seats** Massage Rear

- Lumbar Up/Down +		- Lumbar Up/Down +
- Lumbar In/Out +		- Lumbar In/Out +
- Back Bolster +		- Back Bolster +
- Thigh Bolster +		- Thigh Bolster +

Driver Psgr.

Physical touch controls on the left and right sides of the screen, including volume knobs, power buttons, and touch-sensitive sliders for seat adjustments.

START ENGINE STOP

Bottom navigation bar with icons for Home, Music, Comfort (active), Navigation (NW), Phone, Vehicle, and App Grid. Includes physical volume and tune/scroll knobs.



LO [Icons] 1:35 FM HITFM [Icons] LO

Front Seats **Massage** Rear

Waterfall

Lower back **High** High

Med Med

Extend Extend

Low Low

Low extend Low extend

Off Off

Rock climb Rock climb

Driver Psgr.

VOL [Knob] [Home] [Music] **Comfort** [NW] [Phone] [Car] [Grid] [TUNE/SCROLL] [Knob]

[Icons] MAX REAR [Icons] OFF AUTO A/C [Icons]

22.0° Front 22.0°

LO 1:35 FM HITFM LO

22° Front Seats Massage Rear 22°

Lock rear

SYNC to driver Off 1 2 3 4 5 6 7 Auto

VOL TUNE SCROLL

Home Music Comfort NW A Phone Car Grid

MAX REAR OFF AUTO A/C

LO | 1:36 HITFM | LO

Off road | **Controls** | Settings

Mirror Dimmer	2nd row headrest fold	3rd row headrest fold
Pass screen Screen off	Passenger screen power off	Power Side Step
Surround camera	FamCam	Rear View camera

MAX REAR OFF AUTO A/C

LO [Icons] 1:36 FM HITFM [Icons] LO

**Vehicle Dynamics**

Steering Angle: 0°

Transfer Case: Unlocked

Rear Axle Locker: Unlocked

**Suspension** 4WD HIGH 55°21'60" E 25°10'07" N Altitude -26 m AUTO

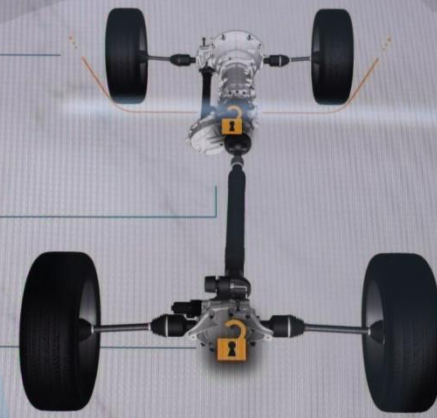

VOL

Home Music Phone NW A Vehicle [Grid]

TUNE/SCROLL

[MAX] [REAR] [Icons] [AUTO] [A/C]

Vehicle Dynamics

Accessory Gauges

Pitch & Roll

Selec-Terrain

Suspension

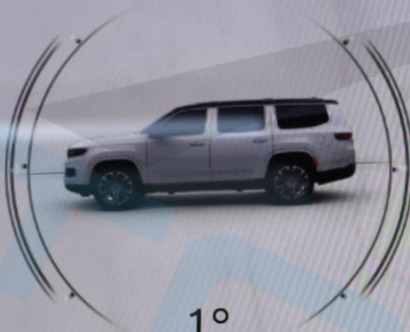

1°

Pitch

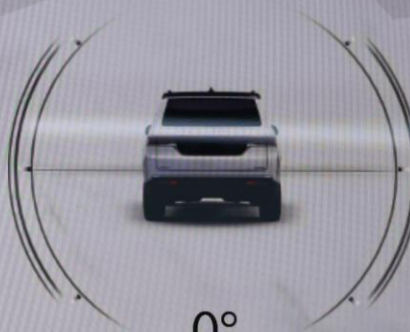

0°

Roll

4WD HIGH

55°21'60" E

25°10'07" N

Altitude -26 m

AUTO



NW



TUNE/SCROLL

Vehicle

LO 1:37 FM HITFM LO

Vehicle Dynamics

Accessory Gauges

Pitch & Roll

Selec-Terrain

Suspension



4WD HIGH 55°21'60" E 25°10'07" N Altitude -26 m AUTO



NW  
A



Vehicle



TUNE/SCROLL



MAX

REAR



AUTO

A/C

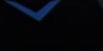

- Automatic Emergency Braking >
- Display Active Lane Management >
- Entertainment screens ParkSense ⓘ Only warning  Warning + braking assist
- My profile Front ParkSense Volume ⓘ Low  Med  High
- Safety & driving assistance Rear ParkSense Volume ⓘ Low  Med  High



LO [Icons] 13:38 FM HITFM [Icons] LO

Off road Controls Settings

Blind Spot Alert  Off  Lights  Lights + chime

Electric power steering default  Normal  Sport  Comfort

Power Side Step  Auto  Store

Hill Start Assist

Tire Fill Assist

VOL

[Volume Knob]

[Home] [Music] [Sport] [NW] [Phone] [Vehicle] [App Grid]

TUNE/SCROLL

[Tune/Scroll Knob]

START ENGINE STOP

[Start Button]



LO [Icons] 13:38 FM HITFM [Icons] LO

Favourites All

Media

Comfort

Nav

Phone

AM	AM radio	Audio settings	Auxiliary cable	Bluetooth
DAB	DAB	Device Manager	FM radio	Media

ZONE

[Icons]

ZONE

[Icons]

VOL

[Knob]

TUNE/SCROLL

[Knob]

[Home] [Music] [Phone] [NW] [Car] [Apps]

LO [Icons] 13:38 FM HITFM [Icons] LO

Favourites All

Media

Comfort

Nav

Phone

DAB

Device Manager

FM radio

Media

USB 1

USB 2



Apps

Favourites

All

Media

Comfort

Nav

Phone



Comfort



Driver Heat



Driver Vent



Heated wheel



Massage seats



Psgr heat



Psgr vent



NW  
A



Apps



AUTO

A/C



LO [Icons] 13:38 FM HITFM [Icons] LO

Favourites All

Media

Comfort

Nav

Phone

Android Auto

Device Manager

Phone

VOL

TUNE/SCROLL

START ENGINE STOP

Home Music Navigation Phone Vehicle Apps

LO [Icons] 13:39 FM HITFM [Icons] LO

Favourites All

- Phone
- Vehicle**
- System
- Other

Ambient Colour	Audio settings	Controls	FamCam
Mirror dimmer	Off Road Pages	Rear view camera	Select. tyre fill alert





Home Music Navigation (NW) Phone Vehicle Apps

MAX REAR [Icons] AUTO A/C [Icons]

Favourites All

- Phone
- Vehicle**
- System
- Other

  
Settings

  
Surround camera

  
Vehicle

  
2nd row headrest...

  
3rd row headrest...

Favourites All

Phone

Vehicle

System

Other



Driver profiles



Software updates



Stored Notificati...



NW  
A



Apps

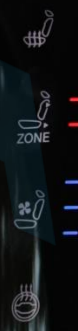

LO [Icons] 13:39 FM HITFM [Icons] LO

Favourites All

- Phone
- Vehicle
- System
- Other



McIntosh



Relax



Tutorials

- Home
- Music
- Activity
- NW A
- Phone
- Car
- Apps

- PHONE
- PHONE
- PHONE

- PHONE
- PHONE
- PHONE
- PHONE



- MAX
- REAR
- OFF
- AUTO
- A/C



LO | | | 13:41 FM HITFM | LO

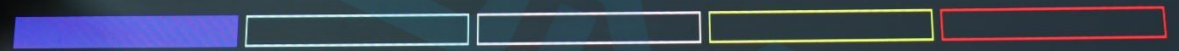
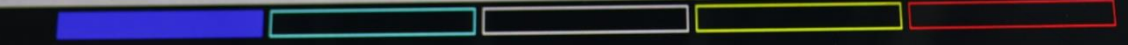

VOL

TUNE/SCROLL



Показать весь доступный диапазон



Вид сверху

Вид сзади



VOL

TUNE SCROLL



AUTO

A/C



22.0°

Front

Seats

Massage

Rear

Screen Off

22.0°

Выбрать сиденье, чтобы изменить масштабированный вид



Управление климатом

↑&G

#  
ZONE  
\*  
⏻

↕  
TUNE/  
SCROLL

MAX REAR OFF AUTO A/C

Низ. | | | 13:48 | FM HITFM | Низ.

Поиск Street

22 Street 25c Street 23 Street 13b Street  
31 Street 27c Street 36c Street Nadd Al Hamar Road

3D

40

VOL

C3  
▲  
Nav

TUNE SCROL

START ENGINE STOP

### Наклон



1°

### Крен

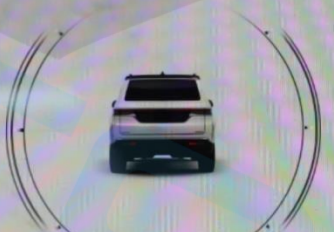

0°

### Подвески

OFF RD 2



Редактировать страницы

Главная



C3  
A



VOL

TUNE  
SCROLL

Передн. Сиденья **Массаж** Задний

Расслабл.

Низ спины

Растягив.

Низ растягив.

**Энергичный**

**Гром.**

Сред.

Низ.

Off



Водит.



Пассаж.

**Гром.**

Сред.

Низ.

Off



Расслабл.

Низ спины

Растягив.

Низ растягив.

**Энергичный**



C3



Низ. 13:47 FM HITFM Низ.

Передн. Сиденья Массаж Задний

Пер. обдув

Об. Вен

Макс. А/С A/C Максим. Задний

Синхр. Off 1 2 3 4 5 6 7 Авт.

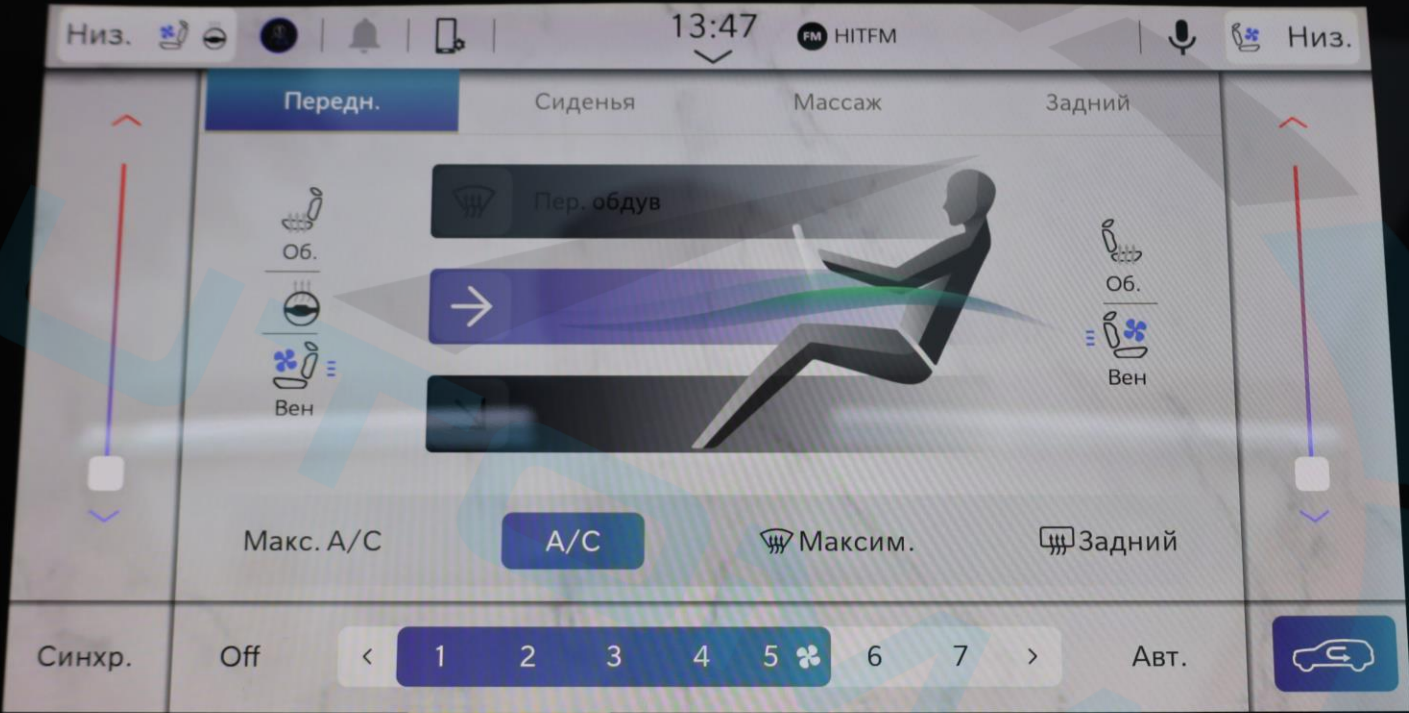

**Динамика  
автомобиля**

Угол поворота  
рулевого колеса:  
0°

**Вспомог.  
приборы**

Раздаточная  
коробка:  
Разблокирована

**Попер.  
перемещения**

**Selec-Terrain**

Блокиратор  
заднего моста:  
Разблокирована

**Подвески**

**4WD HIGH** 55°21'60" В 25°10'07" С Высота -26 м AUTO

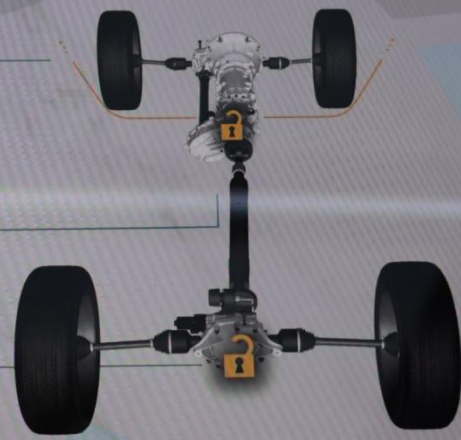

VOL  
↑ ↓



C3  
A



АВТОМ.



TUNE  
SCROLL



تحقق من البيئة المحيطة بأكملها



الرؤية العلوية

الرؤية الخلفية

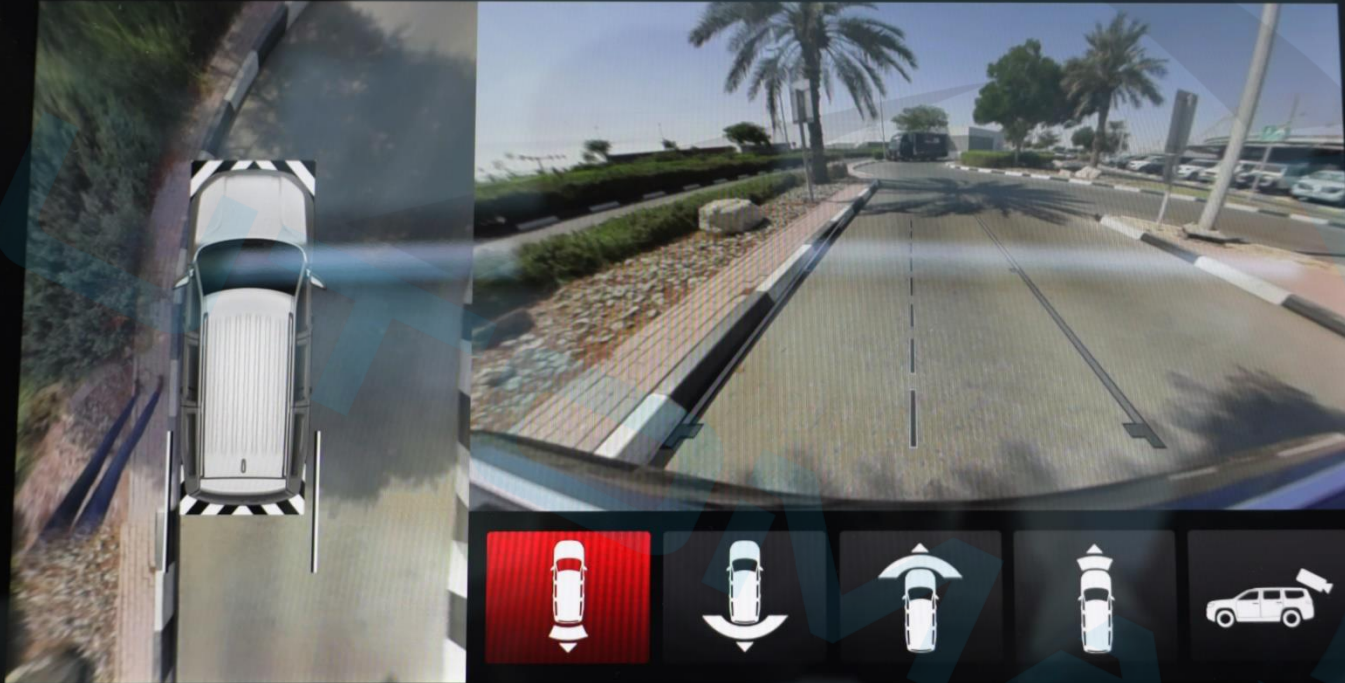

اختر مقعد لتغيير تكبير العرض



TUNE/SCROLL

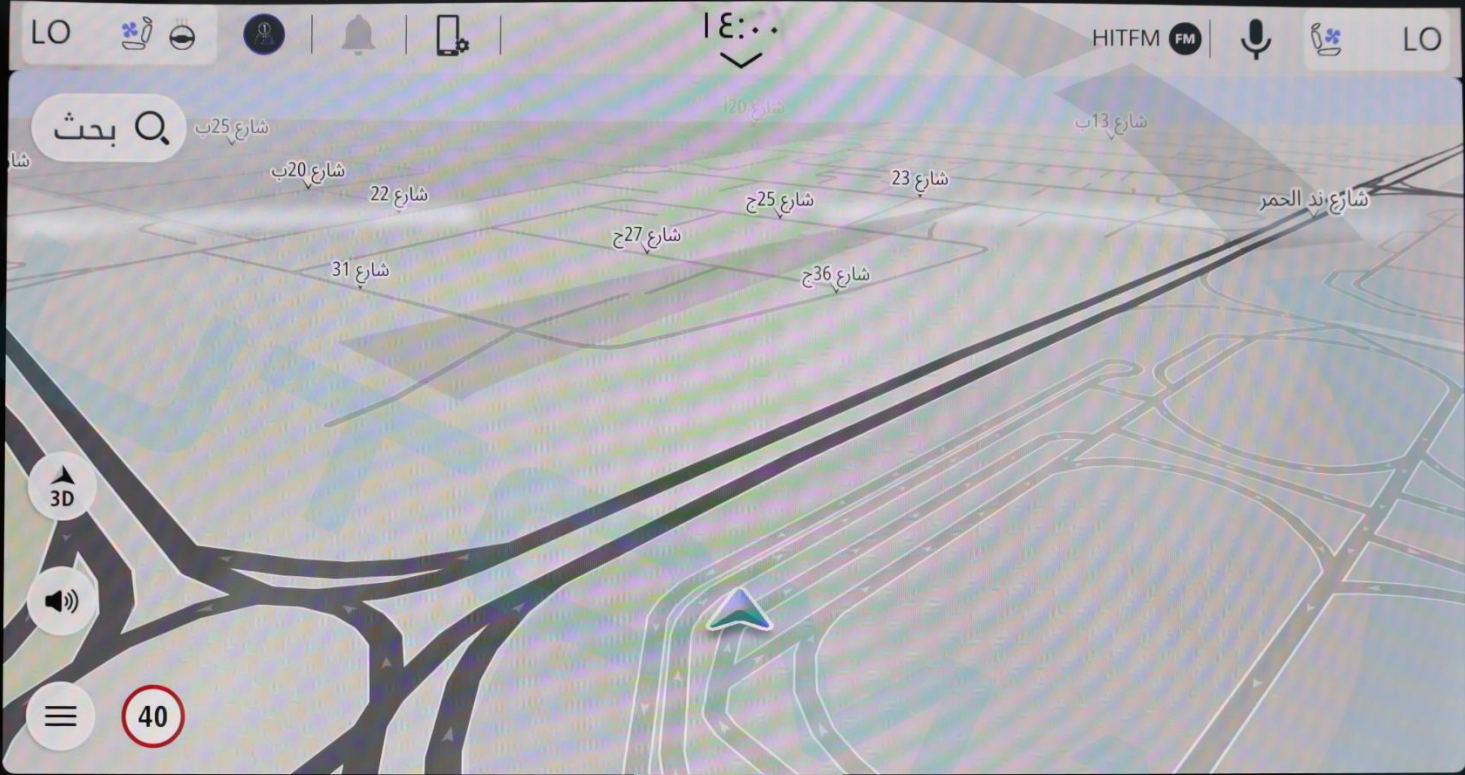

NW



Nav

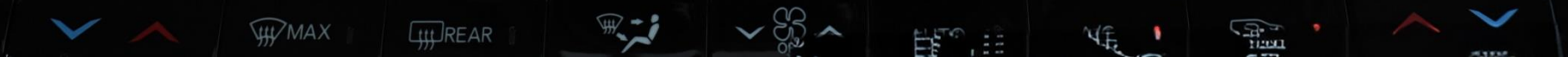

### نظام التعليق

OFF RD 2



### انحدار

1°

### التفاف

0°



تحرير الصفحات

LO [Icons] 13:09 HITFM FM [Icons] LO

الأمامي المقاعد تدليك خلفي

إزالة الصقيع الأمامي

تسخين تبريد

تسخين تبريد

أقصى تكييف الهواء حد أقصى خلفي

مزامنة Off 1 2 3 4 5 6 7 ألي

ZONE

ZONE

VOL

TUNE/SCROLL



NW



Comfort



LO 14:00 HITFM FM LO

الاسترخاء المقاعد تدليك خلفي الاسترخاء

الاسترخاء

أسفل الظهر **عالي**

تمديد متوسط

تمديد أسفل الظهر منخفض

شديد Off

السائق

الراكب

عالي

متوسط

منخفض

Off

الاسترخاء

أسفل الظهر **عالي**

تمديد متوسط

تمديد أسفل الظهر منخفض

شديد Off



NW  
A



Comfort



TUNE/  
SCROLL

LO | ١٤:٠٠ | HITFM FM LO

الأمامي المقاعد تدليك **خلفي**

٥٢٢ ٥٢٢

قفل الخلفي

المزامنة مع السائق Off 1 2 3 4 5 6 7 آلي

ZONE

ZONE

VOL

TUNE/SCROLL

Comfort

LO



١٤:٠٦

HITFM FM



LO

ديناميكيات  
المركبة

زاوية التوجيه:  
0°

ملحقات  
المقاييس

حالة النقل:  
غير مغلق

انحدار و  
التفاف

Selec-Terrain

قفل المحور  
الخلفي:  
غير مغلق

نظام التعليق

4WD  
HIGH

55°21'60" E

25°10'07" N

ارتفاع -26 m

AUTO

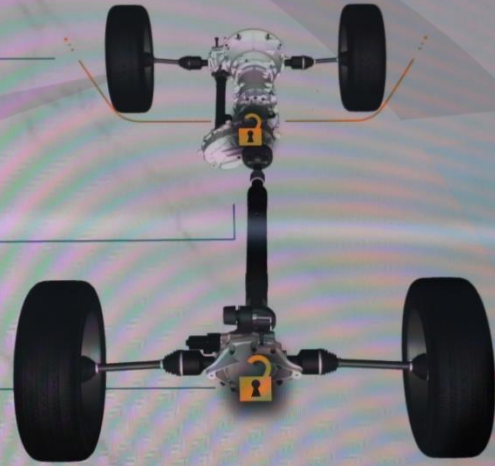

المركبة



NW  
A



VOL

TUNE/  
SCROLL





Тел.



АВТОМ.

Система



Navigation arrows, MAX, REAR, OFF, AUTO, A/C, Car icon, Navigation arrows

LO      Front      Seats      Massage      Rear      Screen Off      LO

Front Defrost

→

↘

Sync    Off    1    2    3    4    5    6    7    Max A/C

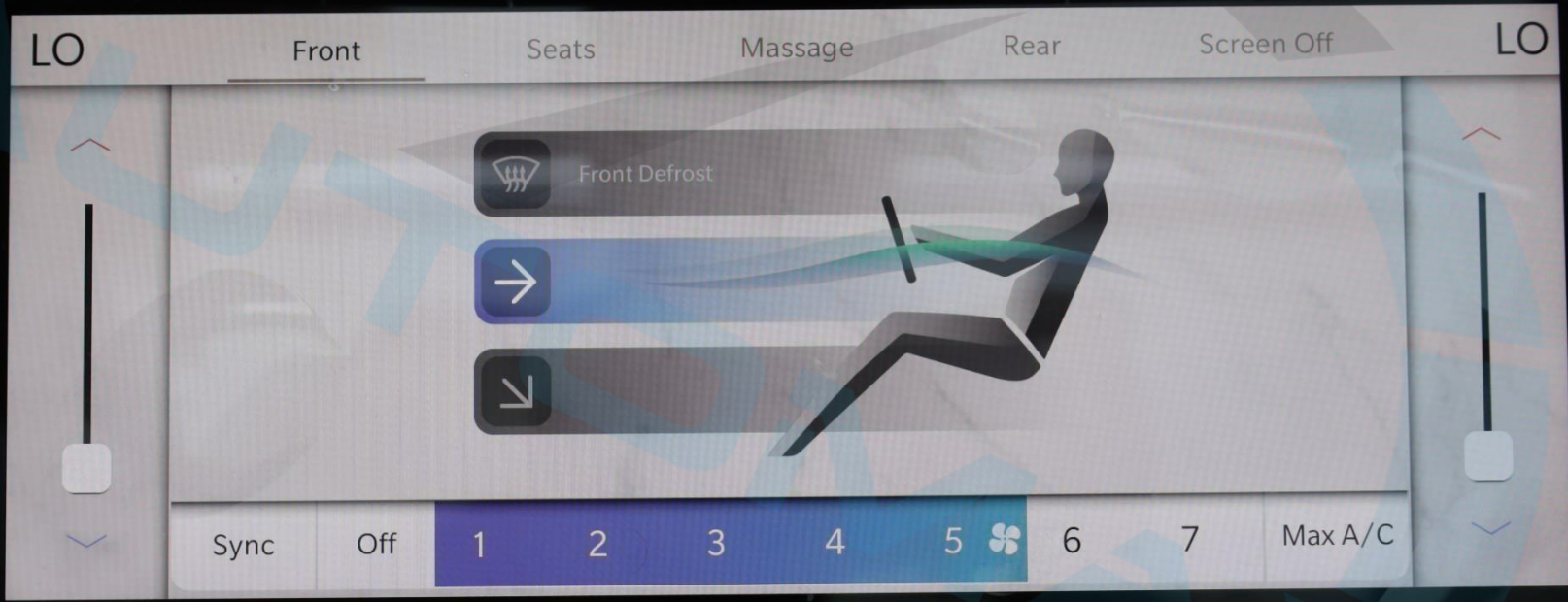

Navigation arrows, MUTE, AUTO HOLD ON/OFF, OFF, ON, OFF, TOW/HAUL ON, Navigation arrows



MAX

REAR



AUTO

A/C



Front Seats Massage Rear Screen Off

<input type="button" value="−"/> Lumbar Up/Down <input type="button" value="+"/>	 <p>Driver</p>	 <p>Passenger</p>	<input type="button" value="−"/> Lumbar Up/Down <input type="button" value="+"/>
<input type="button" value="−"/> Lumbar In/Out <input type="button" value="+"/>			<input type="button" value="−"/> Lumbar In/Out <input type="button" value="+"/>
<input checked="" type="button" value="−"/> Back Bolster <input checked="" type="button" value="+"/>			<input type="button" value="−"/> Back Bolster <input type="button" value="+"/>
<input type="button" value="−"/> Thigh Bolster <input type="button" value="+"/>			<input type="button" value="−"/> Thigh Bolster <input type="button" value="+"/>



MUTE



AUTO HOLD ON



P ON

P OFF

TOW HAUL ON





AUTO

A/C



Front Seats Massage Rear Screen Off

Waterfall	High	<p>Driver</p>	<p>Passenger</p>	High	Waterfall
Lower Back	Med			Med	Lower Back
Extend	Low			Low	Extend
Low Extend	Off			Off	Low Extend
Rock Climb					Rock Climb



MUTE



AUTO HOLD ON



ON



OFF

TOW/HAUL ON



P

Home



Controls

Vehicle cameras

Fam Cam



Rear View

Check entire surrounding

Top View

Rear View

Surround View



AND WAGON

Home

Controls

Audio 

---

 Bluetooth

 FM

 AM

More...

Video 

---

 USB 1

 USB 2

More...

HDMI 

---

**HDMI**  
HIGH DEFINITION MULTIMEDIA INTERFACE

Connect HDMI cable

Home



Controls

### Navigation



Search



Favourites

Recent

### Devices



0 devices connected



Pair new device



Manage Bluetooth headphones

### Cameras

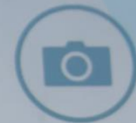

View vehicle  
Camera apps



W A G O

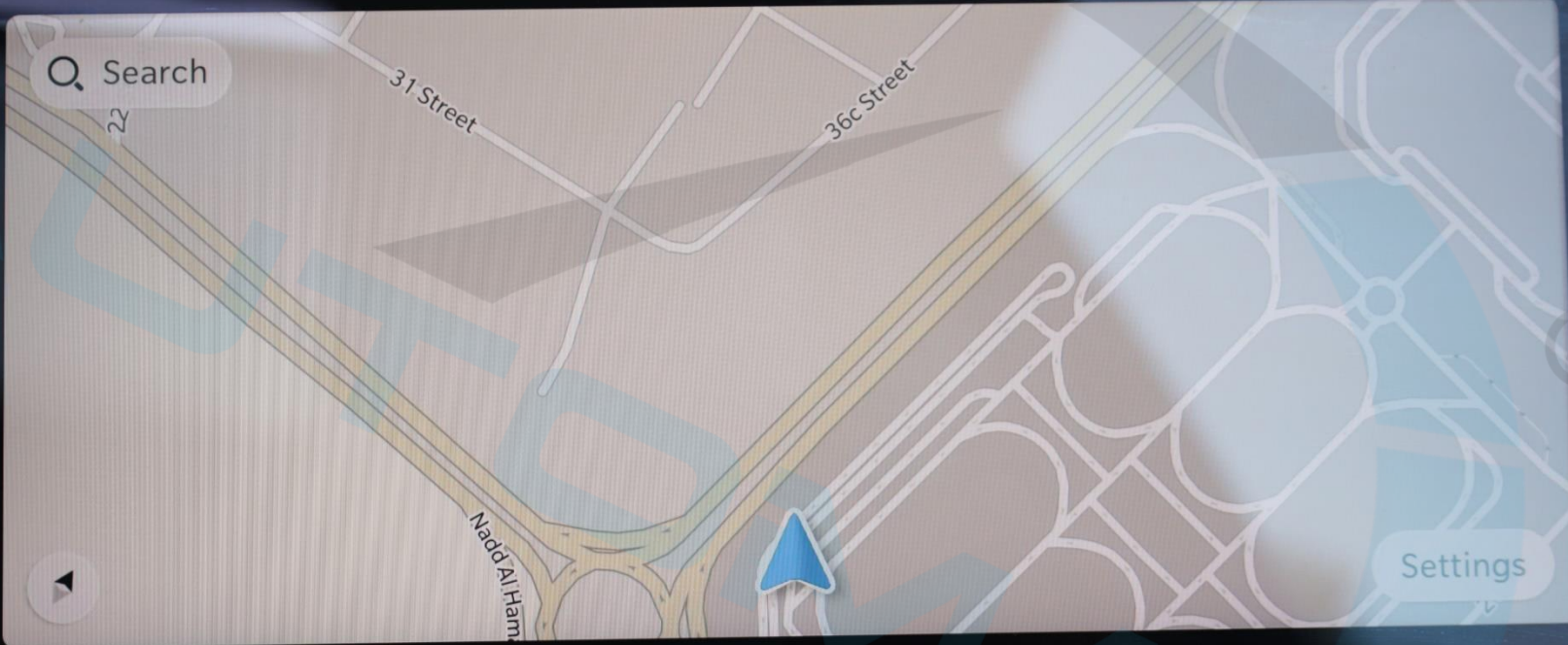

Home

Controls

Search

31 Street

36c Street

Nadd Al Ham

Settings

C R A N D W A G O N





Sync

Off

1

2

3

4

5



6

7

Max A/C



MUTE



OFF

AUTO  
HOLD  
ON



OFF



OFF



ON



OFF

TOW/  
HAUL  
ON



P R N D

ROCK  
SAND/MUD  
SNOW  
AUTO  
SPORT



Sync Off 1 2 3 4 5 6 7 Max A/C

MAP AUTO OFF AUTO HOLD ON L4 OFF TRIP ON OFF PWR HOLD ON TOW HACE ON

P R N D

ROCK  
SAND/MUD  
SNOW  
AUTO  
SPORT

←  
|  
|  
|  
|  
→

4WD  
LOW

4x4

4N



22.0°

Rear Comfort

Screen Off

22.0°

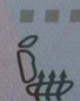
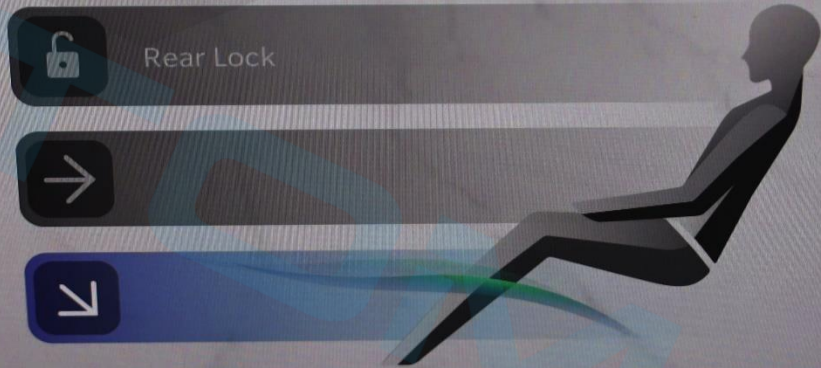
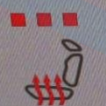

Sync

Off

1

2

3

4



5

6

7

Auto

230 V AC  
150 W

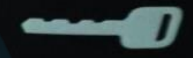

12V DC





















OFF

ON



OPEN



AUTO

CLOSE

TILT



DOWN

OPEN



AUTO

CLOSE



START  
ENGINE  
STOP

RUN

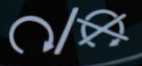







12V DC





AUTO

P

R

N

D

P

PULL ON





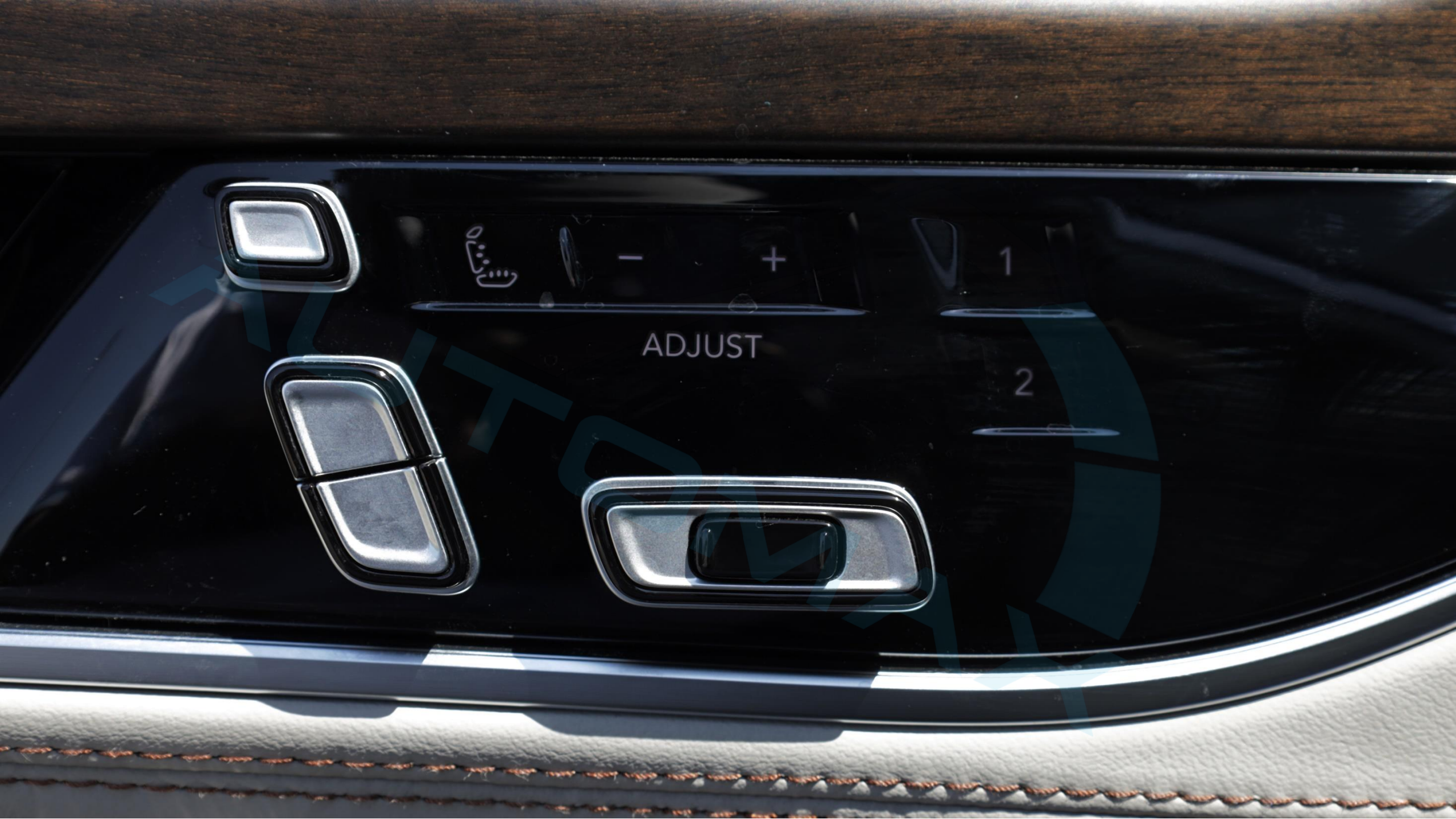

ADJUST

1

2



Infosh











P:810 SEQ:437220  
P5541726 68400498AA



GRAND WAGONEER

ASTONE







TIRE COMPRESSOR



PULL





GRAND WAGONEER



GRAND





لمشاهدة صورة السيارة بزاوية 360 درجة إضغط على الصورة أعلاه

Для просмотра автомобиля в формате 360°, пожалуйста, нажмите на фото выше.

To view the 360° degree please press on the picture above

# 2023 JEEP GRAND WAGONEER SERIES II 16 3.0L TT 4X4 GCC 0Km

Бренд: Jeep

Brand: Jeep

الماركة: جيب

Категория: GRAND WAGONEER

Category: GRAND WAGONEER

الفئة: GRAND WAGONEER

Модель: SERIES II LUXURY

Model: SERIES II LUXURY

الموديل: SERIES II LUXURY

Год: 2023

Year: 2023

السنة: 2023

Километров: 0 Km

Kilometers: 0 Km

كيلومترات: 0 كم

Двери: 4 Doors

Doors: 4 Doors

عدد الأبواب: 4 أبواب

Цвет: Черный

Color: Diamond Black / Sea Salt

اللون: أسود

Цилиндр: 6

Cylinder: 6 Cylinders

عدد الأسطوانات: 6 أسطوانات

Лошадиные силы: 510 HP

Horsepower: 510 HP

عدد الأحصنة: 510 حصان

Трансмиссия: Автоматическая

Transmission: Automatic

نوع النقل: نقل أوتوماتيكي

Топливо: Бензин

Fuel: Gasoline

نوع الوقود: بنزين

4X4

4X4

المواصفات خليجية  
4X4

# 2023 JEEP GRAND WAGONEER SERIES II 16 3.0L TT 4X4 GCC 0Km

LEATHER TRIMMED BUCKET SEATS  
SEA SALT/BLACK  
MIDDLE EAST EQUIPMENT GROUP  
OFF ROAD GROUP II  
FLEXIBLE SEATING GROUP  
AUX BATTERY  
40/20/40 2ND ROW BENCH PWR TIP/SLIDE  
REMOVABLE ASH TRAY  
8 PASSENGER SEATING  
8-SPD AUTO 8HP75 TRANS (BUY-US)  
3.0L 16 HURRICANE HO TWIN TURBO ESS  
AUTO DIM EXTERIOR DRIVER MIRROR  
CIGAR LIGHTER  
GPS NAVIGATION  
GPS ANTENNA INPUT  
ACTIVE NOISE CONTROL SYSTEM  
EXT. MIRRORS W/SUPPLEMENTAL SIGNALS  
EXTERIOR MIRRORS W/ARABIC LETTERING  
EXTERIOR MIRRORS W/MEMORY  
AUTO ADJUST IN REVERSE EXT MIRRORS

HEATED EXTERIOR MIRRORS  
EXTERIOR MIRRORS APPROACH LAMPS  
BLACK ROOF  
QUADRA DRIVE II BADGE  
U.S. EMISSIONS W/OBD I  
INTEGRATED TIRE COMPRESSOR KIT  
DIAMOND BLACK CRYSTAL P/C  
ALL RADIO EQUIPPED VEHICLES  
12.0" TOUCHSCREEN DISPLAY  
FRONT PASSENGER INTERACTIVE DISPLAY  
2ND ROW DUAL CHG-ONLY USB PORTS  
DIGITAL AUDIO BROADCASTING  
ALL R1 HIGH RADIOS  
BRIDGESTONE BRAND TIRES  
ALL ALUMINUM WHEELS  
FUEL TANK SKID PLATE SHIELD  
TRANSFER CASE SKID PLATE SHIELD  
FRONT AXLE SKID PLATE  
STOP-START DUAL BATTERY SYSTEM  
10 ADDITIONAL GALLONS OF GAS

# 2023 JEEP GRAND WAGONEER SERIES II 16 3.0L TT 4X4 GCS OKm

Quadra Drive II

INTEGRATED TIRE COMPRESSOR KIT

ADJUSTABLE ROOF RAIL CROSSBARS

8 местный

Зимний Пакет

Gear Limit

Вентиляция Сидений

Подогрев Сидений

Сиденья с функцией массажа

Рулевое Колесо с Подогревом

Регулируемые Сиденья с Памятью Позций

Дистанционный Запуск Двигателя

Система Мониторинга Слепых Зон

Бесключевой Доступ

Регулировка Режимов Вождения

Подрулевые Лепестки

Пневмоподвеска

Дистанционное управление пневмоподвеской

Адаптивный Круиз-контроль

ДИСПЛЕЙ ДЛЯ ПАССАЖИРА

Камера Наблюдения Внутри Салона

Холодильник

Контурная Подсветка Салона

Система Экстренного Торможения

Контроль Полосы Движения

Проекция на лобовое стекло

MCINTOSH Премиальная Мультимедийная Система С 19-МИ ДИНАМИКАМИ

Камера 360 Градусов

Панорамная Крыша

Беспроводная Зарядка

Система Помощи При Спуске с Горы

Датчик Давления в Шинах

Розетка

Задние Шторки

Система «Старт-Стоп»

Выдвижная Боковая Подножка

Автопарковка

R 20"

Apple Carplay + Android Auto



# 2023 JEEP GRAND WAGONEER SERIES II 16 3.0L TT 4X4 GCC 0Km

\* الأداء:

ناقل حركة أوتوماتيكي ب 8 سرعات

عدد الأسطوانات: 6 أسطوانات

سعة المحرك: 3.0 توين توربو

العزم: 677 نيوتن.متر

عدد الأحصنة: 510 حصان

دفع رباعي 4X4

\* المواصفات الإضافية:

Quadra Drive II

Gear Limit

INTEGRATED TIRE COMPRESSOR KIT

ADJUSTABLE ROOF RAIL CROSSBARS

8 مراتب

كاميرا بزاوية 360 درجة

شاشة بروجكتر أمامي

شاشة إضافية للمرافق

ثلاجة أمامية

عداد ديجيتال

مثبت السرعة التكميلي

نظام الهيدروليك لرفع و خفض المركبة مع خاصية التحكم عن بعد

نظام صوتي متقدم من MCINTOSH مع 19 سماعة

خاصية التبريد والتدفئة للمراتب

خاصية المساج للمراتب

فتحة سقف بانوراما مزدوجة

خاصية تثبيت المسار

كاميرا داخلية بزاوية 180 درجة

نظام الملاحة وتحديد المواقع

# 2023 JEEP GRAND WAGONEER SERIES II 16 3.0L TT 4X4 GCC 0Km

خاصية الكشف عن النقطة العمياء

أوتو بارك

التشغيل عن بعد

دخول بصمة

خاصية تدفئة المقود

خاصية المساعدة في نزول المنحدرات

نظام البطارية المزدوجة للبدء والتوقف

نظام مكابح متقدم مع الفرامل التلقائية

وضعية قيادة متعددة

مراتب كهربائية متعددة الوضعية مع خاصية الذاكرة

وحدة تكييف خلفية منفصلة

ابل كاربلاي

اندرويد أوتو

إنارة داخلية محيطيه

دبّة كهربائية مع حساس قدم

مخارج طاقة كهربائية متعددة

شاحن هاتف لاسلكي

ستائر خلفية

عتبات جانبية كهربائية

جنوط مقاس 20 بوصة

# AUTOMAX®

The Boutique Of Muscle Cars, Truck Fanatics & German Automotive Experts.



تتکلم اللغة العربية

**WE SPEAK ENGLISH**

**ON PARLE LE FRANCAIS**

**Nosotros hablamos español**

мы говорим по-русски

**biz o'zbek tilida**

**gaplashamiz**

हम हिंदी बोलते हैं



**automaxgroup.me**



**automax group**



**automax.dxb**



**Automax\_LLC**



**+971 50 602 7200**



**automax.dxb**



**automax.dxb**



**automax.dxb**



**automax\_dxb**



**automax group L.L.C**

**New Auto Market - Dubai - United Arab Emirates**

 **Directions**