







GRAND WAGONEER

AUTOMAX
AUTOMAX 3.0 CRD 4x4



GRAND WAGONEER

GRAND WAGONEER

AUTOMAR



GRAND WAGONEER

AUTOMAX
AUTOMAX K... 3... 30.10.2020 16:00 02.07.2021



GRAND WAGONEER



GRAND WAGONEER







GRAND WAGONEER

AIRBAG

GEAR LIMIT

Top View

LO Front Seat Message
Sync Off 1 2 3



SET+

CANC

RES

SET-





- GEAR
LIMIT +



0

km/h

1. Driver info

P

37°C

NW

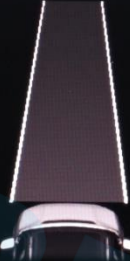

OFF RD

Driver Assist
Press Ok to Zoom In



1. Driver info



Hold OK for Digital

0

km/h
OK for MPH

Speedometer
80 km

P



OFF RD 2

ON OFF
PULL PUSH
OFF ON
OFF ON

NW

5. Off Road



AUTO

Automatic Full
Time 4WD
Adapts to
Road Conditions



P

37°C

OFF RD 2

Maximum
Ground Clearance



Terrain Status
80 km



4. Navigation

NW



Nadd Al Hamar Road

80 km

P

23 Street

37°C



OFF RD



Check entire surroundings



Top View

Rear View

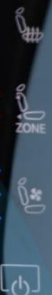
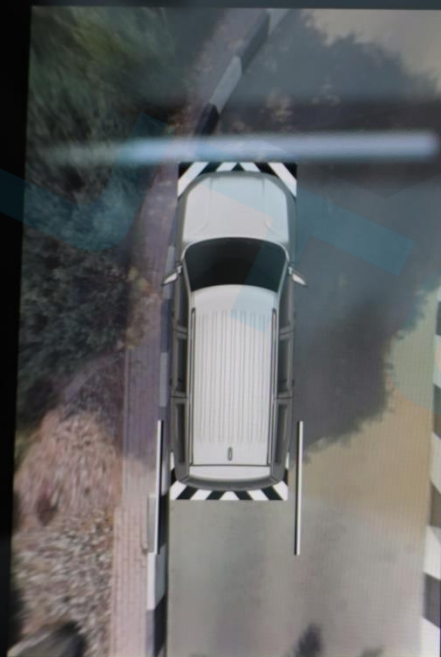

Select a seat to change zoom view



Volume control knob with VOL label and up/down arrows.

TUNE/SCROLL knob with up/down arrows.

Climate control panel with buttons for MAX, REAR, OFF, AUTO, A/C, and fan speed.

Map interface with search bar and street names (18a Street, 7 Street, 23 Street, 25c Street, 27c Street, 36c Street).

HITFM
HITFM ARN NETWORK - 044...
All presets [Play/Pause] [Next]

Phone
Select 'Add Device' to start the pairing process.
Add device Device Manager

Edit pages

VOL [Volume Knob]

TUNE SCROLL [Tune Knob]



Pitch



1°

Roll

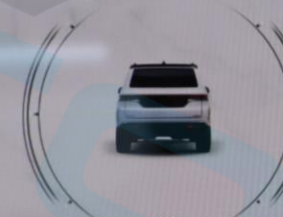

0°

Suspension

OFF RD 2



Edit pages

Home



NW



Volume knob with 'VOL' label and up/down arrows.

TUNE SCROLL knob with up/down arrows and 'TUNE SCROLL' label.

LO [Icons] 1:34 FM HITFM [Icons] LO

Front Seats Massage Rear

Heat
Vent

Front defrost

Heat
Vent

Max A/C A/C Max Rear

Sync Off < 1 2 3 4 5 6 7 > Auto



ZONE

VOL



ZONE

TUNE/SCROLL



Home Music Comfort NW A Phone Car Grid

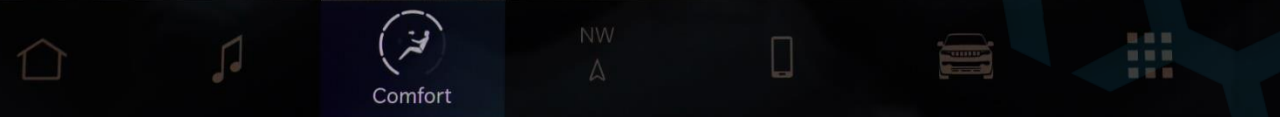

Wednesday, 2 October 2024 [Settings]

Shortcut menu with icons and a vertical slider.

shortcuts

Icons to drag to status bar above

37° OUT
Temperature

Profiles

Notifications

Fam Cam

Device Manager

Sync



LO [Icons] 1:34 [FM] HITFM [Icons] LO

Front **Seats** Massage Rear

| Control | Driver | Psgr. |
|----------------|--------------|--------------|
| Lumbar Up/Down | - [Slider] + | - [Slider] + |
| Lumbar In/Out | - [Slider] + | - [Slider] + |
| Back Bolster | - [Slider] + | - [Slider] + |
| Thigh Bolster | - [Slider] + | - [Slider] + |



ZONE [Icons]

VOL [Slider]

ZONE [Icons]

TUNE/SCROLL [Slider]

START ENGINE STOP

Home [Icon] Music [Icon] **Comfort** [Icon] NW [Icon] Phone [Icon] Car [Icon] [Grid] [Icon]

LO [Icons] 1:35 FM HITFM [Icons] LO

Front Seats **Massage** Rear

Waterfall

Lower back **High** High

Med Med

Extend Extend

Low Low

Low extend Low extend

Off Off

Rock climb Rock climb

Driver Psgr.

VOL [Home] [Music] **Comfort** [NW] [Phone] [Car] [Grid] TUNE/SCROLL

[Left Arrow] [Right Arrow] [MAX] [REAR] [OFF] [AUTO] [A/C] [Right Arrow]

LO 1:35 FM HITFM LO

22° Front Seats Massage Rear 22°

Lock rear

SYNC to driver Off 1 2 3 4 5 6 7 Auto

VOL TUNE SCROLL

Home Music Comfort NW A Phone Car Grid

MAX REAR OFF AUTO A/C

LO | 1:36 HITFM | LO

Off road | **Controls** | Settings

| | | |
|------------------------|----------------------------|-----------------------|
| Mirror Dimmer | 2nd row headrest fold | 3rd row headrest fold |
| Pass screen Screen off | Passenger screen power off | Power Side Step |
| Surround camera | FamCam | Rear View camera |

MAX OFF

ZONE 1

ZONE 2

LO [Icons] 1:36 FM HITFM [Icons] LO

Vehicle Dynamics

Steering Angle: 0°

Transfer Case: Unlocked

Rear Axle Locker: Unlocked

Suspension 4WD HIGH 55°21'60" E 25°10'07" N Altitude -26 m AUTO

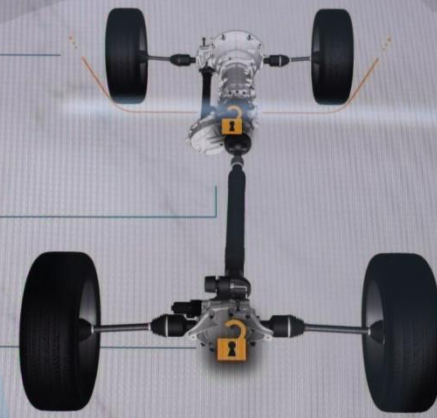

VOL

Home Music Phone NW A Vehicle [Grid]

TUNE/SCROLL

[MAX] [REAR] [Icons] [AUTO] [A/C]

Vehicle Dynamics

Accessory Gauges

Pitch & Roll

Selec-Terrain

Suspension

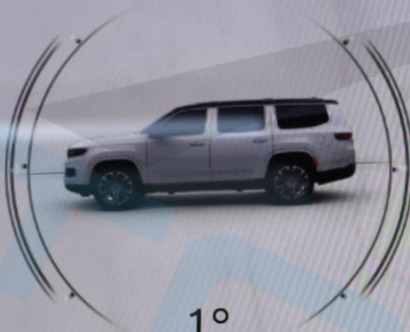

1°

Pitch

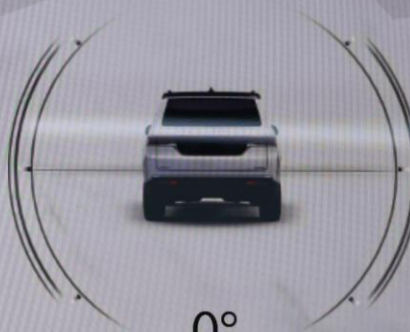

0°

Roll

4WD HIGH

55°21'60" E

25°10'07" N

Altitude -26 m

AUTO



NW



Vehicle



TUNE/SCROLL

LO 1:37 FM HITFM LO

Vehicle Dynamics

Accessory Gauges

Pitch & Roll

Selec-Terrain

Suspension



4WD HIGH 55°21'60" E 25°10'07" N Altitude -26 m AUTO



NW
A



Vehicle



TUNE/SCROLL

MAX REAR OFF AUTO A/C

- Automatic Emergency Braking >
- Display Active Lane Management >
- Entertainment screens ParkSense ⓘ Only warning Warning + braking assist
- My profile Front ParkSense Volume ⓘ Low Med High
- Safety & driving assistance** Rear ParkSense Volume ⓘ Low Med High

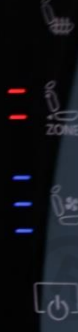
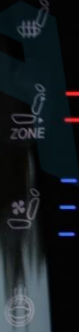

LO [Icons] 13:38 FM HITFM [Icons] LO

Off road Controls **Settings**

Side Distance Warning

Display Blind Spot Alert ⁱ Off Lights Lights + chime

Entertainment screens Electric power steering default ⁱ Normal Sport Comfort

My profile Power Side Step ⁱ Auto Store

Safety & driving assistance Hill Start Assist ⁱ

Tire Fill Assist ⁱ

VOL

[Volume knob]

[Home icon] [Music icon] [Sport icon] [NW A icon] [Phone icon] **Vehicle** [App grid icon]

TUNE/SCROLL

[Tune/Scroll knob]

[Zone icon]

[Power icon]

LO [Icons] 13:38 FM HITFM [Icons] LO

Favourites All

Media

Comfort

Nav

Phone

| | | | | |
|-----|----------|----------------|-----------------|-----------|
| AM | AM radio | Audio settings | Auxiliary cable | Bluetooth |
| DAB | DAB | Device Manager | FM radio | Media |

VOL

TUNE/SCROLL

Home Music Phone NW Car Apps

LO [Icons] 13:38 FM HITFM [Icons] LO

Favourites All

Media

Comfort

Nav

Phone

DAB

Device Manager

FM radio

Media

USB 1

USB 2

The image shows a car's infotainment screen with a light-colored background and a grid of application icons. At the top, there is a status bar with 'LO' on both sides, a microphone icon, and the time '13:38'. Below this, a 'Favourites' bar is visible with 'All' selected. The main area contains a vertical sidebar on the left with 'Media', 'Comfort', 'Nav', and 'Phone' buttons. The central area features icons for 'DAB', 'Device Manager', 'FM radio', 'Media', 'USB 1', and 'USB 2'. Each icon has a star icon next to it, indicating it is a favorite. The 'Device Manager' icon is highlighted with a blue star. At the bottom of the screen, there is a dock with icons for home, music, navigation, phone, and a car icon, along with an 'Apps' button.

ZONE

ZONE

ZONE

VOL

ZONE

ZONE

ZONE

TUNE SCROLL

Favourites

All

Media

Comfort

Nav

Phone



Comfort



Driver Heat



Driver Vent



Heated wheel



Massage seats



Psgr heat



Psgr vent



NW
A



Apps



AUTO

A/C



LO [Icons] 13:38 FM HITFM [Icons] LO

Favourites All

Media

Comfort

Nav

Phone

Android Auto

Device Manager

Phone

Apps

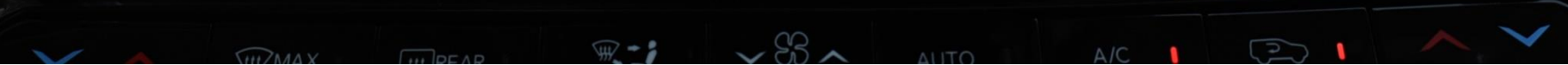
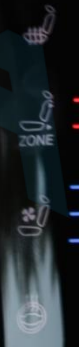

LO [Icons] 13:39 FM HITFM [Icons] LO

Favourites All

Phone

Vehicle

System

Other

| | | | |
|----------------|----------------|------------------|-------------------------|
| Ambient Colour | Audio settings | Controls | FamCam |
| Mirror dimmer | Off Road Pages | Rear view camera | Select. tyre fill alert |

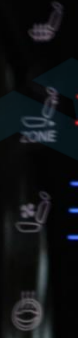

Home Music Navigation Phone Vehicle Apps

MAX REAR [Icons] AUTO A/C [Icons]

Favourites All

- Phone
- Vehicle**
- System
- Other

- Settings
- Surround camera
- Vehicle
- 2nd row headrest...
- 3rd row headrest...

Favourites All

Phone

Vehicle

System

Other



Driver profiles



Software updates



Stored Notificati...



NW
A



Apps

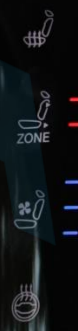

MAX

REAR



OFF

AUTO

A/C



LO [Icons] 13:39 FM HITFM [Icons] LO

Favourites All

- Phone
- Vehicle
- System
- Other



McIntosh



Relax



Tutorials

Home Music Activity NW A Phone Car Apps

ZONE [Icons]
VOL [Knob]

ZONE [Icons]
TUNE/SCROLL [Knob]

[Icons] MAX REAR [Icons] OFF AUTO A/C [Icons]

LO [Icons] 13:41 FM HITFM [Icons] LO

< Ambient Color Personalization

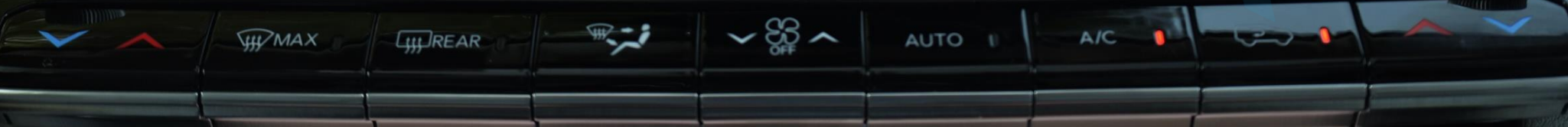
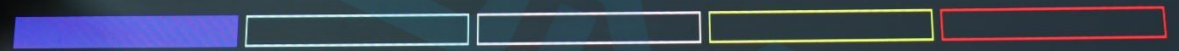
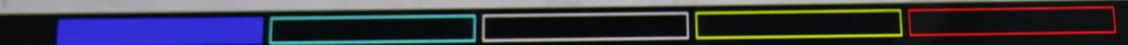

Показать весь доступный диапазон



Вид сверху

Вид сзади



VOL

TUNE SCROLL



AUTO

A/C



22.0°

Front

Seats

Massage

Rear

Screen Off

22.0°

Выбрать сиденье, чтобы изменить масштабированный вид

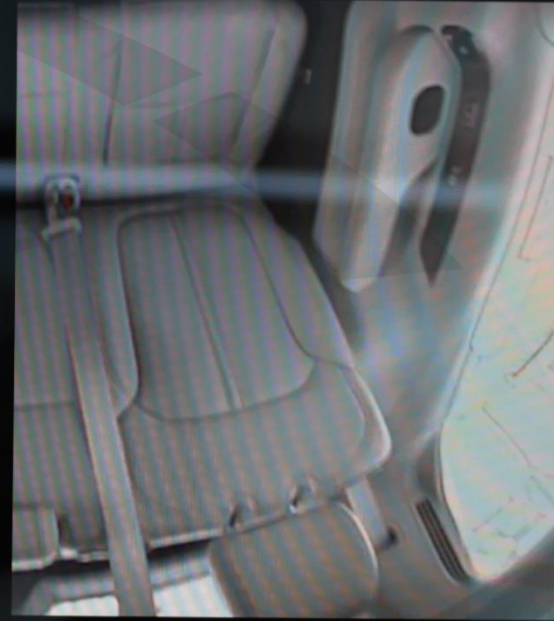

Управление климатом

↑&G

ZONE
*
⏻

↕
TUNE/
SCROLL

MAX REAR OFF AUTO A/C

Низ. | | 13:48 HITFM | Низ.

Поиск Street

22 Street 25c Street 23 Street 13b Street
31 Street 27c Street 36c Street Nadd Al Hamar Road

3D

40

VOL

C3
▲
Nav

TUNE SCROL

START ENGINE STOP

Наклон



1°

Крен

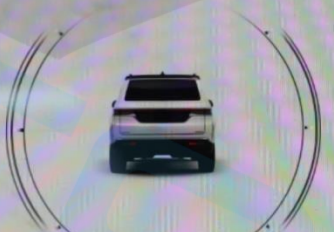

0°

Подвески

OFF RD 2



Редактировать страницы

Главная



C3
A



VOL

TUNE
SCROLL

| | Передн. | Сиденья | Массаж | Задний | |
|---------------|---------|---------|--------|---------|---------------|
| Расслабл. | | | | | Расслабл. |
| Низ спины | Гром. | | | Гром. | Низ спины |
| Растягив. | Сред. | | | Сред. | Растягив. |
| Низ растягив. | Низ. | | | Низ. | Низ растягив. |
| Энергичный | Off | | | Off | Энергичный |
| | Водит. | | | Пассаж. | |

VOL TUNE/SCROLL

Home Music Comfort C3 Phone Car App

Navigation and climate control buttons: A/C, AUTO, and directional arrows.

Низ. 13:47 FM HITFM Низ.

Передн. Сиденья Массаж Задний

Пер. обдув

Об. Вен

Макс. А/С A/C Максим. Задний

Синхр. Off 1 2 3 4 5 6 7 Авт.

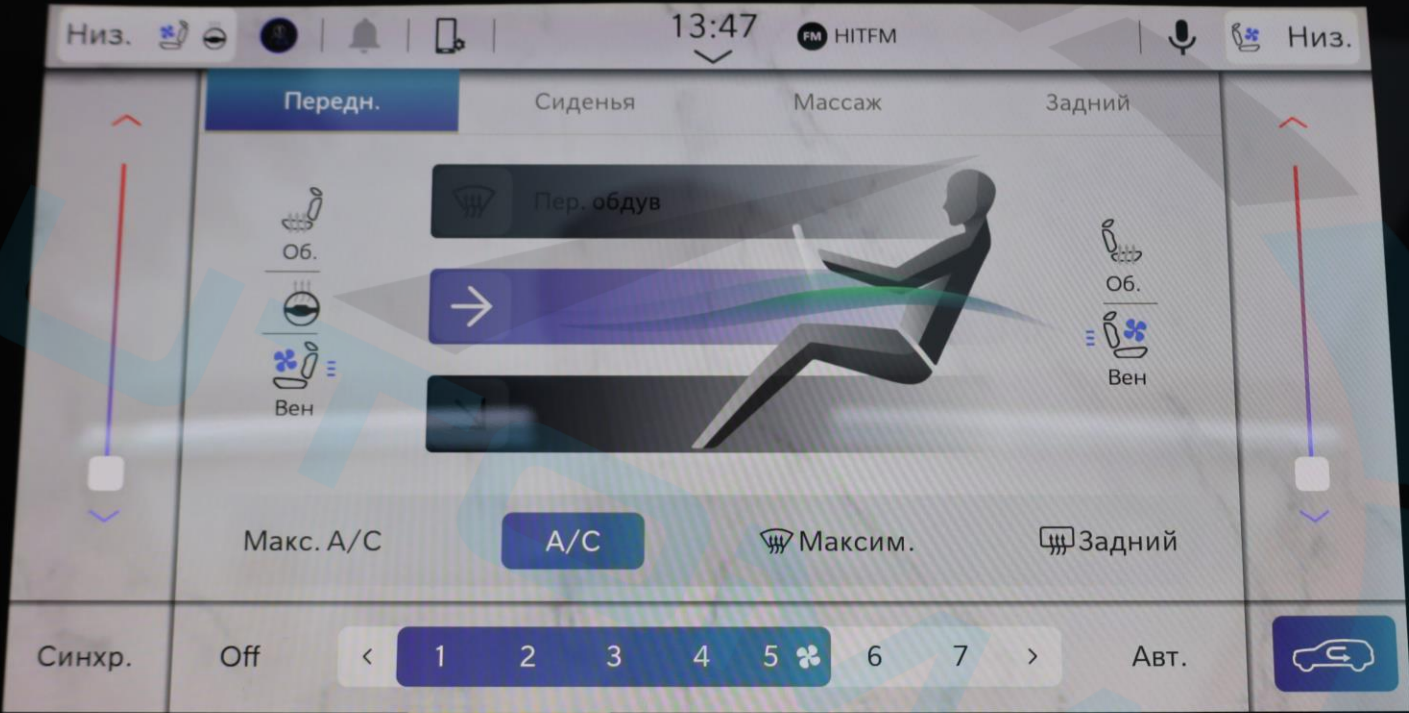

**Динамика
автомобиля**

Угол поворота
рулевого колеса:
0°

**Вспомог.
приборы**

Раздаточная
коробка:
Разблокирована

**Попер.
перемещения**

Selec-Terrain

Блокиратор
заднего моста:
Разблокирована

Подвески

4WD HIGH 55°21'60" В 25°10'07" С Высота -26 м AUTO

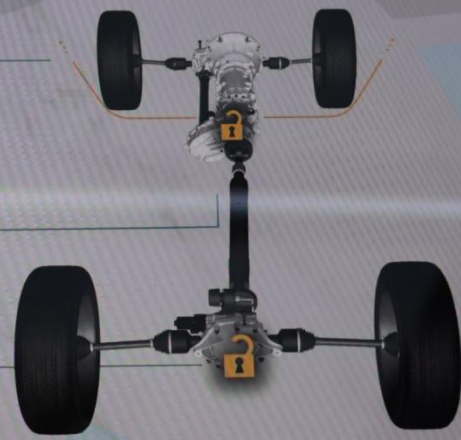

VOL

TUNE SCROLL

START ENGINE STOP

تحقق من البيئة المحيطة بأكملها



الرؤية العلوية

الرؤية الخلفية

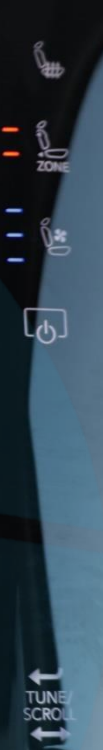
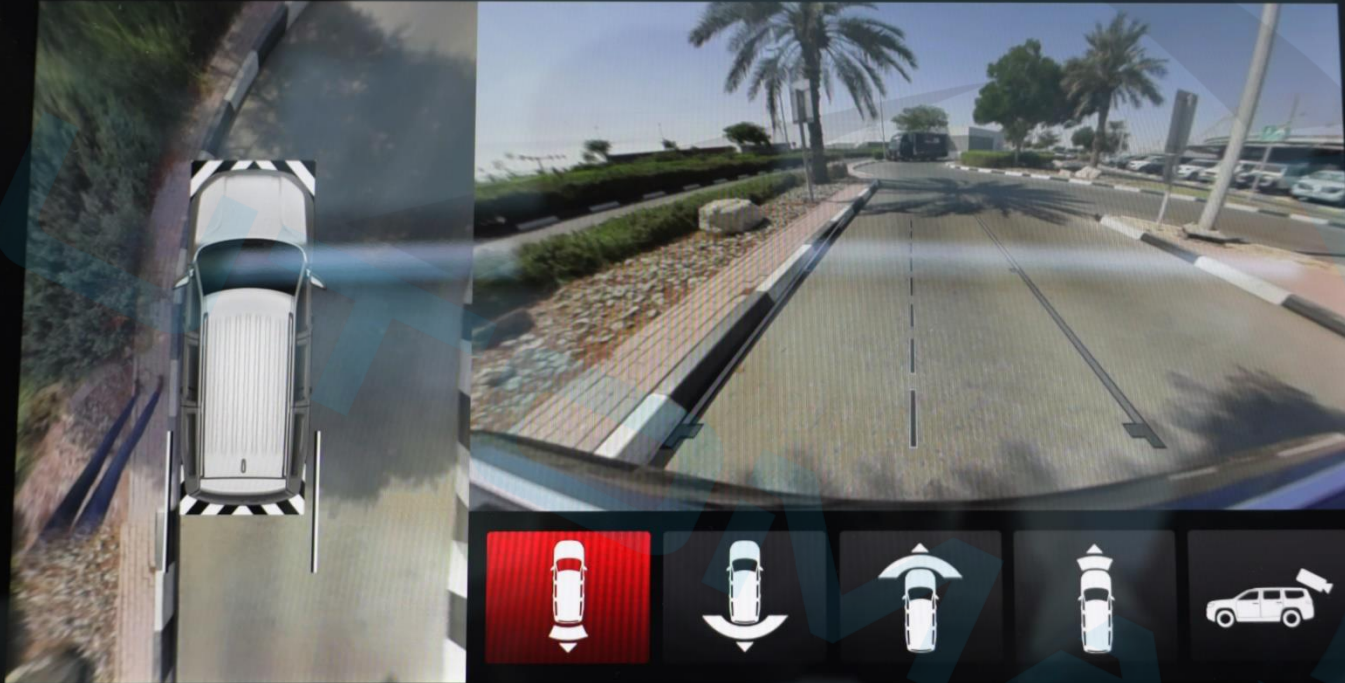

اختر مقعد لتغيير تكبير العرض



TUNE/SCROLL

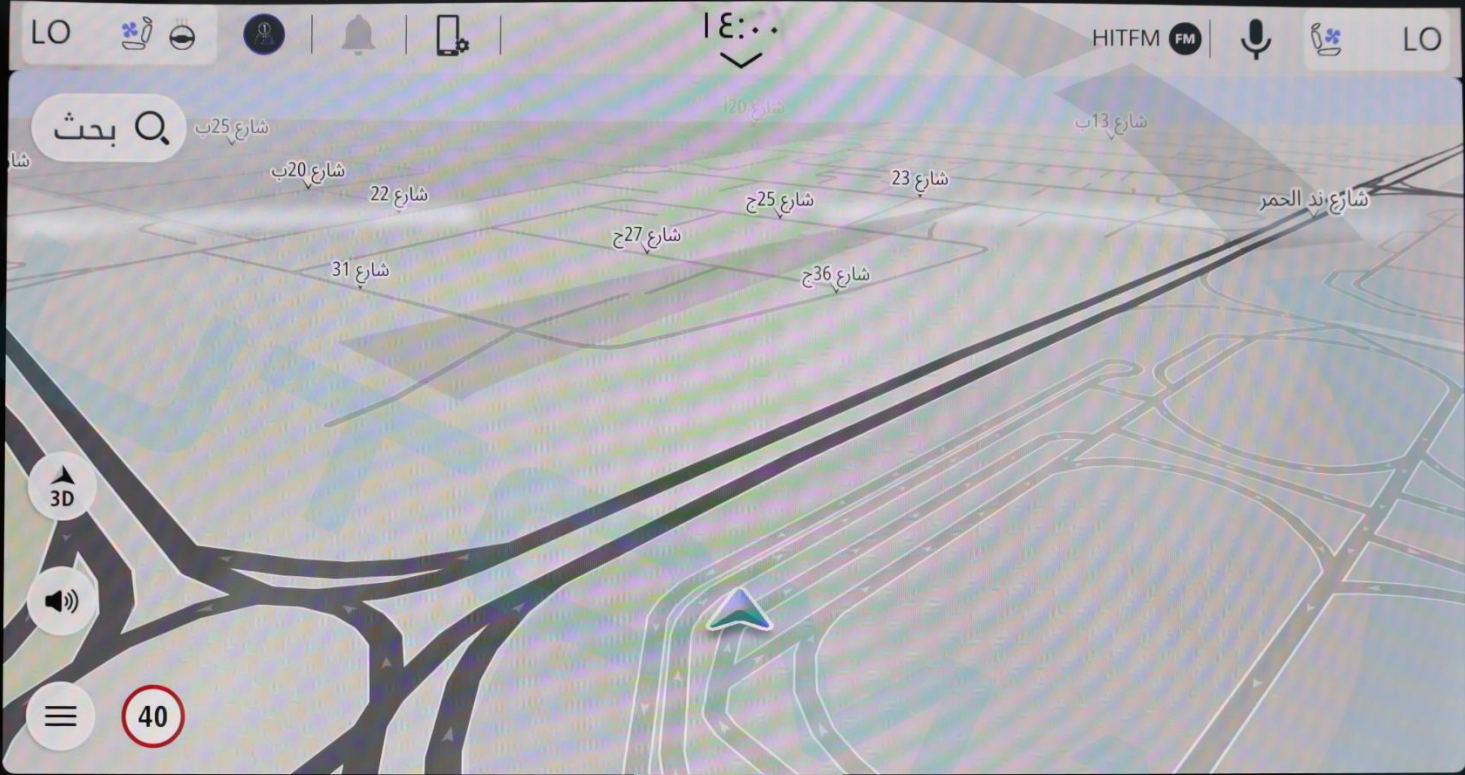

موسيقى
منازل
ZONE
منازل
منازل

موسيقى
منازل
ZONE
منازل
منازل

VOL
↑ ↓

TUNE/SCROLL
↑ ↓



NW
▲
Nav



MAX

REAR



نظام التعليق

OFF RD 2



انحدار

1°

التفاف

0°



تحرير الصفحات

LO [Icons] 13:09 HITFM FM [Icons] LO

الأمامي المقاعد تدليك خلفي

إزالة الصقيع الأمامي

تسخين تبريد

تسخين تبريد

أقصى تكييف الهواء حد أقصى خلفي

مزامنة Off 1 2 3 4 5 6 7 ألي

ZONE

ZONE

VOL

TUNE/SCROLL



NW



Comfort



LO 14:00 HITFM FM LO

الاسترخاء

الاسترخاء

أسفل الظهر

أسفل الظهر

تمديد

تمديد

تمديد أسفل الظهر

تمديد أسفل الظهر

شديد

شديد

الأمامي المقاعد تدليك خلفي

عالي

عالي

متوسط

متوسط

منخفض

منخفض

Off

Off

السائق

الراكب



NW
A



Comfort



TUNE/SCROLL

LO [Icons] 14:00 HITFM FM [Icons] LO

الأمامي المقاعد تدليك **خلفي**

°٢٢

قفل الخلفي

↘

المزامنة مع السائق Off

< 1 2 3 4 5 6 7 >

آلي

ZONE

ZONE

VOL

TUNE/SCROLL

Comfort

LO



١٤:٠٦

HITFM FM



LO

ديناميكيات
المركبة

زاوية التوجيه:
0°

ملحقات
المقاييس

حالة النقل:
غير مغلق

انحدار و
التفاف

Selec-Terrain

قفل المحور
الخلفي:
غير مغلق

نظام التعليق

4WD
HIGH

55°21'60" E

25°10'07" N

ارتفاع -26 m

AUTO

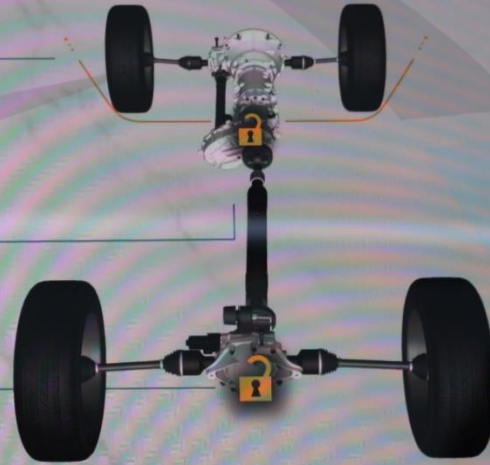

المركبة



NW
A



VOL

TUNE/
SCROLL



Тел.



АВТОМ.

Система



Navigation arrows, MAX, REAR, OFF, AUTO, A/C, Car icon, Navigation arrows

LO Front Seats Massage Rear Screen Off LO

Front Defrost

Sync Off 1 2 3 4 5 6 7 Max A/C

Navigation arrows, MUTE, AUTO HOLD ON, OFF, OFF, ON, OFF, TOW/HAUL ON, Navigation arrows



MAX

REAR



AUTO

A/C



Front

Seats

Massage

Rear

Screen Off

Lumbar Up/Down

— +

Lumbar In/Out

— +

Back Bolster

— +

Thigh Bolster

— +



Driver



Passenger

Lumbar Up/Down

— +

Lumbar In/Out

— +

Back Bolster

— +

Thigh Bolster

— +



MUTE



AUTO HOLD ON



PO ON

OFF

TOW HAUL ON





AUTO

A/C



Front Seats Massage Rear Screen Off

| | | | | | |
|------------|------|---------------|------------------|------|------------|
| Waterfall | High | <p>Driver</p> | <p>Passenger</p> | High | Waterfall |
| Lower Back | Med | | | Med | Lower Back |
| Extend | Low | | | Low | Extend |
| Low Extend | Off | | | Off | Low Extend |
| Rock Climb | | | | | Rock Climb |



MUTE



AUTO HOLD ON



ON



TOW/HAUL ON



P

Home



Controls

Vehicle cameras

Fam Cam

Rear View

Check entire surrounding



Surround View

Top View

Rear View





AND WAGON

Home

Controls

Audio 

 Bluetooth

 FM

 AM

More...

Video 

 USB 1

 USB 2

More...

HDMI 

HDMI
HIGH DEFINITION MULTIMEDIA INTERFACE



Connect HDMI cable

Home



Controls

Navigation



Search



Favourites

Recent

Devices



0 devices connected



Pair new device



Manage Bluetooth headphones

Cameras

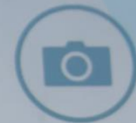

View vehicle
Camera apps



W A G O

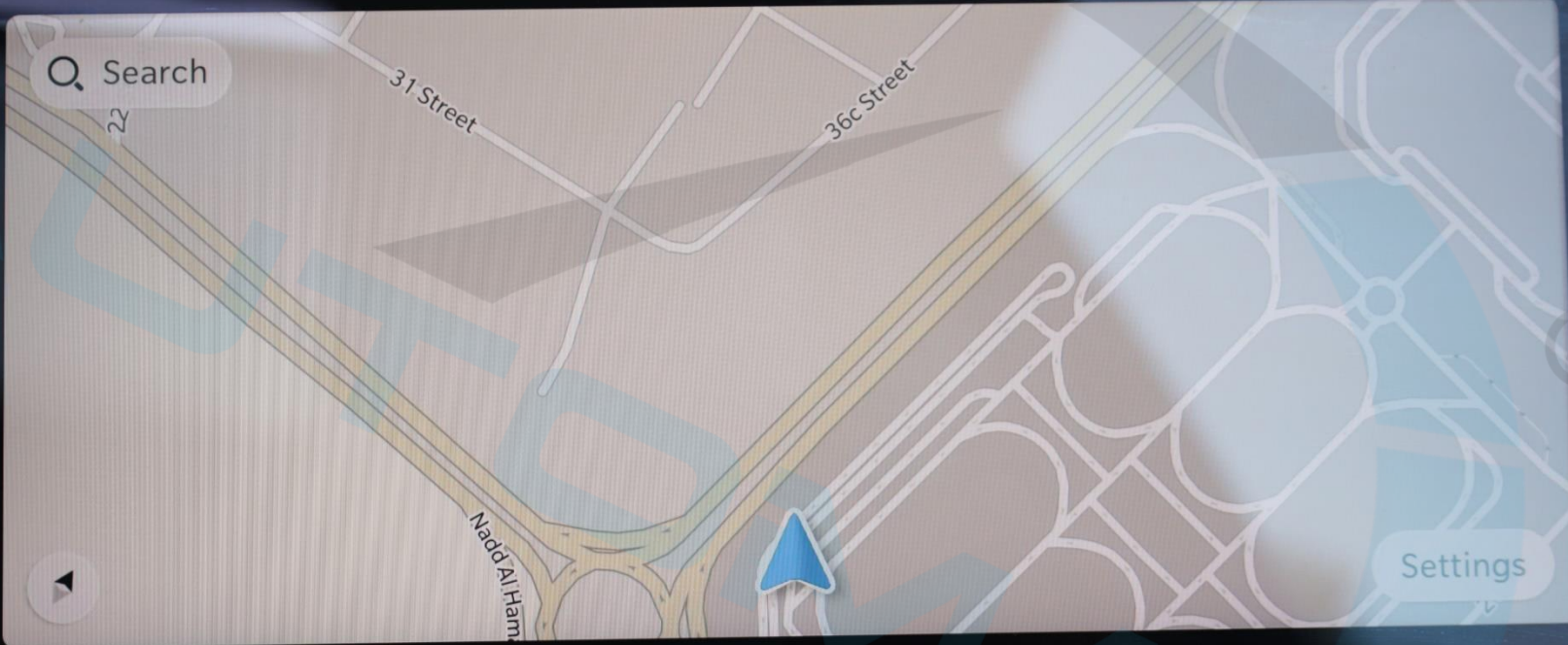

Home

Controls

Search

31 Street

36c Street

Nadd Al Ham

Settings

C R A N D W A G O N



Sync

Off

1

2

3

4

5



6

7

Max A/C



MUTE



OFF

AUTO
HOLD
ON



OFF



OFF



ON



OFF

TOW/
HAUL
ON



P R N D

ROCK
SAND/MUD
SNOW
AUTO
SPORT



Sync Off 1 2 3 4 5 6 7 Max A/C

MAP AUTO OFF AUTO HOLD ON L4 OFF TRIP ON OFF PWR FOLD ON OFF

P R N D

ROCK SAND/MUD SNOW AUTO SPORT

← 1 2 3 4 5 →

4WD LOW

4x4

4N



22.0°

Rear Comfort

Screen Off

22.0°

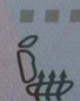
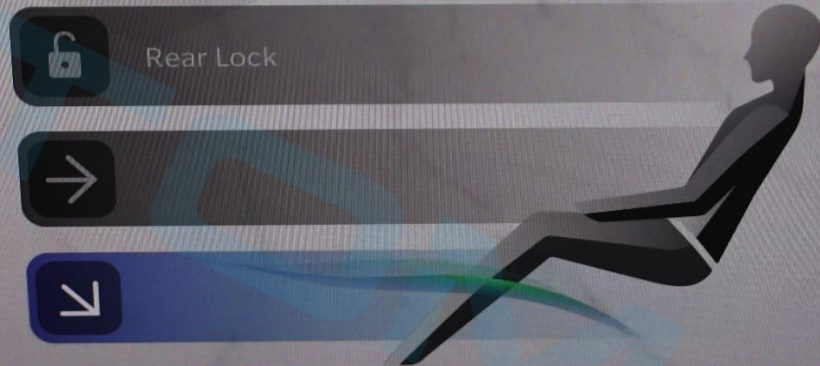
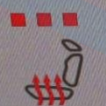

Sync

Off

1

2

3

4



5

6

7

Auto

230 V AC
150 W



12V DC















OFF



ON



OPEN



CLOSE

TILT



DOWN

OPEN



CLOSE



START
ENGINE
STOP

RUN

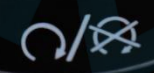





12V DC





AUTO

P

R

D



P

PULL ON





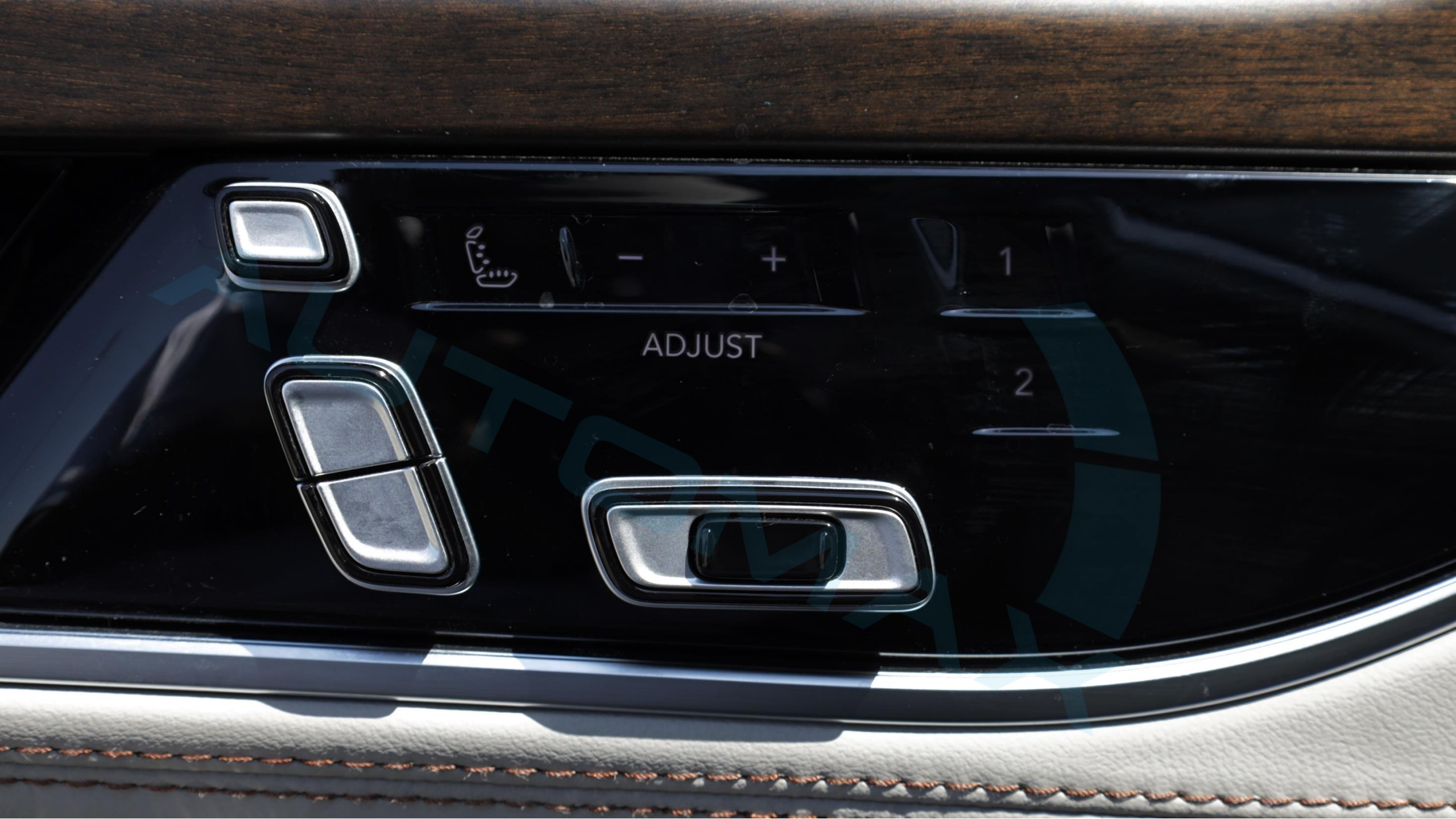

ADJUST

1

2



McIntosh

PDI - OK
DATE 23.09.2024





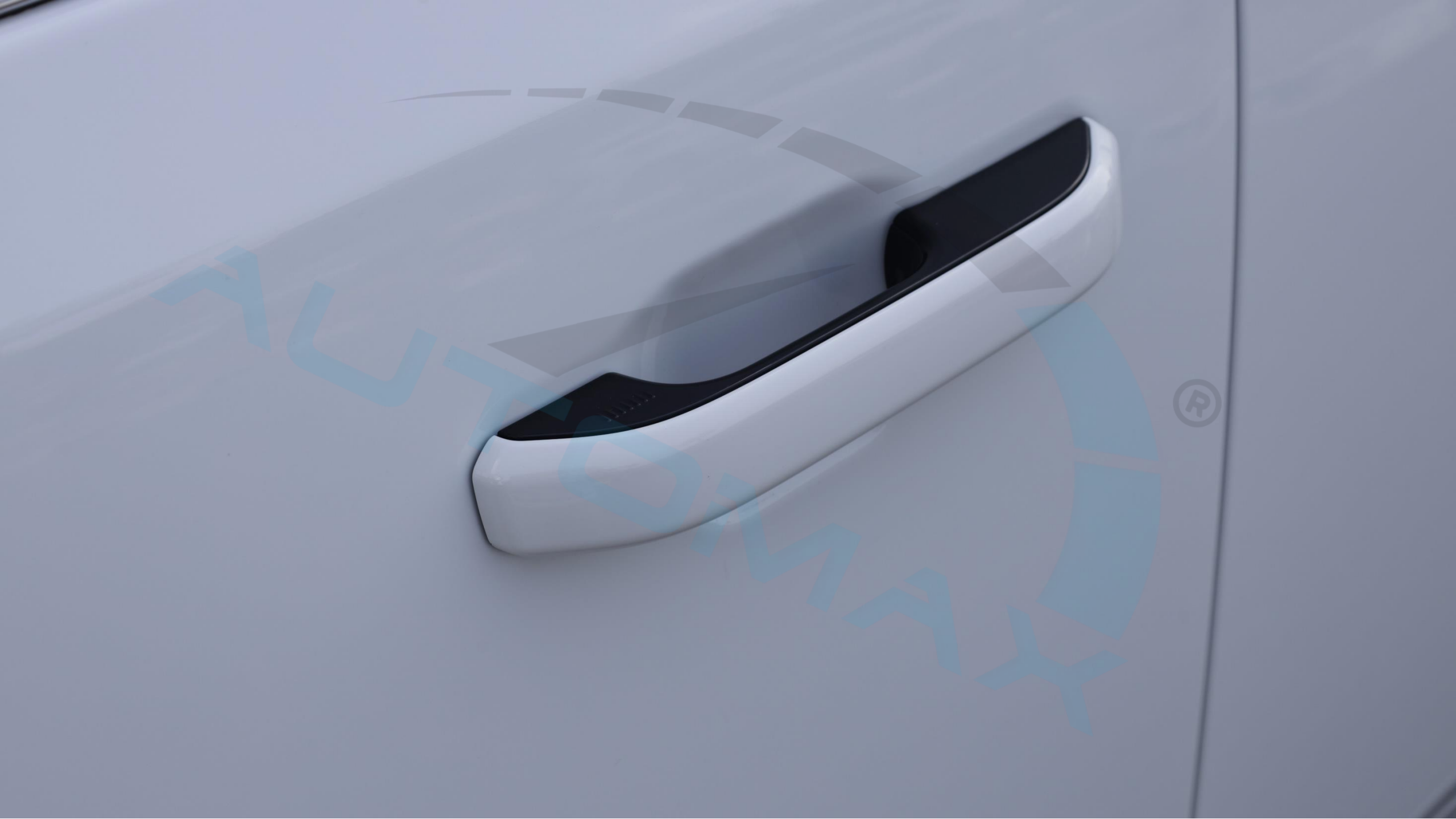







GRAND WAGONEER











GRAND WAG





لمشاهدة صورة السيارة بزاوية 360 درجة إضغط على الصورة أعلاه

Для просмотра автомобиля в формате 360°, пожалуйста, нажмите на фото выше.

To view the 360° degree please press on the picture above

2023 JEEP GRAND WAGONEER SERIES II 16 3.0L TT 4X4 GCC 0Km

Бренд: Jeep

Brand: Jeep

الماركة: جيب

Категория: GRAND WAGONEER

Category: GRAND WAGONEER

الفئة: GRAND WAGONEER

Модель: SERIES II LUXURY

Model: SERIES II LUXURY

الموديل: SERIES II LUXURY

Год: 2023

Year: 2023

السنة: 2023

Километров: 0 Km

Kilometers: 0 Km

كيلومترات: 0 كم

Двери: 4 Doors

Doors: 4 Doors

عدد الأبواب: 4 أبواب

Цвет: Белый

Color: Bright White/ Sea Salt

اللون: أبيض

Цилиндр: 6

Cylinder: 6 Cylinders

عدد الأسطوانات: 6 أسطوانات

Лошадиные силы: 510 HP

Horsepower: 510 HP

عدد الأحصنة: 510 حصان

Трансмиссия: Автоматическая

Transmission: Automatic

نوع النقل: نقل أوتوماتيكي

Топливо: Бензин

Fuel: Gasoline

نوع الوقود: بنزين

4X4

4X4

المواصفات خليجية
4X4

2023 JEEP GRAND WAGONEER SERIES II 16 3.0L TT 4X4 GCC 0Km

LEATHER TRIMMED BUCKET SEATS
SEA SALT/BLACK
MIDDLE EAST EQUIPMENT GROUP
OFF ROAD GROUP II
FLEXIBLE SEATING GROUP
AUX BATTERY
40/20/40 2ND ROW BENCH PWR TIP/SLIDE
REMOVABLE ASH TRAY
8 PASSENGER SEATING
8-SPD AUTO 8HP75 TRANS (BUY-US)
3.0L 16 HURRICANE HO TWIN TURBO ESS
AUTO DIM EXTERIOR DRIVER MIRROR
CIGAR LIGHTER
GPS NAVIGATION
GPS ANTENNA INPUT
ACTIVE NOISE CONTROL SYSTEM
EXT. MIRRORS W/SUPPLEMENTAL SIGNALS
EXTERIOR MIRRORS W/ARABIC LETTERING
EXTERIOR MIRRORS W/MEMORY
AUTO ADJUST IN REVERSE EXT MIRRORS

HEATED EXTERIOR MIRRORS
EXTERIOR MIRRORS APPROACH LAMPS
BLACK ROOF
QUADRA DRIVE II BADGE
U.S. EMISSIONS W/OBD I
INTEGRATED TIRE COMPRESSOR KIT
BRIGHT WHITE CLEAR COAT
ALL RADIO EQUIPPED VEHICLES
12.0" TOUCHSCREEN DISPLAY
FRONT PASSENGER INTERACTIVE DISPLAY
2ND ROW DUAL CHG-ONLY USB PORTS
DIGITAL AUDIO BROADCASTING
ALL R1 HIGH RADIOS
BRIDGESTONE BRAND TIRES
ALL ALUMINUM WHEELS
FUEL TANK SKID PLATE SHIELD
TRANSFER CASE SKID PLATE SHIELD
FRONT AXLE SKID PLATE
STOP-START DUAL BATTERY SYSTEM
10 ADDITIONAL GALLONS OF GAS

2023 JEEP GRAND WAGONEER SERIES II 16 3.0L TT 4X4 GCS OKm

Quadra Drive II

INTEGRATED TIRE COMPRESSOR KIT

ADJUSTABLE ROOF RAIL CROSSBARS

8 местный

Зимний Пакет

Gear Limit

Вентиляция Сидений

Подогрев Сидений

Сиденья с функцией массажа

Рулевое Колесо с Подогревом

Регулируемые Сиденья с Памятью Позций

Дистанционный Запуск Двигателя

Система Мониторинга Слепых Зон

Бесключевой Доступ

Регулировка Режимов Вождения

Подрулевые Лепестки

Пневмоподвеска

Дистанционное управление пневмоподвеской

Адаптивный Круиз-контроль

ДИСПЛЕЙ ДЛЯ ПАССАЖИРА

Камера Наблюдения Внутри Салона

Холодильник

Контурная Подсветка Салона

Система Экстренного Торможения

Контроль Полосы Движения

Проекция на лобовое стекло

MCINTOSH Премиальная Мультимедийная Система С 19-МИ ДИНАМИКАМИ

Камера 360 Градусов

Панорамная Крыша

Беспроводная Зарядка

Система Помощи При Спуске с Горы

Датчик Давления в Шинах

Розетка

Задние Шторки

Система «Старт-Стоп»

Выдвижная Боковая Подножка

Автопарковка

R 20"

Apple Carplay + Android Auto

2023 JEEP GRAND WAGONEER SERIES II 16 3.0L TT 4X4 GCC 0Km

* الأداء:

ناقل حركة أوتوماتيكي ب 8 سرعات

عدد الأسطوانات: 6 أسطوانات

سعة المحرك: 3.0 توين توربو

العزم: 677 نيوتن.متر

عدد الأحصنة: 510 حصان

دفع رباعي 4X4

* المواصفات الإضافية:

Quadra Drive II

Gear Limit

INTEGRATED TIRE COMPRESSOR KIT

ADJUSTABLE ROOF RAIL CROSSBARS

8 مراتب

كاميرا بزاوية 360 درجة

شاشة بروجكتر أمامي

شاشة إضافية للمرافق

ثلاجة أمامية

عداد ديجيتال

مثبت السرعة التكميلي

نظام الهيدروليك لرفع و خفض المركبة مع خاصية التحكم عن بعد

نظام صوتي متقدم من MCINTOSH مع 19 سماعة

خاصية التبريد والتدفئة للمراتب

خاصية المساج للمراتب

فتحة سقف بانوراما مزدوجة

خاصية تثبيت المسار

كاميرا داخلية بزاوية 180 درجة

نظام الملاحة وتحديد المواقع

2023 JEEP GRAND WAGONEER SERIES II 16 3.0L TT 4X4 GCC 0Km

خاصية الكشف عن النقطة العمياء

أوتو بارك

التشغيل عن بعد

دخول بصمة

خاصية تدفئة المقود

خاصية المساعدة في نزول المنحدرات

نظام البطارية المزدوجة للبدء والتوقف

نظام مكابح متقدم مع الفرامل التلقائية

وضعية قيادة متعددة

مراتب كهربائية متعددة الوضعية مع خاصية الذاكرة

وحدة تكييف خلفية منفصلة

ابل كاربلاي لاسلكي

اندرويد أوتو لاسلكي

إنارة داخلية محيطيه

دبّة كهرباء مع حساس قدم

مخارج طاقة كهربائية متعددة

شاحن هاتف لاسلكي

ستائر خلفية

عتبات جانبية كهربائية

جنوط مقاس 20 بوصة

AUTOMAX®

The Boutique Of Muscle Cars, Truck Fanatics & German Automotive Experts.



نتكلم اللغة العربية

WE SPEAK ENGLISH

ON PARLE LE FRANCAIS

Nosotros hablamos español

мы говорим по-русски

biz o'zbek tilida

gaplashamiz

हम हिंदी बोलते हैं



automaxgroup.me



automax group



automax.dxb



Automax_LLC



+971 50 602 7200



automax.dxb



automax.dxb



automax.dxb



automax_dxb



automax group L.L.C

New Auto Market - Dubai - United Arab Emirates

 **Directions**