



AUTOMAX

AUTOMAX 3 11 2022

GRAND WAGONEER













GRAND WAGONEER

GRAND WAGONEER

AUTOMAX  
AUTOMAX 3.5 HYBRID





GRAND WAGONEER

AUTOMAX  
AUTOMAX LLC





GRAND WAGONEER



GRAND WAGONEER





GRAND WAGONEER









GRAND WAGONEER

0 km/h P 36°C

Key Fob  
Not Left  
In Vehicle

Top View

START  
ENGINE  
STOP

Lumbar  
Up/Down







EER



SET+



CANC



RES



SET-





- GEAR  
LIMIT +





0  
km/h

АВТОМАТ



4. Navigation

P

38°C

2 St E

Manama Street



AERO





1. Driver Info



Hold OK for Digital

0

km/h

Press OK for MPH

Speedometer  
00000



38°C

AERO





5. Off Road

P

38°C

E



AUTO

Automatic Full

Time 4WD

Adapts to

Road Conditions



AERO

Improved  
Aerodynamics



H



C



Terrain Status



E



F



AERO



5. Off Road

P

38°C

E

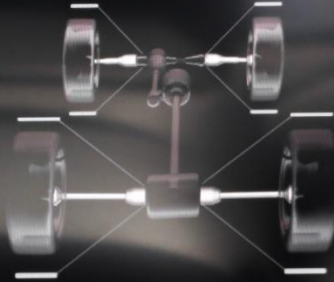

AERO

H

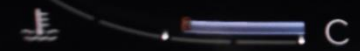

◀

Vehicle Dynamics

▶

E





1. Driver Info

P

38°C

E



AERO



Driver Assist  
Press OK to Zoom Out







Top View

Rear View

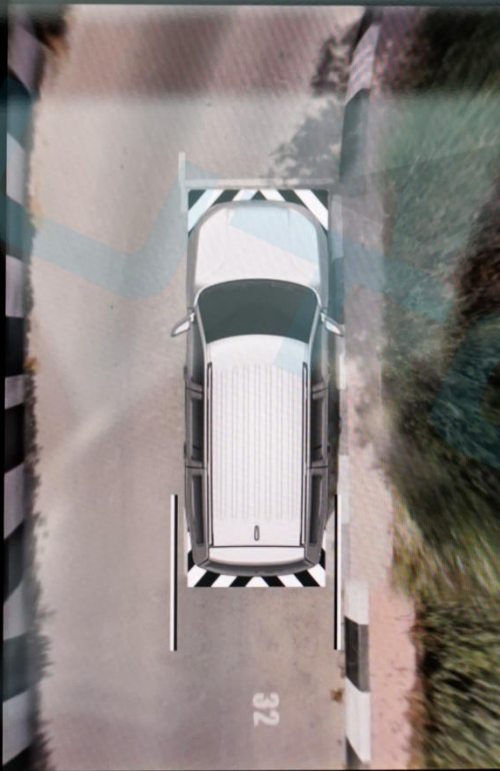



Select a seat to change zoom view

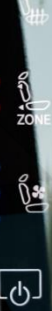
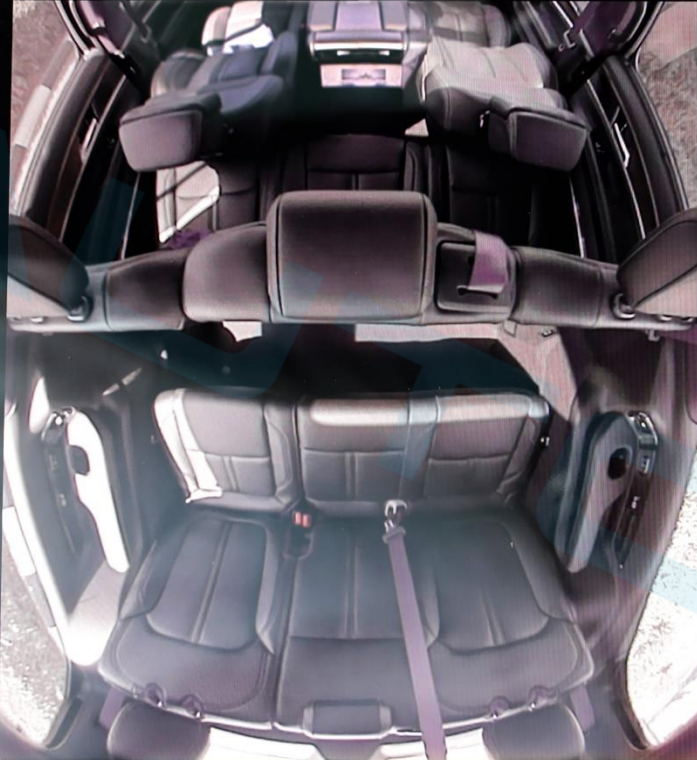

VOL

TUNE/SCROLL



16.0° Front Seats Massage Rear Screen Off 16.0°



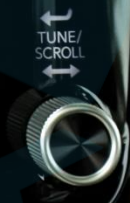



LO | 12:10 DUBAI | LO

Front Seats Massage Rear

Heat  
Vent

Front Defrost

Heat  
Vent

Max A/C A/C Max Rear

Sync Off < 1 2 3 4 5 6 7 > Auto

VOL

TUNE/SCROLL

START ENGINE STOP



LO 12:11 -DUBAI LO

Off Road **Controls** Settings

Mirror Dimmer	2nd Row Headrest Fold	3rd Row Headrest Fold
Pass Screen Screen Off	Pass Screen Power Off	Power Side Step
Surround Camera	FamCam	Rear View Camera



Vehicle

TUNE/SCROLL

MAX REAR OFF AUTO A/C



Vehicle Dynamics

Accessory Gauges

Pitch & Roll

Selec-Terrain

Suspension

Steering Angle: 0°

Transfer Case: Unlocked

Rear Axle Locker: Unlocked

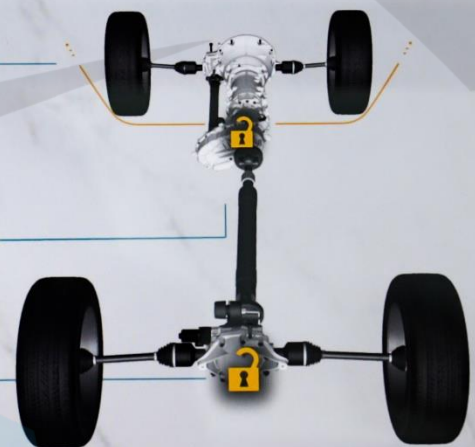

4WD HIGH 55°21'60" E 25°10'07" N Altitude 9 m SPORT



Favorites

All

Media

Comfort

Nav

Phone

AM

AM Radio

Audio Settings

Auxiliary Cable

Bluetooth

DAB

DAB

Device Manager

FM

FM Radio

Media



NW



Apps

START  
ENGINE  
STOP

TUNE  
CROLL



Favorites

All

Media

Comfort

Nav

Phone



Comfort



Driver Heat



Driver Vent



Heated Wheel



Massage Seats



Psgr Heat



Psgr Vent





LO | 12:13 FM- | LO

Favorites All

^

Phone

**Vehicle**

System

Other

^

☆ Ambient Color

☆ Audio Settings

☆ Controls

☆ FamCam

☆ Mirror Dimmer

★ Off Road Pages

☆ Rear View Camera

☆ Select. Tire Fill Alert

v

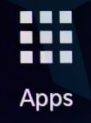



Favorites All

Phone

**Vehicle**

System

Other

Settings









Surround Camera

Vehicle

2nd Row Headrest...

3rd Row Headrest...



LO    |  |  | 12:13  FM- |   LO



Favorites All



Phone



Vehicle

**System**

Other

 Driver Profiles 

 Software Updates 

 Stored No-tifications 

       Apps

TUNE/SCROLL 

START ENGINE TOP 



LO | | 12:13 FM- | LO

Favorites All

^

Phone	☆	☆	☆
Vehicle	McIntosh	Relax	Tutorials
System			
Other			

v

NW Apps

START  
ENGINE  
STOP

ZONE

TUNE  
SCROLL



LO 12:13 FM -DUBAI LO

Ambient Color Personalization

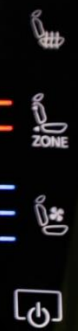

Sync



Vehicle





LO [Icons] 12:10 [Icons] LO

Sources **Playing** Browse Audio Settings

FM- TP FM

FM- DAB [Radio Icon]

[Back] [Menu] [Next]

All Presets | 1 Hold to Save | 2 Hold to Save | 3 Hold to Save | 4 Hold to Save | 5 Hold to Save | 6 Hold to Save | >



NW  
A



TUNE/  
SCROLL



AUTO

A/C







Вид сверху

Вид сзади



TUNE/  
SCROLL

START  
ENGINE  
STOP



AUTO

A/C





Выбрать сиденье, чтобы изменить масштабированный вид



VOL

TUNE/SCROLL



16.0°

Front

Seats

Massage

Rear

Screen Off

16.0°



Низ. 12:14 FM -DUBAI Низ.

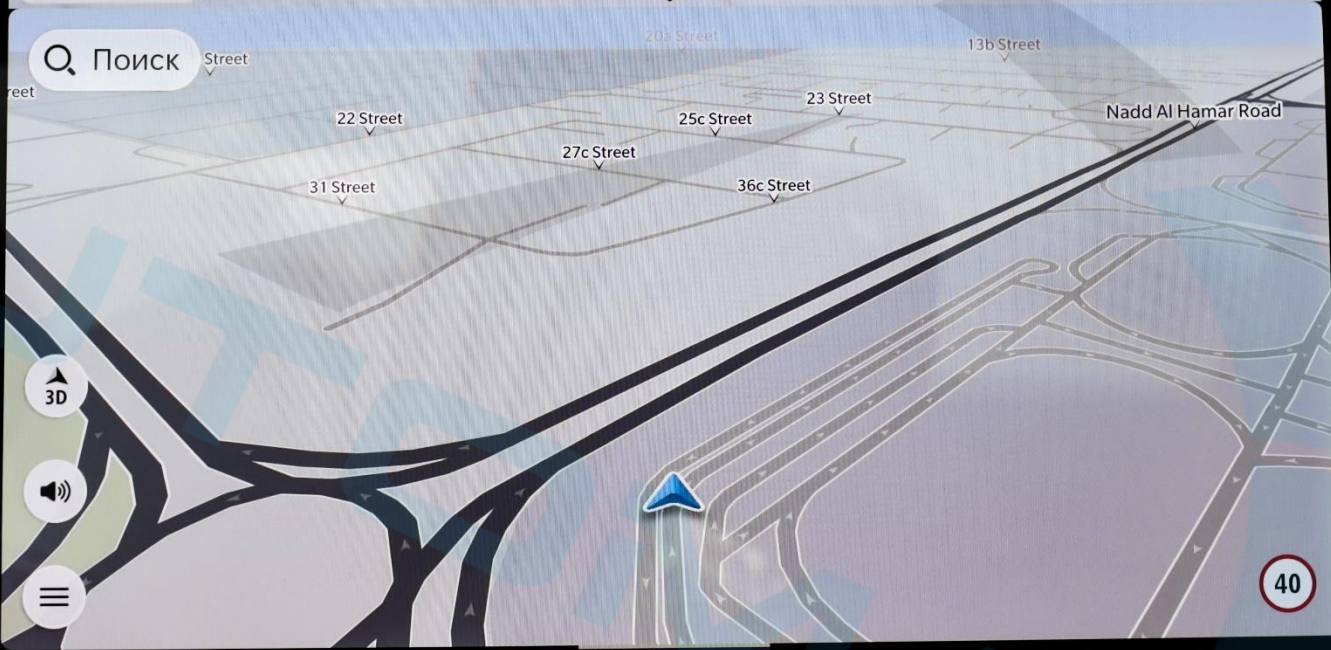

3D  
C3  
Nav



Physical control buttons and knobs including a volume knob on the left, a power button, and a 'TUNE/SCROLL' knob on the right.

Physical control buttons for climate and vehicle settings, including 'MAX', 'REAR', 'OFF', 'AUTO', and 'A/C'.



Избранные Все

Медиа	☆	☆	☆	☆
Comfort	Вент. водит.	Вент. пасс.	Комфорт	Обог. пасс.
Nav	☆	☆	☆	
Тел.	Обог. водит.	Обогрев. рул. кол...	Сиденья с массаж...	





Низ. 12:14 FM FM- Низ.

Бездорожье | **Элементы управления** | Настройки

Затем. зер. зад. вида	Склад. подгол. 2 ряда	Склад. подгол. 3 ряда
<b>Экран пассажира</b> Пит. выкл.	<b>Экран пассажира</b> Питание выкл.	Power Side Step
Кам. круг. обзора	FamCam	Камера зад. вида



MAX REAR OFF AUTO A/C



Динамика автомобиля

Вспомог. приборы

Попер. перемещения

Selec-Terrain

Подвески

Угол поворота рулевого колеса: 0°

Раздаточная коробка: Разблокирована

Блокиратор заднего моста: Разблокирована

4WD HIGH 55°21'60" В 25°10'07" С Высота 9 м SPORT

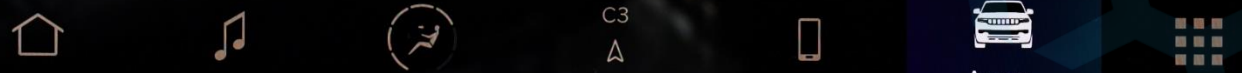
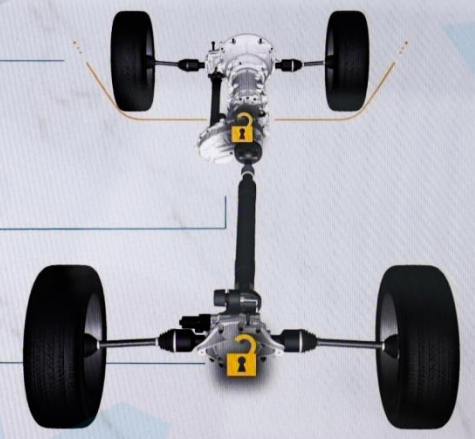





الرؤية الخلفية

الرؤية العلوية

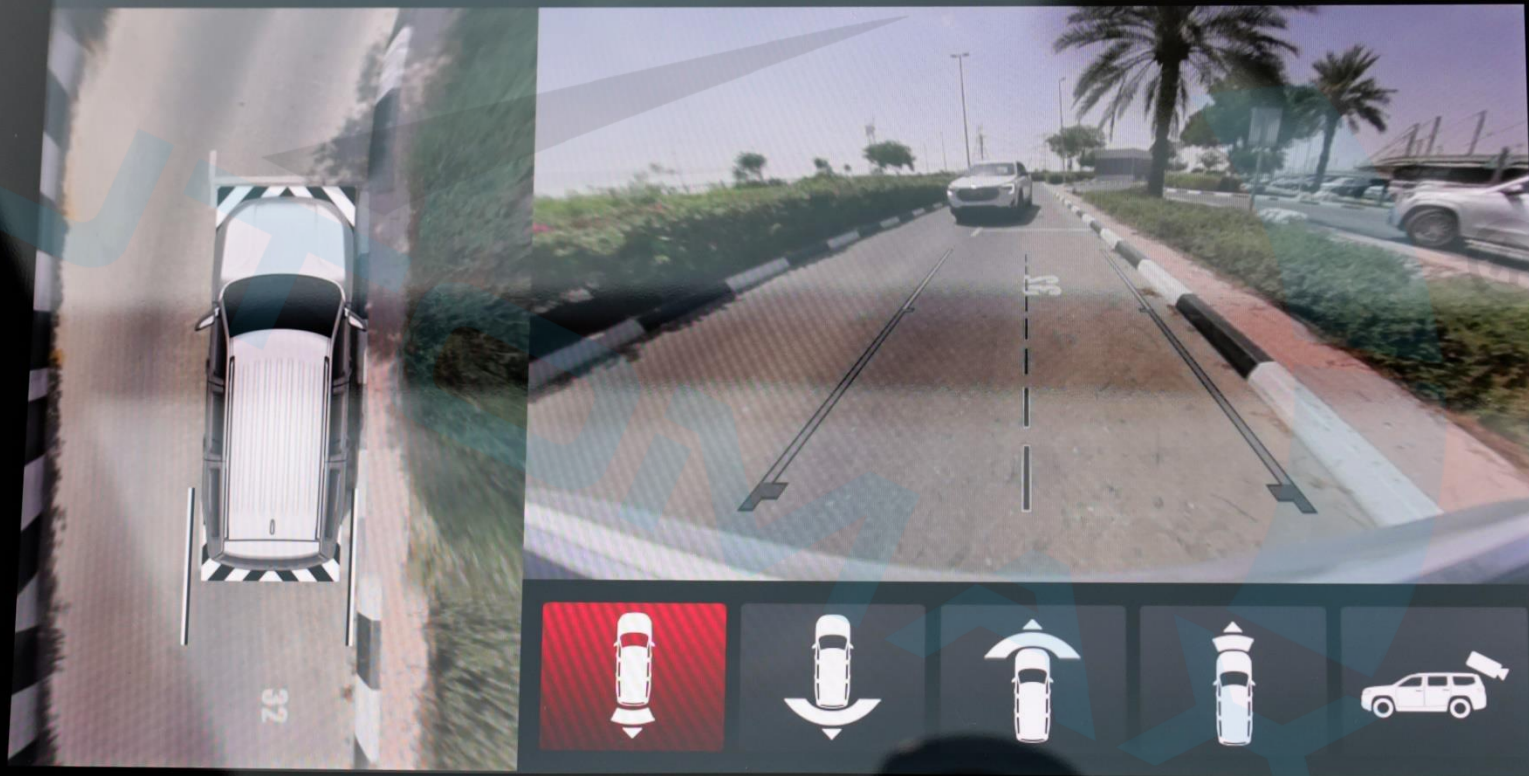

TUNE/  
SCROLL



VOL







اختر مقعد لتغيير تكبير العرض



VOL

TUNE/SCROLL

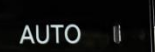

16.0°

Front

Seats

Massage

Rear

Screen Off

16.0°





بحث

12:19

-FM FM

LO

3D

Speaker icon

Menu icon

40

NW

Navigation arrow

Nav

TUNE/SCROLL



VOL



MAX

REAR



OFF

AUTO

A/C





LO

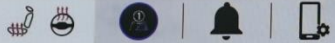

12:14

DUBAI- FM

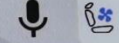

LO

الجميع

المفضلة



تهوية الراكب



تدفئة السائق



تدفئة الراكب



الراحة



مقود مدمأ

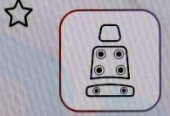

مقاعد التدليك



تهوية السائق

الوسائط

مريح

الملاحة

الهاتف

التطبيقات



NW



TUNE/SCROLL



MAX

REAR



OFF

AUTO

A/C







أراض وعرة

متحكمات

إعدادات

طي مسند  
الرأس للصف  
الثالث 

طي مسند  
الرأس للصف  
الثاني 

معتم المرأة 

Power Side  
Step 

إيقاف  
تشغيل  
شاشة  
الراكب 

شاشة  
الراكب  
مطفأة 

كاميرا الرؤية  
الخلفية 

FamCam 

كاميرا الرؤية  
المحيطية 



NW  
A



TUNE/  
SCROLL





LO



١٢:١٦

DUBAI- FM



LO

ديناميكيات  
المركبة

ملحقات  
المقاييس

انحدار و  
التفاف

Selec-Terrain

نظام التعليق

زاوية التوجيه:  
0°

حالة النقل:  
غير مغلق

قفل المحور  
الخلفي:  
غير مغلق

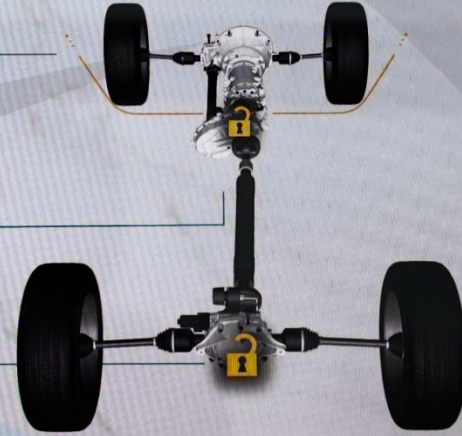

4WD  
HIGH

55°21'60" E

25°10'07" N

ارتفاع 9 m

SPORT



المركبة



NW  
A



AUTO

A/C





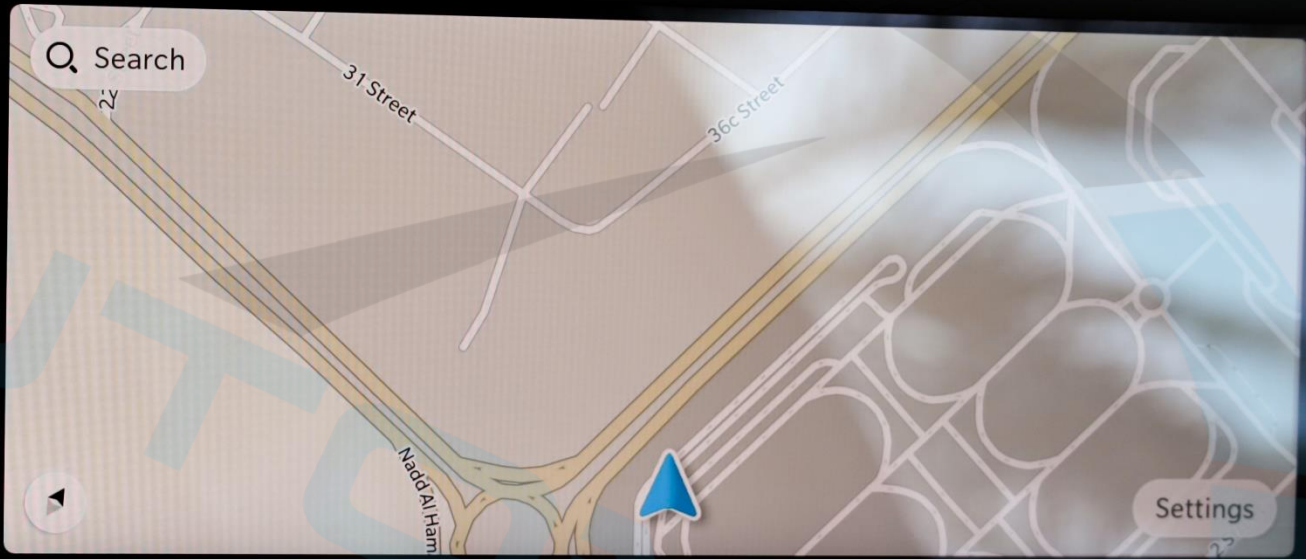

Home

Controls

G R A N D W A G O N E



Home



Controls

### Audio



FM

AM

Bluetooth

More...

### Video



USB 1

USB 2

More...

### HDMI



**HDMI**  
HIGH DEFINITION MULTIMEDIA INTERFACE

Connect HDMI Cable

GRAND WAGON



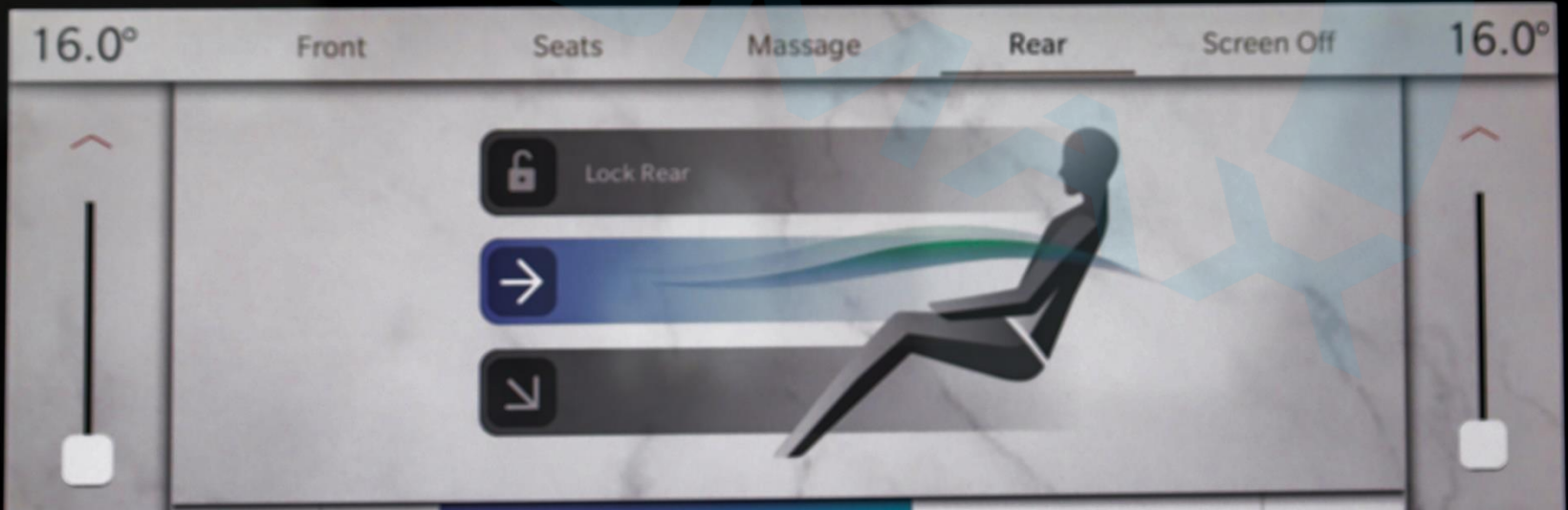
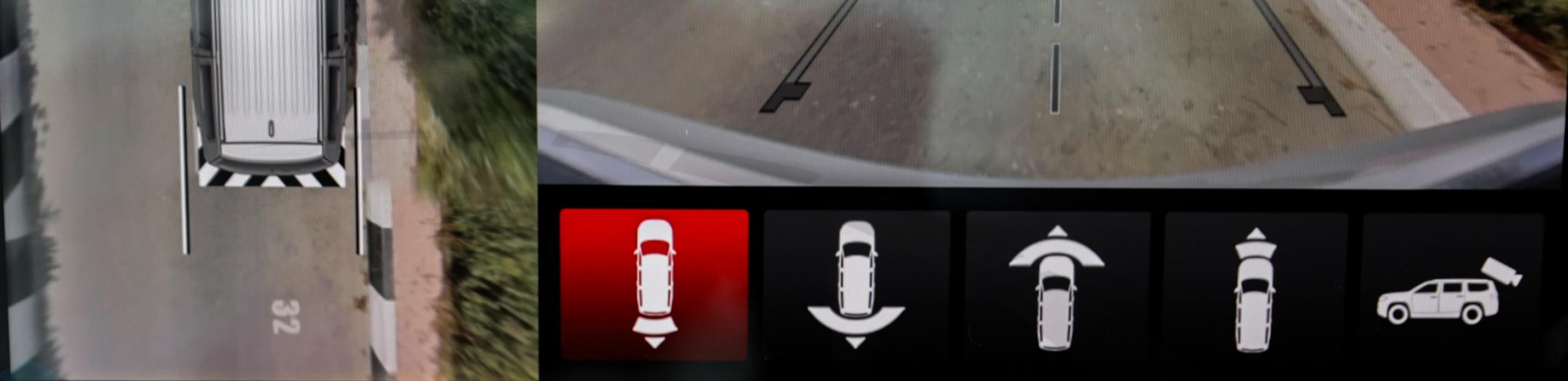





AUTO

A/C



Front      Seats      Massage      Rear      Screen Off

<b>Waterfall</b>	<b>High</b>	<p>Driver</p>	<p>Passenger</p>	<b>High</b>	<b>Waterfall</b>
Lower Back	Med			Med	Lower Back
Extend	Low			Low	Extend
Low Extend	Off			Off	Low Extend
Rock Climb					Rock Climb



MUTE



AUTO HOLD ON



OFF



OFF



ON



OFF



TOW/HAUL ON



OFF

ROCK SAND/AID





AUTO

A/C



Front

Seats

Massage

Rear

Screen Off

Lumbar Up/Down

- +

Lumbar In/Out

- +

Back Bolster

- +

Thigh Bolster

- +



Driver



Passenger

Lumbar Up/Down

- +

Lumbar In/Out

- +

Back Bolster

- +

Thigh Bolster

- +



MUTE



AUTO HOLD ON



OFF



OFF



ON



OFF



TOW/HAUL ON

ROCK SAND/MUD



Extend Low Off Driver Passenger Low Off Extend Low Extend Rock Climb

Driver Passenger

MUTE OFF AUTO HOLD ON OFF OFF ON OFF TOW/HAIL ON

ROCK SAND/MUD SNOW AUTO SPORT

PRND

4WD LOW





MAX REAR AUTO A/C TUNE/SCROLL

Front Seats Massage Rear Screen Off

Waterfall	High	Driver	Passenger	High	Waterfall
Lower Back	Med			Med	Lower Back
Extend	Low			Low	Extend
Low Extend					Low Extend
Rock Climb	Off			Off	Rock Climb

4WD LOW

4WD LOW

4WD LOW





1



AUX



2



HDMI  
PASSENGER









LO

Rear Comfort

Screen Off

16.0°

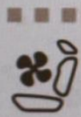
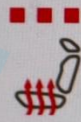
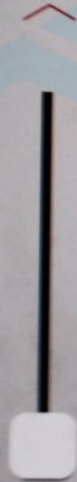

Rear Lock

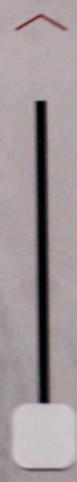
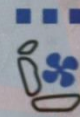
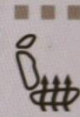
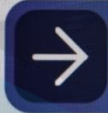

Sync

Off

1

2

3

4



5

6

7

Auto





GRAND WAGON E









































  
2L

  
2R

  
3L

  
3R





12V DC



A horizontal row of controls on a dark leather dashboard. From left to right: a large rotary knob for lighting, two small textured buttons for fog lights, and a rectangular button for wipers. Above the lighting knob is a horizontal grille.

AUTO



PULL ON









پشتیبانی

-

+

1

ADJUST

2





McIntosh

®

PDI - OK  
2013-09-2014













ALUTQZAXX

®







310 SEQ:452970  
S541729 68400498AA





FITOMAXX®



GRAND WAGONEER



















GRAND W









لمشاهدة صورة السيارة بزاوية 360 درجة إضغط على الصورة أعلاه

Для просмотра автомобиля в формате 360°, пожалуйста, нажмите на фото выше.

To view the 360° degree please press on the picture above



# 2023 JEEP GRAND WAGONEER SERIES II 16 3.0L TT 4X4 GCC 0Km

Бренд: Jeep

Brand: Jeep

الماركة: جيب

Категория: GRAND WAGONEER

Category: GRAND WAGONEER

الفئة: GRAND WAGONEER

Модель: SERIES II LUXURY

Model: SERIES II LUXURY

الموديل: SERIES II LUXURY

Год: 2023

Year: 2023

السنة: 2023

Километров: 0 Km

Kilometers: 0 Km

كيلومترات: 0 كم

Двери: 4 Doors

Doors: 4 Doors

عدد الأبواب: 4 أبواب

Цвет: Белый

Color: Bright White

اللون: أبيض

Цилиндр: 6

Cylinder: 6 Cylinders

عدد الأسطوانات: 6 أسطوانات

Лошадиные силы: 510 HP

Horsepower: 510 HP

عدد الأحصنة: 510 حصان

Трансмиссия: Автоматическая

Transmission: Automatic

نوع النقل: نقل أوتوماتيكي

Топливо: Бензин

Fuel: Gasoline

نوع الوقود: بنزين

4X4

4X4

المواصفات خليجية

4X4



# 2023 JEEP GRAND WAGONEER SERIES II 16 3.0L TT 4X4 GCC 0Km

LEATHER TRIMMED BUCKET SEATS  
GLOBAL BLACK  
MIDDLE EAST EQUIPMENT GROUP  
OFF ROAD GROUP II  
FLEXIBLE SEATING GROUP  
AUX BATTERY  
40/20/40 2ND ROW BENCH PWR TIP/SLIDE  
REMOVABLE ASH TRAY  
8 PASSENGER SEATING  
8-SPD AUTO 8HP75 TRANS (BUY-US)  
3.0L 16 HURRICANE HO TWIN TURBO ESS  
AUTO DIM EXTERIOR DRIVER MIRROR  
CIGAR LIGHTER  
GPS NAVIGATION  
GPS ANTENNA INPUT  
ACTIVE NOISE CONTROL SYSTEM  
EXT. MIRRORS W/SUPPLEMENTAL SIGNALS  
EXTERIOR MIRRORS W/ARABIC LETTERING  
EXTERIOR MIRRORS W/MEMORY  
AUTO ADJUST IN REVERSE EXT MIRRORS

HEATED EXTERIOR MIRRORS  
EXTERIOR MIRRORS APPROACH LAMPS  
BLACK ROOF  
QUADRA DRIVE II BADGE  
U.S. EMISSIONS W/OBD I  
INTEGRATED TIRE COMPRESSOR KIT  
BRIGHT WHITE CLEAR COAT  
ALL RADIO EQUIPPED VEHICLES  
12.0" TOUCHSCREEN DISPLAY  
FRONT PASSENGER INTERACTIVE DISPLAY  
2ND ROW DUAL CHG-ONLY USB PORTS  
DIGITAL AUDIO BROADCASTING  
ALL R1 HIGH RADIOS  
BRIDGESTONE BRAND TIRES  
ALL ALUMINUM WHEELS  
FUEL TANK SKID PLATE SHIELD  
TRANSFER CASE SKID PLATE SHIELD  
FRONT AXLE SKID PLATE  
STOP-START DUAL BATTERY SYSTEM  
10 ADDITIONAL GALLONS OF GAS



# 2023 JEEP GRAND WAGONEER SERIES II 16 3.0L TT 4X4 GCS OKm

Quadra Drive II

INTEGRATED TIRE COMPRESSOR KIT

ADJUSTABLE ROOF RAIL CROSSBARS

8 местный

Зимний Пакет

Gear Limit

Вентиляция Сидений

Подогрев Сидений

Сиденья с функцией массажа

Рулевое Колесо с Подогревом

Регулируемые Сиденья с Памятью Позций

Дистанционный Запуск Двигателя

Система Мониторинга Слепых Зон

Бесключевой Доступ

Регулировка Режимов Вождения

Подрулевые Лепестки

Пневмоподвеска

Дистанционное управление пневмоподвеской

Адаптивный Круиз-контроль

ДИСПЛЕЙ ДЛЯ ПАССАЖИРА

Камера Наблюдения Внутри Салона

Холодильник

Контурная Подсветка Салона

Система Экстренного Торможения

Контроль Полосы Движения

Проекция на лобовое стекло

MCINTOSH Премиальная Мультимедийная Система С 19-МИ ДИНАМИКАМИ

Камера 360 Градусов

Панорамная Крыша

Беспроводная Зарядка

Система Помощи При Спуске с Горы

Датчик Давления в Шинах

Розетка

Задние Шторки

Система «Старт-Стоп»

Выдвижная Боковая Подножка

Автопарковка

R 20"

Apple Carplay + Android Auto



# 2023 JEEP GRAND WAGONEER SERIES II 16 3.0L TT 4X4 GCC 0Km

\* الأداء:

ناقل حركة أوتوماتيكي ب 8 سرعات

عدد الأسطوانات: 6 أسطوانات

سعة المحرك: 3.0 توين توربو

العزم: 677 نيوتن.متر

عدد الأحصنة: 510 حصان

دفع رباعي 4X4

\* المواصفات الإضافية:

Quadra Drive II

Gear Limit

INTEGRATED TIRE COMPRESSOR KIT

ADJUSTABLE ROOF RAIL CROSSBARS

8 مراتب

كاميرا بزاوية 360 درجة

شاشة بروجكتر أمامي

شاشة إضافية للمرافق

ثلاجة أمامية

عداد ديجيتال

مثبت السرعة التكميلي

نظام الهيدروليك لرفع و خفض المركبة مع خاصية التحكم عن بعد

نظام صوتي متقدم من MCINTOSH مع 19 سماعة

خاصية التبريد والتدفئة للمراتب

خاصية المساج للمراتب

فتحة سقف بانوراما مزدوجة

خاصية تثبيت المسار

كاميرا داخلية بزاوية 180 درجة

نظام الملاحة وتحديد المواقع



# 2023 JEEP GRAND WAGONEER SERIES II 16 3.0L TT 4X4 GCC 0Km

خاصية الكشف عن النقطة العمياء

أوتو بارك

التشغيل عن بعد

دخول بصمة

خاصية تدفئة المقود

خاصية المساعدة في نزول المنحدرات

نظام البطارية المزدوجة للبدء والتوقف

نظام مكابح متقدم مع الفرامل التلقائية

وضعية قيادة متعددة

مراتب كهربائية متعددة الوضعية مع خاصية الذاكرة

وحدة تكييف خلفية منفصلة

ابل كاربلا

اندرويد أوتو

إنارة داخلية محيطيه

دبّة كهربائية مع حساس قدم

مخارج طاقة كهربائية متعددة

شاحن هاتف لاسلكي

ستائر خلفية

عتبات جانبية كهربائية

جنوط مقاس 20 بوصة



# AUTOMAX®

The Boutique Of Muscle Cars, Truck Fanatics & German Automotive Experts.



نتكلم اللغة العربية

**WE SPEAK ENGLISH**

**ON PARLE LE FRANCAIS**

**Nosotros hablamos español**

мы говорим по-русски

**biz o'zbek tilida**

**gaplashamiz**

हम हिंदी बोलते हैं



**automaxgroup.me**



**automax group**



**automax.dxb**



**Automax\_LLC**



**+971 50 602 7200**



**automax.dxb**



**automax.dxb**



**automax.dxb**



**automax\_dxb**



**automax group L.L.C**

**New Auto Market - Dubai - United Arab Emirates**

 **Directions**