











Jeep

AUTOMAX
AUTOMAX.AE Tel: 04-3205660 / Mob: 05 277 277 01

4x4

LIMITED









Jeep

AIRBAG

Top View

2

1

3

MUTE

MAX

REAR

OFF

1

AUX

2

12V DC



Navigation and lighting control icons: a double-headed arrow, a headlight icon, and up/down arrows.

Steering wheel multifunction controls: a left arrow, an 'OK' button, a right arrow, a left arrow, a downward arrow, a green phone handset icon, a speaker icon, and a red phone handset icon.

Jeep

AIRBAG
R

ep

AG



SET+



CANC



RES



SET-

0 km/h P 88°F

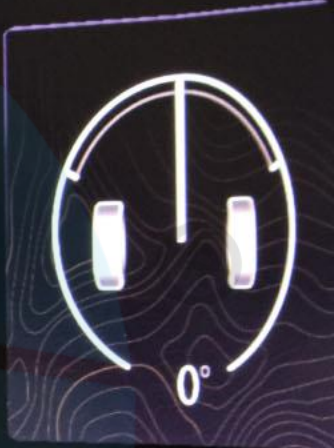
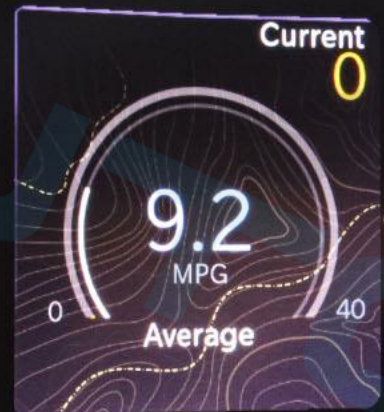
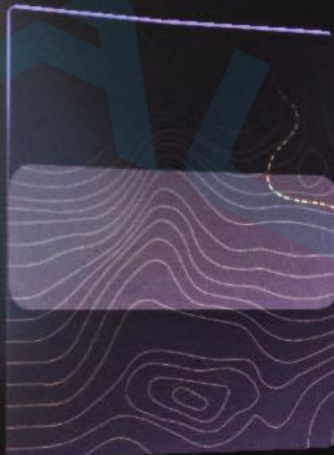

Press OK to Select

Hold OK to Edit

32 km



--

4. Off Road

0 km/h P

88°F

AUTO

Automatic Full
Time 4WD
Adapts to
Road Conditions



RPM X 1000

Terrain Status

32 km

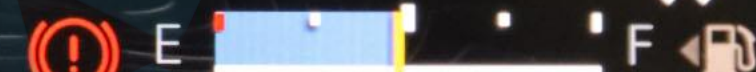

--

4. Off Road

0 km/h P

88°F

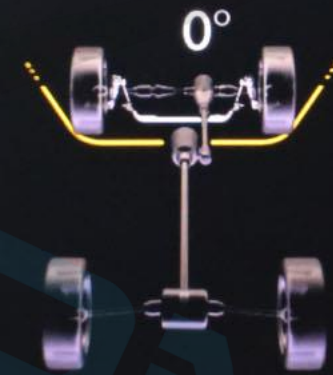

Vehicle Dynamics

32 km

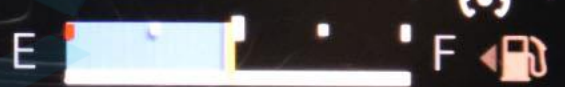
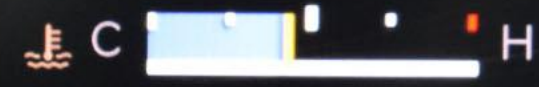

--

4. Off Road

0 km/h P

88°F



3°



0°



RPM X 1000

Pitch & Roll

32 km



E



F





Низ.



98°
НАРУЖН.

4:05

FM STAR FM



Передн.

Задний



Check Entire Surroundings



Top View

Rear View

The main display area is split into two panels. The left panel, labeled 'Top View', shows a top-down perspective of a car on a road. The right panel, labeled 'Rear View', shows a rearward perspective of the same car on a road. Overlaid on both panels are hand gesture icons and numbers: '1' with a hand icon pointing towards the center, '2' with a hand icon pointing towards the top edge, and '3' with a hand icon pointing towards the bottom edge. A white line connects the '2' icons from both panels to a central square icon. Below the main display is a control bar with five icons: a car with a red background, a car with a downward arrow, a car with an upward arrow, a car with a double-headed vertical arrow, and a car with a camera icon.



LO | 36° OUT 4:28 FM ARABIYA | LO

Front Rear

2 2

Heat Heat

Vent Vent

1 1

Max A/C A/C Max Rear

3 3

Sync Off < 1 2 3 4 5 6 7 > Auto

Comfort

MUTE SCREEN OFF

VOL

REAR OFF AUTO

ENTER

LO



36°
OUT

4:37



ARABIYA



LO



Selectable Tire Fill Alert



950



950

950



950

950



950



950

950



Apply and
Save Preset

Presets



E
A



Vehicle



LO



36°
OUT

4:37

FM ARABIYA



LO

Vehicle Dynamics

2



Steering Angle:
0°



2

Accessory Gauges

Transfer Case:
4WD HIGH

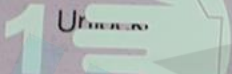

1

Pitch & Roll

Selec-Terrain

Forward Facing Camera

3

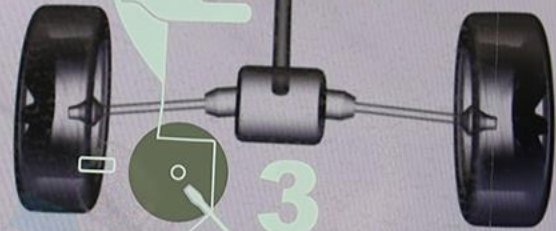

3

4WD HIGH

55°22'03" E

25°10'06" N

Altitude -19 m

AUTO



E



Vehicle



LO



36°
OUT

4:38

FM ARABIYA



LO

Vehicle Dynamics

2

Accessory Gauges

Pitch & Roll

Selec-Terrain

Forward Facing Camera

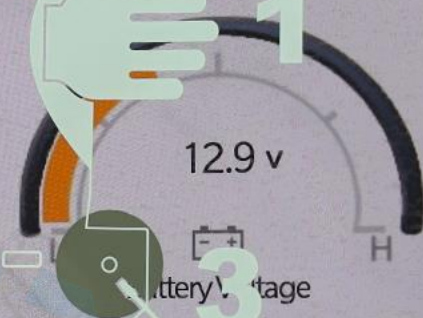
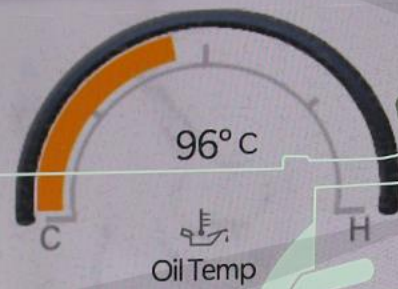

4WD
HIGH

55°22'03" E 25°10'06" N

Altitude -19 m

AUTO



E
A



Vehicle



LO

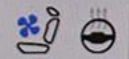

36°
OUT

4:30

FM ARABIYA



LO

Favorites

Recent

Categories

All

2

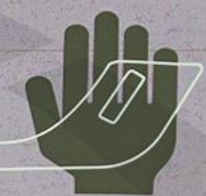
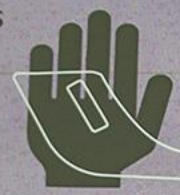

2

eco-Coaching

1



Comfort



Off Road Pages



1

3

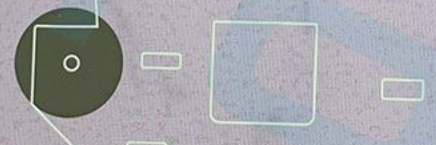

3



E
A



Apps

Vehicle Dynamics

Accessory Gauges

Pitch & Roll

Selec-Terrain

Forward Facing Camera

4WD HIGH 55°22'03" E 25°10'06" N Altitude -19m AUTO

Низ.

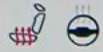

98°
НАРУЖН.

4:04

FM STAR FM



Низ.

Передн.

Задний

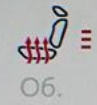

Об.



Вен



Пер. обдув



Об.



Вен

Макс. А/С

A/C

Максим.

Задний

Синхр.

Off



1

2

3

4

5

6

7



Авт.



Главная



M/мед



Comfort



Nav



Тел.



Автом.



Прил.

Последние Категории Все

Vertical menu with icons and a slider:

-
-
-
- Синх.

Main grid of application icons:

- Вент. водит.
- Вент. пасс.
- Допол. кабель
- Камера зад. вида
- Камера круг. обзо...
- Комфорт

Низ.

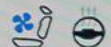

98°
НАРУЖН.

4:01

FM STAR FM



Низ.

Избранные

Последние

Категории

Все

А - Я

Я - А



Автом.



Вент. водит.



Вент. пасс.



Допол.
кабель



Затемнение
зеркала



Камера
зад. вида



Камера
круг. обзо...



Комфорт



Главная



М/мед



Comfort



Nav



Тел.



Автом.



Прил.

Низ.



98°
НАРУЖН.

4:02

FM STAR FM



Низ.

Динамика
автомобиля

Вспомог.
приборы

Попер.
перемещения

Selec-Terrain

Камера
переднего
обзора

Угол поворота
рулевого колеса:
0°

Transfer Case:
Разблокирована

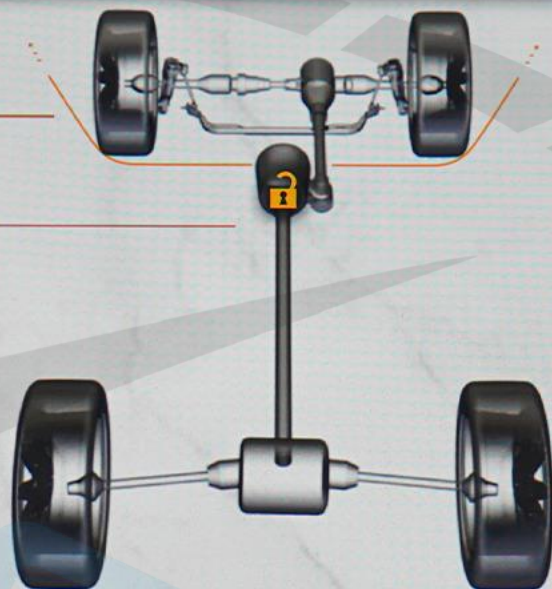

4WD HIGH

55°22'13" E

25°10'20" N

Высота -4 m

SPORT



Главная



М/мед



Comfort



Nav



Тел.



Автом.



Прил.

Низ.



98°
НАРУЖН.

4:02

FM STAR FM



Низ.

Динамика
автомобиля

Вспомог.
приборы

Попер.
перемещения

Selec-Terrain

Камера
переднего
обзора

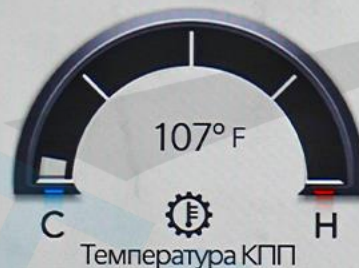

4WD HIGH

55°22'13" E

25°10'20" N

Высота -4 m

SPORT



Главная



М/мед



Comfort



Nav



Тел.



Автом.



Прил.

Низ.



98°
НАРУЖН.

4:02

FM STAR FM



Низ.

Динамика
автомобиля

Вспомог.
приборы

Попер.
перемещения

Selec-Terrain

Камера
переднего
обзора



0°

Наклон

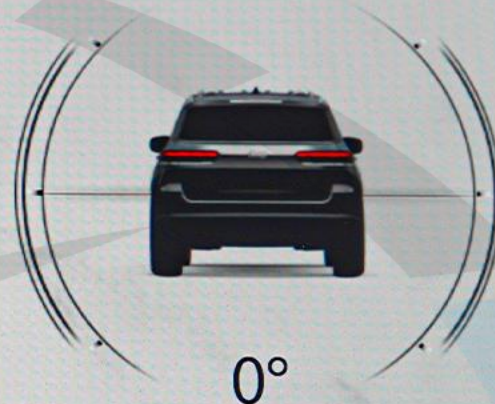

0°

Крен

4WD HIGH

55°22'13" E

25°10'20" N

Высота -4 m

SPORT



Главная



М/мед



Comfort



Nav



Тел.



Автом.



Прил.

Низ.



98°
НАРУЖН.

4:02

FM STAR FM



Низ.

Динамика
автомобиля

Вспомог.
приборы

Попер.
перемещения

Selec-Terrain

Камера
переднего
обзора



4WD HIGH

55°22'13" E

25°10'20" N

Высота -4 m

SPORT



Главная



М/мед



Comfort



Nav



Тел.



Автом.



Прил.

MUTE

OFF

OFF

OFF

OFF

OFF

SCREEN

Низ.

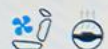

98°
НАРУЖН.

4:02

FM STAR FM



Низ.

Динамика
автомобиля

Вспомог.
приборы

Попер.
перемещения

Selec-Terrain

Камера
переднего
обзора



4WD HIGH

55°22'13" E

25°10'20" N

Высота -4 м

SNOW



Главная



М/мед



Comfort



Nav



Тел.



Автом.



Прил.

MUTE



SCREEN
OFF

Низ.



98°
НАРУЖН.

4:02

FM STAR FM



Низ.

Динамика
автомобиля

Вспомог.
приборы

Попер.
перемещения

Selec-Terrain

Камера
переднего
обзора

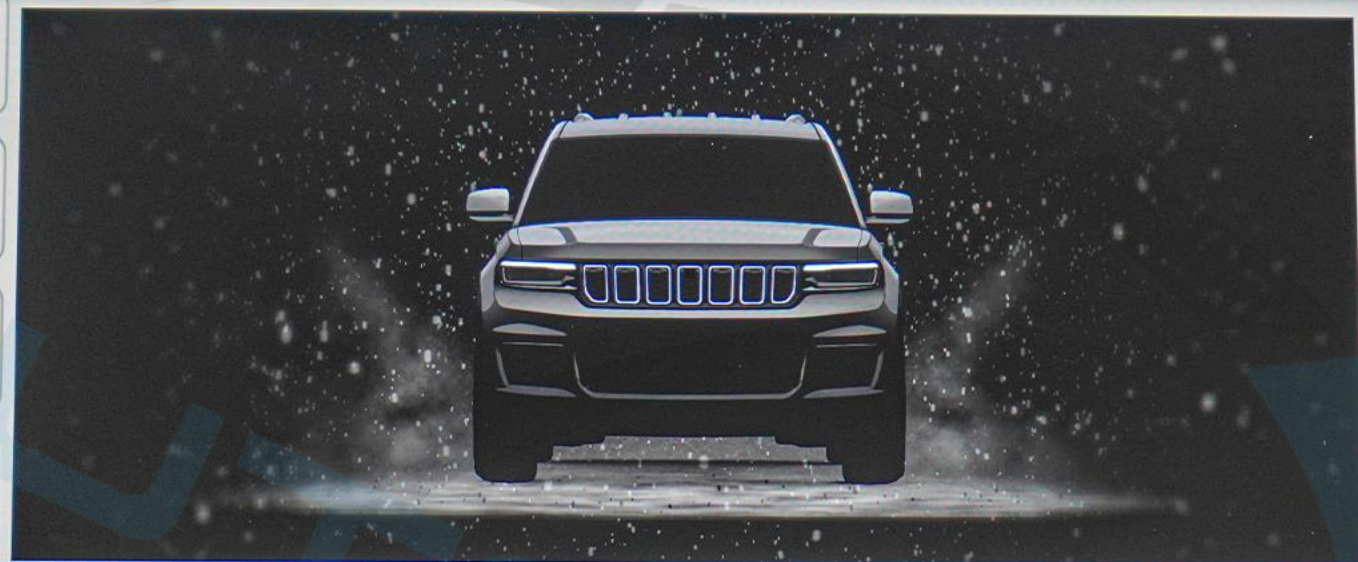

4WD HIGH

55°22'13" E

25°10'20" N

Высота -4 m

SNOW



Главная



М/мед



Comfort



Nav



Тел.



Автом.



Прил.

MUTE



SCREEN
OFF

OFF OFF OFF OFF OFF OFF OFF

22° 24° خارج 7:20 97.30 FM 22°



التطبيقات المركبة الهاتف Nav Comfort الوسائط الرئيسية

MUTE SCREEN OFF



2 غير غير FM

1

4 أنقر للحفظ 3 أنقر للحفظ 2 سر حفظ 1 للحفظ

كل المُسبقة

6 شارع

بحث شارع ند الحمر

1

٢٢° ٢٤° خارج ٦:٢٣ 97.30 FM ٢٢°

ديناميكيات
المركبة

2

زاوية التوجيه
0°

ملحقات
المقاييس

انحدار و
التفاف

Selec-Terrain

الكاميرا الأمامية

4WD
HIGH

55°22'07" E 25°10'14" N ارتفاع -23 m

SNOW

التطبيقات

المركبة

الهاتف

Nav

Comfort

الوسائط

الرئيسية

OFF OFF OFF OFF OFF

٢٢° ٢٤° خارج ٦:٢٣ 97.30 FM ٢٢°

ديناميكيات المركبة

ملحقات المقاييس

انحدار و التفاف

Selec-Terrain

الكاميرا الأمامية



4WD HIGH 55°22'07" E 25°10'14" N ارتفاع -23 m SNOW

التطبيقات

المركبة

الهاتف

Nav

Comfort

الوسائط

الرئيسية

MUTE

SCREEN



22° 24° خارج ٦:٢٣ 97.30 FM 22°

ديناميكيات المركبة 2

ملحقات المقاييس

انحدار و التفاف

Selec-Terrain

الكاميرا الأمامية

انحدار 3

التفاف 3

4WD HIGH 55°22'07" E 25°10'14" N ارتفاع -23 m SNOW

التطبيقات المركبة الهاتف Nav Comfort الوسائط الرئيسية

MUTE SCREEN OFF



Home



Media



Comfort



Nav



Phone



Vehicle



Apps

MUTE



SCREEN OFF

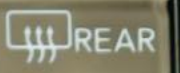

OFF



AUTO

A/C



MAX

REAR

OFF

AUTO

A/C



1



AUX



2



12V DC



SAND/MUD
SNOW
AUTO
SPORT

P R N D

SAND/MUD
SNOW
AUTO
SPORT



P R N D





115 V AC
150 W















ALPINE





12V DC



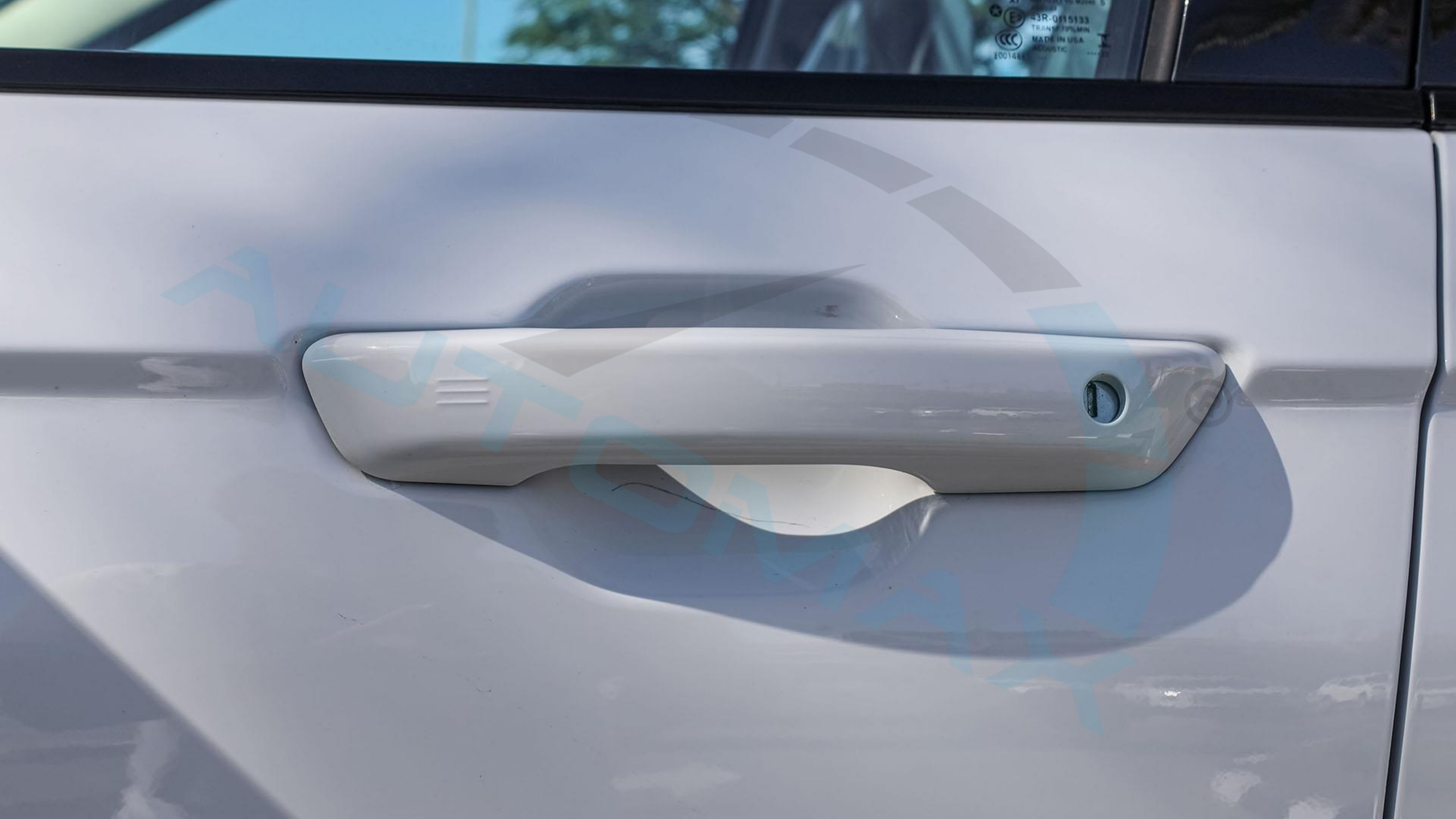

AT
43R-015133
TRANSFORMIN
MADE IN USA
ACOUSTIC
E00148





GRAND CHEROKEE



إسم الصانع والاسم التجاري للمركبة:
FCA US LLC Jeep Grand Cherokee

سنة الموديل: 2023
سعة المحرك: 2.0 L

نوع الدفع: دفع رباعي
نوع الهيكل: سيارة متعددة الأغراض

Drive Line: 4WD
Transmission: Automatic

نوع المركبة: شاحنة خفيفة
Body Style: SUV

Vehicle Type: Light Truck
اقتصاد الوقود (كم/لتر)



نوع الوقود:
بنزين ٩٥

Fuel Type:
Gasoline 95

FE02667/2022



إزالة أو تغطية أو العبث بهذا البطاقة قبل البيع يعرضك للملاحقة القانونية
The removal, covering or damaging of this label before sale is punishable by law

MOPAR
43R-0115133
MADE IN USA





PIRELLI

DOT M11 18 2542

Jeep

SCORPION VERDE

265/55R18





لمشاهدة صورة السيارة بزاوية 360 درجة إضغط على الصورة أعلاه

Для просмотра автомобиля в формате 360°, пожалуйста, нажмите на фото выше.

To view the 360° degree please press on the picture above

2023 JEEP GRAND CHEROKEE LIMITE PLUS LUXURY I4 2.0L TURBO 4X4 GCC 0Km

Бренд: JEEP

Brand: JEEP

الماركة: جيب

Категория: GRAND CHEROKEE

Category: GRAND CHEROKEE

الفئة: جراند شيروكي

Модель: LIMITED PLUS LUXURY

Model: LIMITED PLUS LUXURY

الموديل: ليمتد بلس لكشري

Год: 2023

Year: 2023

السنة: 2023

Километров: 0 км

Kilometers: 0Km

كيلومترات: 0 كم

Двери: 4

Doors: 4 Doors

عدد الأبواب: أربعة ابواب

Цвет: Белый

Color: Bright White

اللون: أبيض

Цилиндр: 4

Cylinder: 4 Cylinders

عدد الاسطوانات: 4 أسطوانات

Лошадиные силы: 270 HP

Horsepower: 270 HP

عدد الأحصنة: 270 حصان

Трансмиссия: Автоматическая

Transmission: Automatic

نوع النقل : نقل أوتوماتيكي

Топливо: Бензин

GCC Specifications

المواصفات الإقليمية: الخليجية

Производство: 2023

Fuel: Gasoline

نوع الوقود: بنزين

2023 JEEP GRAND CHEROKEE LIMITE PLUS LUXURY 14 2.0L TURBO 4X4 GCC 0Km

CAPRI LEATHERETTE W/AXIS II SEATS

GLOBAL BLACK/WICKER BEIGE

MIDDLE EAST EQUIPMENT GROUP

EMEA EQUIPMENT GROUP

LUXURY TECH GROUP II

SMOKER'S GROUP

220 AMP ALTERNATOR

AUX BATTERY

ADVANCED BRAKE ASSIST

ANTI-LOCK 4-WHEEL FNC DISC BRAKES

VENTILATED FRONT SEATS

CARGO COMPARTMENT COVER

REMOVABLE ASH TRAY

8-SPD AUTO 850RE TRANS (MAKE)

3.70 REAR AXLE RATIO

2.0L 14 DOHC DI TURBO ENGINE W/ ESS

LIGHT TINT SOLAR CONTROL GLASS

WINDOW SHADES, 2ND ROW, MANUAL

AUTO DIM EXTERIOR DRIVER MIRROR

RRVIEW AUTODIM DIGITAL DISPLAY MIRRO

DUAL-PANE PANORAMIC SUNROOF

PASSIVE ENTRY-FRT/RR DOORS, LIFTGATE

240 KPH PRIMARY SPEEDOMETER

RAIN SENSITIVE WINDSHIELD WIPERS

REAR BACK UP CAMERA WASHER

CIGAR LIGHTER

GPS NAVIGATION

GPS ANTENNA INPUT

ACTIVE NOISE CONTROL SYSTEM

EXT. MIRRORS W/SUPPLEMENTAL SIGNALS

EXTERIOR MIRRORS W/ARABIC LETTERING

EXTERIOR MIRRORS W/MEMORY

2023 JEEP GRAND CHEROKEE LIMITE PLUS LUXURY 14 2.0L TURBO 4X4 GCC 0Km

MEMORY STEERING COLUMN

HEATED EXTERIOR MIRRORS

GLOSS BLACK EXTERIOR MIRRORS

MANUAL FOLDING EXTERIOR MIRRORS

REAR LED FOG LAMPS

LED DAYTIME RUNNING LAMPS- LOW BEAM

PEDESTRIAN/CYCLIST EMERGENCY BRAKING

FRONT LICENSE PLATE BRACKET

EXPORT EMISSIONS

EURO STAGE 5 EMISSIONS w/EOBD 5

ENGINE OIL COOLER

HEAVY DUTY ENGINE COOLING

BRIGHT WHITE CLEAR COAT

ALL RADIO EQUIPPED VEHICLES

9 AMPLIFIED SPEAKERS w/SUBWOOFER

506 WATT AMPLIFIER

APPLE CARPLAY

DISASSOCIATED TOUCHSCREEN DISPLAY

WIRELESS CHARGING PAD

GOOGLE ANDROID AUTO

USB HOST FLIP

BODY COLOR SHARK FIN ANTENNA

10.1" TOUCHSCREEN DISPLAY

DIGITAL AUDIO BROADCASTING

INTEGRATED CENTER STACK RADIO

ALL R1 HIGH RADIOS

EXPORT TUNED SUSPENSION

POWER TILT/TELESCOPE STEERING COLUMN

FULL SIZE SPARE TIRE

265/50R20 PERFORMANCE A/S TIRES

2023 JEEP GRAND CHEROKEE LIMITE PLUS LUXURY 14 2.0L TURBO 4X4 GCC 0Km

PIRELLI BRAND TIRES

UCONNECT 5 NAV W 10.1" DISP(ROW+DAB)

REST OF WORLD RADIO COUNTRIES

20X8.5 MACHINED/PAINTED ALUM WHEEL

ALL ALUMINUM WHEELS

18" FULL SIZE STEEL SPARE WHEEL

SURROUND VIEW CAMERA SYSTEM

PARKSENSE FR/RR PARK ASSIST W/STOP

ARABIC LANGUAGE

INTEGRATED OFF-ROAD CAMERA

INTERSECTION COLLISION ASSIST SYSTEM

INTEGRATED VOICE COMMAND W/BLUETOOTH

ALL PARKSENSE SYSTEMS

3 ADDITIONAL GALLONS OF GAS



2023 JEEP GRAND CHEROKEE LIMITE PLUS LUXURY 14 2.0L TURBO 4X4 GCS 0Km

EURO 5

Зимний Пакет

Вентиляция и Подогрев Сидений

Рулевое Колесо с Подогревом

Боковые Зеркала с Подогревом

Электрорегулировка сидений с памятью позиций

Адаптивный круиз-контроль

Камера 360 градусов

Регулируемые режимы вождения (включая Зимний режим)

Премиум LED оптика

Панорамная Крыша

Стереосистема Alpine с 9 динамиками и сабвуфером

Система удержания в полосе

Зеркало с камерой заднего вида

Система помощи при спуске

Система экстренного торможения

Система контроля слепых зон

Система Start/Stop

Контроль скорости

Бесключевой доступ

Бесключевой старт

Дистанционный запуск двигателя

10,1-дюймовый сенсорный дисплей

Беспроводная зарядка для телефона

Задние Шторки

Система Мониторинга Слепых Зон

Apple CarPlay

Android Auto

2023 JEEP GRAND CHEROKEE LIMITE PLUS LUXURY 14 2.0L TURBO 4X4 GCC 0Km

* الأداء:

ناقل حركة أوتوماتيكي ب 8 سرعات

عدد الأسطوانات: 4 أسطوانات

سعة المحرك: 2.0 ليتر توربو

العزم: 400 نيوتن.متر

عدد الأحصنة: 270 حصان

دفع رباعي 4X4

* المواصفات الإضافية:

OFF ROAD PAGES

رادار

فتحة سقف بانوراما

مثبت السرعة التكميلي

نظام مكابح متقدم مع الفرامل التلقائية

نظام البطارية المزدوجة للبدء والتوقف

كاميرا بزاوية 360

نظام صوتي متقدم من Alpine

كاميرا المرآة الداخلية

خاصية تبريد وتدفئة المراتب

خاصية تدفئة المقود

خاصية تسخين المرايا الجانبية

2023 JEEP GRAND CHEROKEE LIMITE PLUS LUXURY 14 2.0L TURBO 4X4 GCC 0Km

حساسات متقدمة

التشغيل عن بعد

تثبيت مسار

خاصية تنظيف الكاميرا

الوضعيات المتعددة للقيادة

دخول بصمة

خاصية الكشف عن النقطة العمياء

مراتب كهربائية متعددة الوضعيات مع خاصية الذاكرة

شاشة تعمل باللمس قياس حجم 10.1 بوصة

اللغة عربية

نظام الملاحة وتحديد المواقع

آمر صوتي متكامل مع بلوتوث

دبّة كهرباء

مخارج طاقة كهربائية متعددة

شاحن هاتف لاسلكي امامي

ستائر خلفية

إنارة متقدمة

عازل حراري خارجي للزجاج

عازل للضجيج الخارجي

ابل كاربلاي + اندرويد أوتو

AUTOMAX®

The Boutique Of Muscle Cars, Truck Fanatics & German Automotive Experts.



تتكلم اللغة العربية

WE SPEAK ENGLISH

ON PARLE LE FRANCAIS

Nosotros hablamos español

мы говорим по-русски

biz o'zbek tilida

gaplashamiz

हम हिंदी बोलते हैं



automaxgroup.me



automax group



automax.dxb



Automax_LLC



+971 50 602 7200



automax.dxb



automax.dxb



automax.dxb



automax_dxb



automax group L.L.C

New Auto Market - Dubai - United Arab Emirates

 **Directions**