



GRAND WAGONEER





GRAND WAGONEER

WAGONEER



FERAS RAYO

GRAND WAGONEER

GRAND WAGONEER

AUTOMAX
AUTOMAX LLC 9 9 999 99 99 99



GRAND WAGONEER





GRAND WAGONEER



GRAND WAGONEER



GRAND WAGONEER





GRAND WAGONEER

0 km/h P 26°C
Key Fob
has Left
the Vehicle

DO NOT PRESS

Top View

3

START ENGINE STOP

Front

Lumbar Up/Down
Lumbar In/Out
Back Bolster

GEAR LIMIT



GRAND WAGONEER

AIRBAG
10

GRAND WAGONEER

AIRBAG
10

	SET+	
	CANC	RES
	SET-	

+
GEAR

OFF	ON
REAR	WASHER



0
km/h

ULTONMAXX





1. Driver Info

0

MPH

P

29°C

S



Night Vision



GRAND WAGONER

معلومات السائق 1.

0

MPH

P

29°



Night Vision

61 km

H



C

F

E

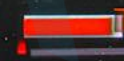

Check entire surroundings



Top View

Rear View



MAX REAR OFF AUTO A/C

Select a seat to change zoom view

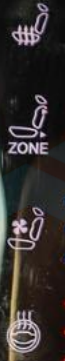

VOL

TUNE/SCROLL



Search



3D
Speaker icon
Menu icon

Home

Media

Comfort

S
A
Nav

Phone

Vehicle

Apps

VOL

TUNE/
SCROLL



Navigation and climate control buttons: Home, MAX, REAR, OFF, AUTO, A/C, and others.

Front Seats Massage Rear

Front Defrost

Heat

Vent

Heat

Vent

Max A/C A/C Max Rear

Sync Off 1 2 3 4 5 6 7 Auto

ZONE

[Icons]

ZONE

[Icons]

VOL

[Knob]

TUNE/SCROLL

[Knob]

LO



3:34

FM STAR FM



LO

Vehicle Dynamics

Steering Angle:
0°

Accessory Gauges

Transfer Case:
Unlocked

Pitch & Roll

Rear Axle Locker:
Unlocked

Selec-Terrain

Suspension

4WD
HIGH

55°22'35" E

25°10'04" N

Altitude -24 m

AUTO

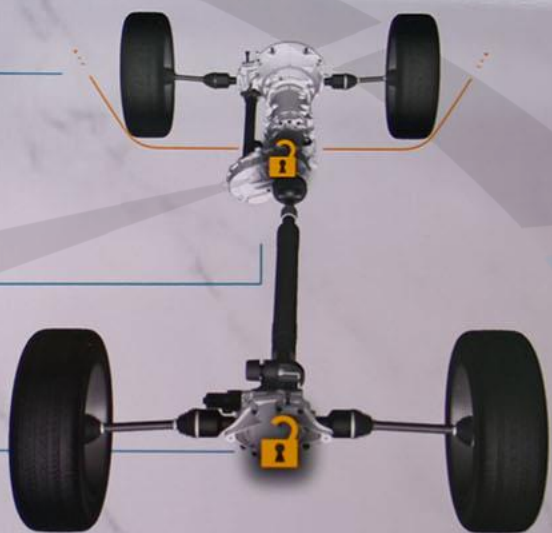

Home



Media



Comfort



Nav



Phone



Vehicle



Apps



TUNE/
SCROLL

Vehicle Dynamics

Accessory Gauges

Pitch & Roll

Selec-Terrain

Suspension

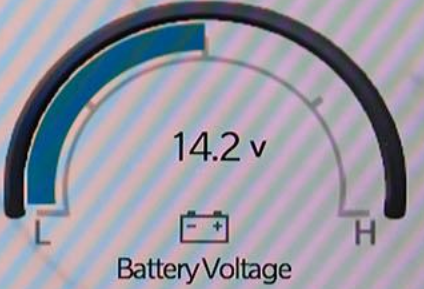

4WD HIGH 55°22'35" E 25°10'04" N Altitude -24 m AUTO

Home

Media

Comfort

Nav

Phone

Vehicle

Apps

TUNE/SCROLL

- Vehicle Dynamics
- Accessory Gauges
- Pitch & Roll**
- Selec-Terrain
- Suspension



Pitch

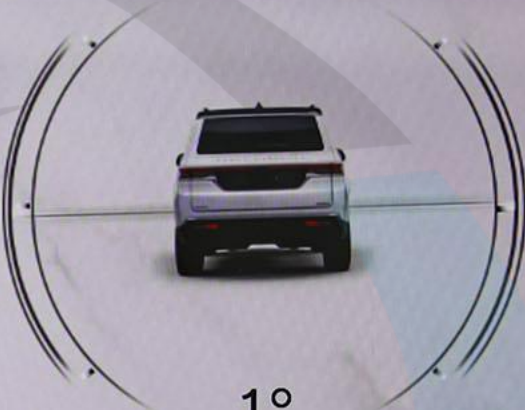

Roll

4WD HIGH 55°22'35" E 25°10'04" N Altitude -24 m AUTO

VOL

TUNE/SCROLL

Vehicle Dynamics

Accessory Gauges

Pitch & Roll

Selec-Terrain

Suspension

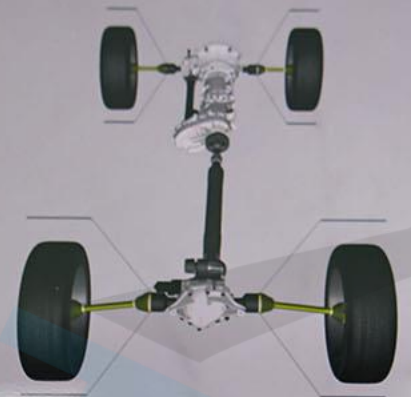

OFF RD 1

4WD HIGH

55°22'35" E

25°10'04" N

Altitude -24 m

AUTO



Home

Media

Comfort

Nav

Phone

Vehicle

Apps



AUTO

A/C



Vehicle Dynamics

Accessory Gauges

Pitch & Roll

Selec-Terrain

Suspension



4WD HIGH 55°22'35" E 25°10'04" N Altitude -24 m AUTO

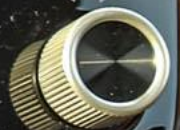

Home



Media



Comfort



Nav



Phone



Vehicle



Apps



AUTO

A/C



McIntosh

REFERENCE

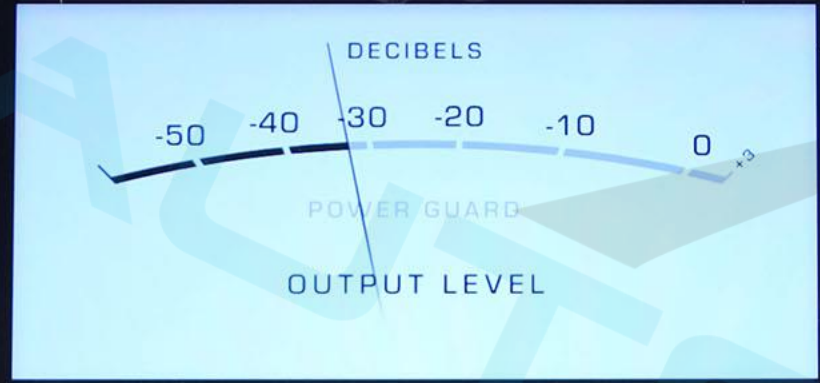

STAR FM

SMS: 3665 Phone: 600551211 twitter: @StarFMUAE insta...
99.9 FM

FM Radio

Audio

◀ CH

CH ▶

VOL

Home

Media

Comfort

Nav

Phone

Vehicle

Apps

TUNE/SCROLL

Favorites Recent Categories All

A-Z Z-A

☆
Tutorials

☆
Uconnect Theater

☆
USB 1

☆
USB 2

☆
Vehicle

☆
2nd Row Headrest...

☆
3rd Row Headrest...

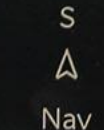

LO

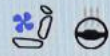

3:37

FM STAR FM



LO

Favorites

Recent

Categories

All

A-Z

Z-A



AM Radio



Ambient Color



Android Auto



Audio Settings



Auxiliary Cable

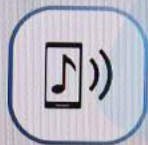

Bluetooth



Comfort

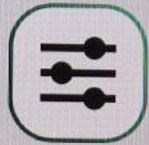

Controls



Home



Media



Comfort



Nav



Phone



Vehicle



Apps



LO



3:37

FM STAR FM

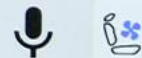

LO

Favorites

Recent

Categories

All

A - Z

Z - A



Tutorials



Uconnect Theater



USB 1



USB 2



Vehicle



2nd Row Headrest...



3rd Row Headrest...



Home



Media



Comfort



Nav



Phone



Vehicle



Apps

MAX

REAR

AUTO

AC

LO



3:37

FM STAR FM



LO



Selectable Tire Fill Alert



65.5



65.5



65.5

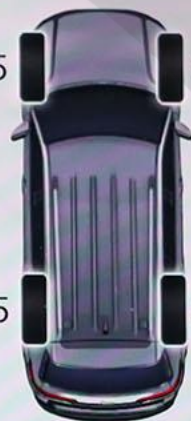

65.5

65.5

65.5

Apply and Save Preset

Presets



Home



Media



Comfort



Nav



Phone



Vehicle



Apps



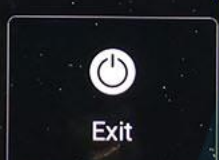
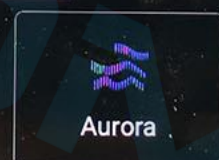
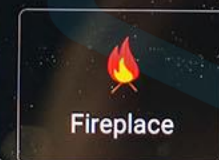
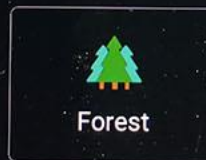
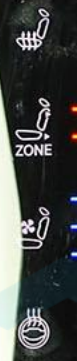

Front Seats Massage Rear Seats Off



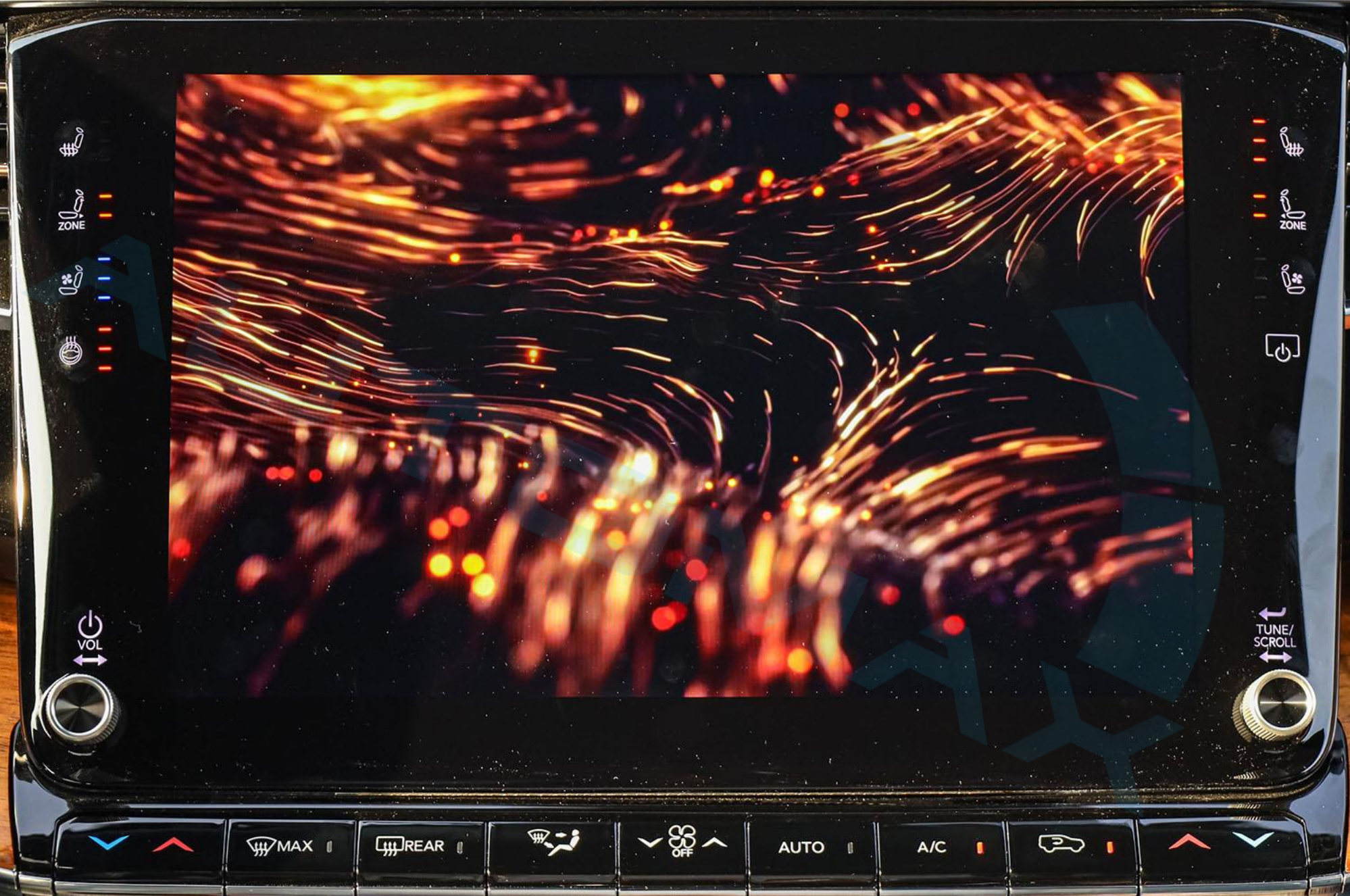

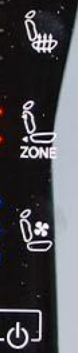

Передн. Сиденья Массаж Задний

Vertical slider with up and down arrows and a central square knob.

Пер. обдув

Об.

Вен

Макс. А/С

A/C

Максим.

Задний

Vertical slider with up and down arrows and a central square knob.

Синхр. Off < 1 2 3 4 5 6 7 > Авт.

Низ.

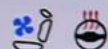

3:43

FM STAR FM



Низ.

Передн.

Сиденья

Массаж

Задний

Расслабл.

Расслабл.

Низ
спины

Гром.

Гром.

Низ
спины

Растягив.

Сред.

Сред.

Растягив.

Низ
растягив.

Низ.

Низ.

Низ
растягив.

Off

Off

Энергичный

Водит.

Пассаж.

Энергичный

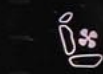

Главная



М/мед



Comfort



Nav



Тел.



Автом.



Прил.



TUNE/
SCROLL

Бездорожье

Элементы управления

Настройки

Затем. зер. зад. вида

Склад. подгол. 2 ряда

Склад. подгол. 3 ряда

Экран пассажира Выкл.

Экран пассажира Питание выкл.

Отказать в выдаче полномочи й экрану

Power Side Step

Кам. круг. обзора

FamCam

Избранные

Последние

Категории

Все



Off Road Pages



Device Manager



Android Auto

VOL



Главная



М/мед



Comfort



Nav



Тел.



Автом.



Прил.

TUNE/SCROLL

Низ.

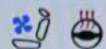

3:42

FM STAR FM



Низ.

Динамика
автомобиля

Вспомог.
приборы

Попер.
перемещения

Selec-Terrain

Подвески

Угол поворота
рулевого колеса:
0°

Раздаточная
коробка:
Разблокирована

Блокиратор
заднего моста:
Разблокирована

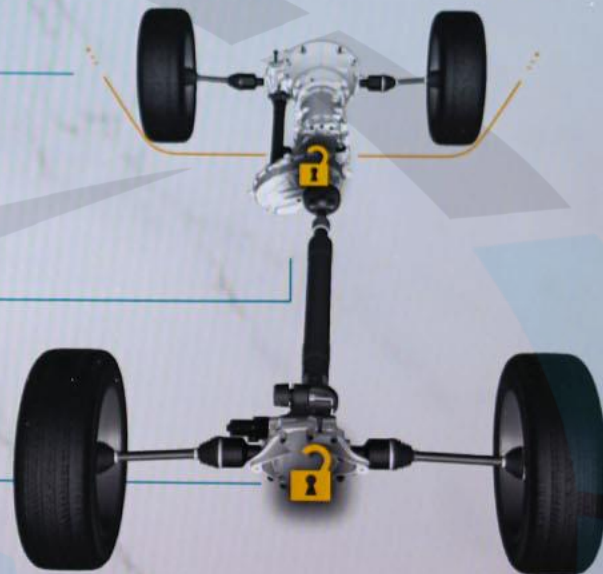

4WD
HIGH

55°22'35" В

25°10'04" С

Высота -24 м

AUTO



Главная



М/мед



Comfort



Nav



Тел.



Автом.



Прил.



TUNE/
SCROLL

Динамика
автомобиля

Вспомог.
приборы

Попер.
перемещения

Selec-Terrain

Подвески



4WD HIGH 55°22'35" В 25°10'04" С Высота -24 m AUTO

VOL

Главная

М/мед

Comfort

Ю А Nav

Тел.

Автом.

Прил.

TUNE/SCROLL

MAX REAR OFF AUTO A/C

Низ.



3:42

FM STAR FM



Низ.

Динамика
автомобиля

Вспомог.
приборы

Попер.
перемещения

Selec-Terrain

Подвески



1°

Наклон



1°

Крен

4WD
HIGH

55°22'35" В

25°10'04" С

Высота -24 м

AUTO



Главная



М/мед



Comfort



Nav



Тел.



Автом.



Прил.

TUNE/
SCROLL



Динамика автомобиля

Вспомог. приборы

Попер. перемещения

Selec-Terrain

Подвески



4WD HIGH 55°22'35" В 25°10'04" С Высота -24 m AUTO

VPL

Главная

М/мед

Comfort

Ю
A
Nav

Тел.

Автом.

Прил.

TUNE/SCROLL

Низ. | 3:42 | FM STAR FM | Низ.

Динамика автомобиля

Вспомог. приборы

Попер. перемещения

Selec-Terrain

Подвески

4WD HIGH 55°22'35" В 25°10'04" С Высота -24 m AUTO

OFF RD 1

VOL

Главная М/мед Comfort Ю А Nav Тел. Автом. Прил.

TUNE/SCROLL

MAX REAR OFF AUTO A/C

Низ.



3:42

FM STAR FM



Низ.

Ambient Color Personalization

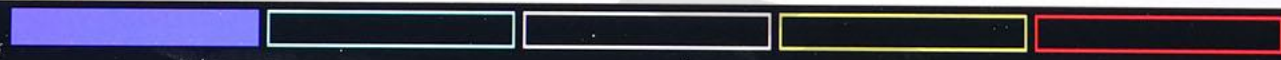

Син.

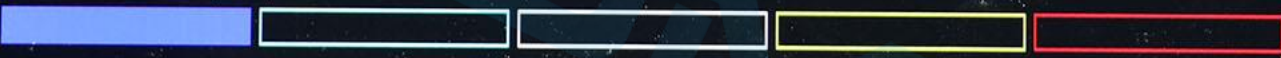

Главная

М/мед

Comfort

Ю
A
Nav

Тел.

Автом.

Прил.



الأمامي المقاعد تدليك خلفي

إزالة الصقيع الأمامي

تسخين مقود التوجيه عالية

تبريد

تسخين تبريد

أقصى تكييف

تكييف الهواء

حد أقصى

خلفي

مزامنة Off < 1 2 3 4 5 6 7 > ألي

مكشوف

ZONE

مكشوف

مكشوف

مكشوف

ZONE

مكشوف

مكشوف

مكشوف

VOL

التطبيقات

المركبة

الهاتف

S A Nav

Comfort

الوسائط

الرئيسية

TUNE/SCROLL

LO



٣:٤١

STAR FM

FM



LO

الأمامي

المقاعد

تدليك

خلفي

الاسترخاء

الاسترخاء

أسفل
الظهر

عالي

عالي

أسفل
الظهر

متوسط

متوسط

تمديد

تمديد

منخفض

منخفض

تمديد أسفل
الظهرتمديد أسفل
الظهر

Off

Off

شديد

شديد



السائق



الراكب



التطبيقات



المركبة



الهاتف

S

Nav



Comfort



الوسائط



الرئيسية

TUNE/
SCROLL

LO



٣:٣٩

STAR FM FM



LO

ديناميكيات
المركبة

ملحقات
المقاييس

انحدار و
التفاف

Selec-Terrain

نظام التعليق

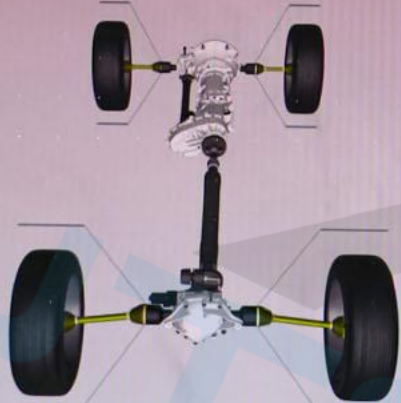

OFF RD 1

4WD
HIGH

55°22'35" E

25°10'04" N

ارتفاع -24m

AUTO

التطبيقات

المركبة

الهاتف

S
A
Nav

Comfort

الوسائط

الرئيسية

TUNE/
SCROLL



LO



٣:٣٩

STAR FM



LO

ديناميكيات
المركبة

ملحقات
المقاييس

انحدار و
التفاف

Selec-Terrain

نظام التعليق



4WD
HIGH

55°22'35" E

25°10'04" N

ارتفاع -24 m

AUTO

التطبيقات

المركبة

الهاتف

Nav

Comfort

الوسائط

الرئيسية

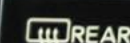
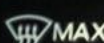

AUTO

A/C

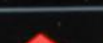
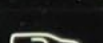

ديناميكيات
المركبة

ملحقات
المقاييس

انحدار و
التفاف

Selec-Terrain

نظام التعليق



1°

انحدار

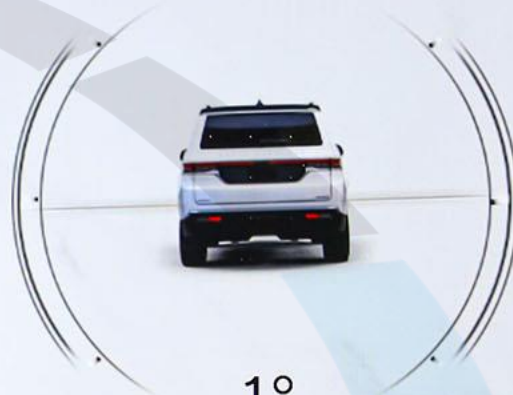

1°

التفاف

4WD
HIGH

55°22'35" E 25°10'04" N

ارتفاع -24 m

AUTO

التطبيقات

المركبة

الهاتف

Nav

Comfort

الوسائط

الرئيسية

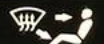

AUTO

A/C



LO



٣:٣٩

STAR FM FM



LO

ديناميكيات
المركبة

ملحقات
المقاييس

انحدار و
التفاف

Selec-Terrain

نظام التعليق

4WD
HIGH

55°22'35" E

25°10'04" N

ارتفاع -24 m

AUTO



VOL



التطبيقات



المركبة



الهاتف



Nav



Comfort



الوسائط



الرئيسية

TUNE/
SCROLL



الجميع الفئات الأخيرة المفضلة

ي-ا ي-ا

☆  طبي مسند رأس... ☆  طبي مسند رأس... ☆  FM راديو	☆  لون المحيط الداخلي ☆  كاميرا الرؤية المحيطة ☆  كاميرا الرؤية الخلفية	☆  AM راديو ☆  AUX كابل
---	---	--

التطبيقات المركبة الهاتف Nav Comfort الوسائط الرئيسية

VOL [Knob]

TUNE/SCROLL [Knob]

MAX REAR OFF AUTO A/C [Icons]

ديناميكيات
المركبة

ملحقات
المقاييس

انحدار و
التفاف

Selec-Terrain

نظام التعليق

زاوية التوجيه:
0°

حالة النقل:
غير مغلق

قفل المحور
الخلفي:
غير مغلق

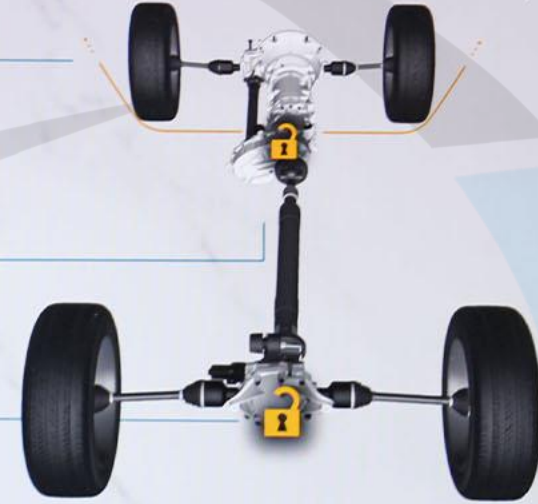

4WD
HIGH

55°22'35" E 25°10'04" N

ارتفاع -24 m

AUTO

VOL



التطبيقات



المركبة



الهاتف



Nav



Comfort



الوسائط



الرئيسية

TUNE/
SCROLL

LO



٣:٣٨

STAR FM FM



LO

أراض وعرة

متحكمات

إعدادات

طي مسند
الرأس للصف
الثالث



طي مسند
الرأس للصف
الثاني



معتم المرأة



منع أذونات
شاشة
الراكب



إيقاف
تشغيل
شاشة
الراكب



شاشة
الراكب
مطفأة



FamCam



كاميرا الرؤية
المحيطة



Power Side
Step



التطبيقات



المركبة

الهاتف

S
A
Nav



Comfort



الوسائط



الرئيسية



VOL



TUNE/
SCROLL



MAX



REAR



OFF



AUTO



A/C



الجميع الفئات الأخيرة المفضلة

ي-١ ي-١

☆ هاتف	☆ ملفات تعريف...	☆ مقود مدفأ	☆ مقاعد التدليك
☆ Device Manager	☆ DAB	☆ Bluetooth	☆ Android Auto

VOL

TUNE/SCROLL

LO



Off Road



Mirror Dimmer

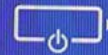

Pass Screen Off

Power Side





|   LO

Settings

rd Row
eadrest
old

eny Pass
creen
ermissions



 ZONE



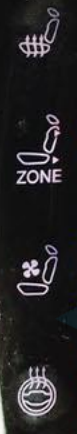
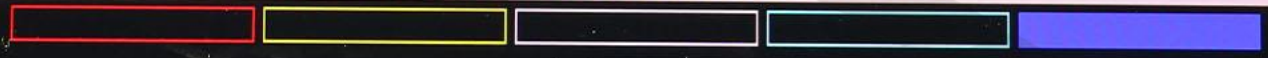

Ambient Color Personalization >

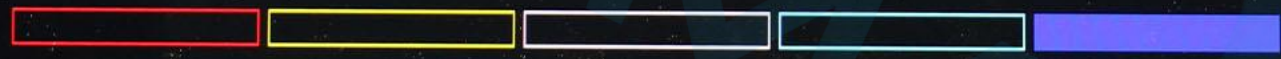

مزامنة



التطبيقات

المركبة

الهاتف

Nav

Comfort

الوسائط

الرئيسية





GRAND WAGON

System



Screen Off



Power Off

Controls

Home



Controls

System



Screen Off



Power Off



Wireless Headphones



Manage Headphone



Mute



Navigation and climate control buttons:

Front Seats | Message | Rear | Screen Off

	Lumbar Up/Down				Lumbar Up/Down		
	Back Bolster				Back Bolster		
	Thigh Bolster				Thigh Bolster		

Driver | Passenger

Drive mode and vehicle control buttons:

ROCK SAND/MUD SNOW AUTO SPORT

PRND

4WD LOW



Front Seats Massage Rear Screen Off



	Lumbar Up/Down			Lumbar Up/Down
	Lumbar In/Out			Lumbar In/Out
	Back Bolster			Back Bolster
	Thigh Bolster			Thigh Bolster

Driver Passenger





Front Seats Massage Rear Screen Off

Waterfall	High			High	Waterfall
Lower Back	Med			Med	Lower Back
Extend	Low			Low	Extend
Low Extend	Off			Off	Low Extend
Rock Climb					Rock Climb

Driver Passenger



ROCK

P R N D



LO Front Seats Massage Rear Screen Off LO

Front Defrost

→

↘

Sync Off 1 2 3 4 5 6 7 Max A/C

A digital climate control interface on a touchscreen. The screen is divided into sections for 'Front', 'Seats', 'Massage', 'Rear', and 'Screen Off'. A central graphic shows a driver's silhouette with blue and green light beams representing airflow. On the left and right sides, there are vertical sliders with red upward and blue downward arrows. At the bottom, there is a row of buttons: 'Sync', 'Off', and a numbered row from 1 to 7, with a fan icon between 5 and 6, and 'Max A/C'.

OFF OFF ON OFF ON



TOW/HAUL ON



P R N D







22.0°

Rear Comfort

Screen Off

22.0°

Control interface for Rear Comfort. It features two vertical sliders on the left and right for temperature adjustment, both currently set to 22.0°. The central area contains a diagram of a person sitting with blue and green airflow lines. Above the diagram is a 'Rear Lock' button with a lock icon. Below the diagram are three directional buttons: a right arrow, a down arrow, and a left arrow. At the bottom, there is a row of buttons: 'Sync', 'Off', '1' (with a flower icon), '2', '3', '4', '5', '6', '7', and 'Auto'.

230 V AC
150 W



12V DC

230 V AC
150 W



12V DC



AIRBAG

GRAND WAGONEER













OFF

ON

OPEN



CLOSE

TILT



DOWN

OPEN



CLOSE

AUTO

VENT

AUTO



UP

(P)68480338AA



®









HOLD
TO SET



AUTO



PULL ON



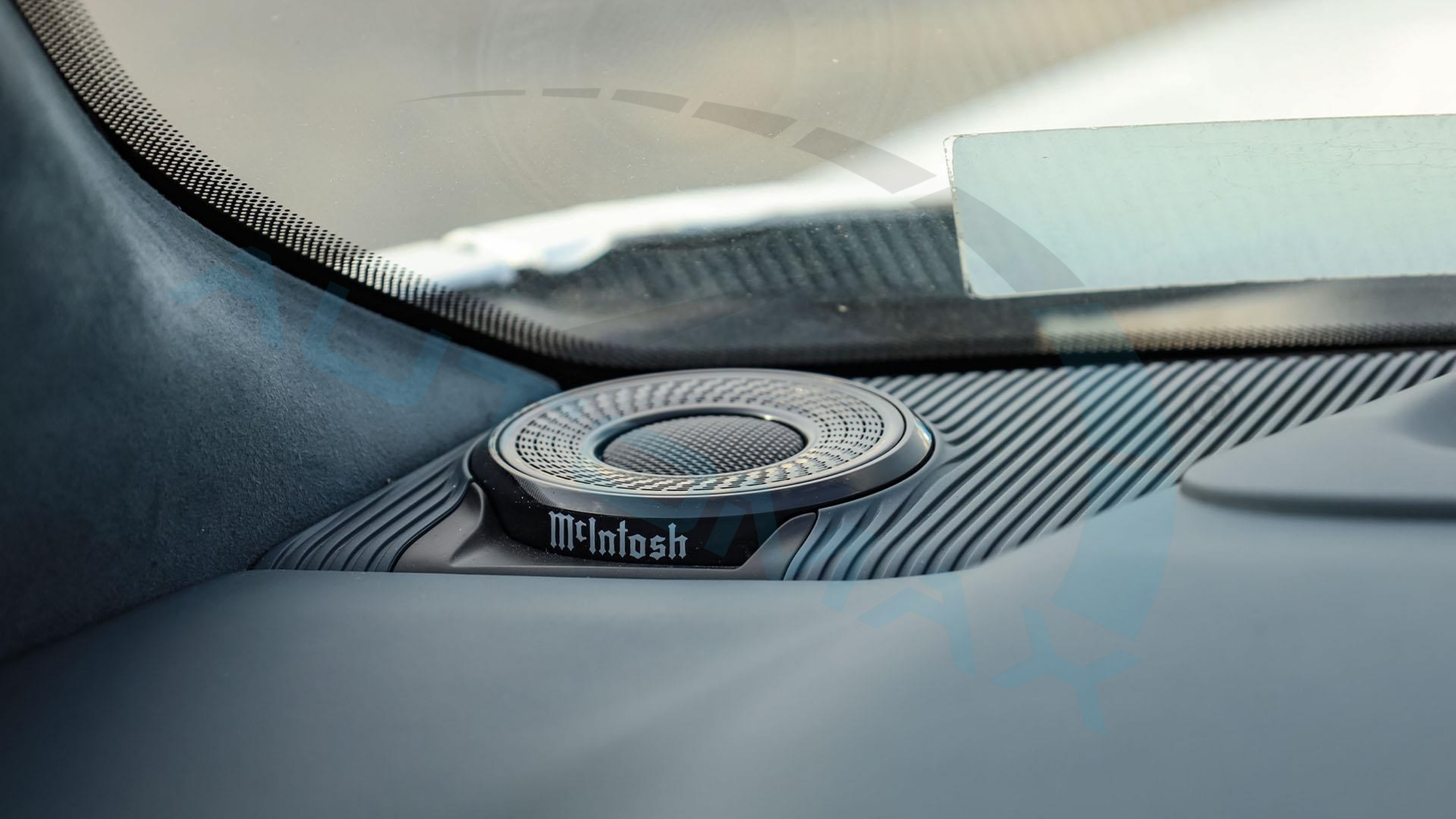

McIntosh





Control panel with buttons and a speaker. The word "ADJUST" is visible on the panel.

Control panel with buttons and a knob. The buttons are labeled "MEMO", "AUTO", and "OFF".

Speaker grille with the McIntosh logo.





McIntosh







GRAND WAGONEER





GRAND WAGONEER



G R

WAGONEER

PIRELLI

SCORPION VERDE

THE ALL-NEW

GRAND WAGONEER

جراند واجونير

الجديدة كليا



AUTOMAXX®



لمشاهدة الفيديو اضغط على الصورة أعلاه

To watch the video please press on the picture above

Для просмотра видео, пожалуйста, нажмите на изображение выше

2023 JEEP GRAND WAGONEER SERIES III 16 3.0L TT 4X4 GCC 0Km

Бренд: Jeep

Brand: Jeep

الماركة: جيب

Категория: GRAND WAGONEER

Category: GRAND WAGONEER

الفئة: GRAND WAGONEER

Модель: SERIES III LUXURY

Model: SERIES III LUXURY

الموديل: SERIES III LUXURY

Год: 2023

Year: 2023

السنة: 2023

Километров: 0 Km

Kilometers: 0 Km

كيلومترات: 0 كم

Двери: 4 Doors

Doors: 4 Doors

عدد الأبواب: 4 أبواب

Цвет: Белый

Color: Bright White / Blue Agave

اللون: أبيض

Цилиндр: 6

Cylinder: 6 Cylinders

عدد الأسطوانات: 6 أسطوانات

Лошадиные силы: 510 HP

Horsepower: 510 HP

عدد الأحصنة: 510 حصان

Трансмиссия: Автоматическая

Transmission: Automatic

نوع النقل: نقل أوتوماتيكي

Топливо: Бензин

Fuel: Gasoline

نوع الوقود: بنزين

4X4

4X4

4X4

GCC

المواصفات خليجية

2023 JEEP GRAND WAGONEER SERIES III 16 3.0L TT 4X4 GCC 0Km

BLACK EDITION

PREM LEATHER TRIMMED BUCKET SEATS

BLUE AGAVE

MIDDLE EAST EQUIPMENT GROUP

TECHNOLOGY GROUP III

FLEXIBLE SEATING GROUP

AUX BATTERY

40/20/40 2ND ROW BENCH PWR TIP/SLIDE

REMOVABLE ASH TRAY

8 PASSENGER SEATING

8-SPD AUTO 8HP75 TRANS (BUY-US)

3.0L 16 HURRICANE HO TWIN TURBO ESS

AUTO DIM EXTERIOR DRIVER MIRROR

CIGAR LIGHTER

130 MPH MAXIMUM SPEED CALIBRATION

GPS NAVIGATION

GPS ANTENNA INPUT

ACTIVE NOISE CONTROL SYSTEM

EXT. MIRRORS W/SUPPLEMENTAL SIGNALS

EXTERIOR MIRRORS W/ARABIC LETTERING

EXTERIOR MIRRORS W/MEMORY

AUTO ADJUST IN REVERSE EXT MIRRORS

HEATED EXTERIOR MIRRORS

EXTERIOR MIRRORS APPROACH LAMPS

BLACK ROOF

QUADRA DRIVE II BADGE

U.S. EMISSIONS W/OBD I

BRIGHT WHITE CLEAR COAT

ALL RADIO EQUIPPED VEHICLES

12.0" TOUCHSCREEN DISPLAY

2ND ROW DUAL CHG-ONLY USB PORTS

DIGITAL AUDIO BROADCASTING

ALL R1 HIGH RADIOS

PIRELLI BRAND TIRES

ALL ALUMINUM WHEELS

STOP-START DUAL BATTERY SYSTEM

ARABIC LANGUAGE

NIGHT VISION/PED-ANIMAL DETECTION

AMAZON FIRE TV BUILT-IN

10 ADDITIONAL GALLONS OF GAS

2023 JEEP GRAND WAGONEER SERIES III 16 3.0L TT 4X4 GCS OKm

Quadra Drive II

BLACK EDITION

8 местный

Зимний Пакет

Gear Limit

Ночное видение

Вентиляция Сидений

Подогрев Сидений

Сиденья с функцией массажа

Рулевое Колесо с Подогревом

Регулируемые Сиденья с Памятью Позичий

Дистанционный Запуск Двигателя

Система Мониторинга Слепых Зон

Бесключевой Доступ

Регулировка Режимов Вождения

режим Зимней Езды

Подрулевые Лепестки

Пневмоподвеска

Дистанционное управление пневмоподвеской

Адаптивный Круиз-контроль

ДИСПЛЕЙ ДЛЯ ПАССАЖИРА

Мультимедийная Система для Пассажигов Заднего Ряда

Камера Наблюдения Внутри Салона

Планшет для задних пассажиров

Ограничитель передач

Холодильник

Контурная Подсветка Салона

Боковые подножки

Система Экстренного Торможения

Контроль Полосы Движения

Ограничитель Скорости

Проекция на лобовое стекло

MCINTOSH Премиальная Мультимедийная Система С

23-МИ ДИНАМИКАМИ

Камера 360 Градусов

Панорамная Крыша

Беспроводная Зарядка

Система Помощи При Спуске с Горы

Датчик Давления в Шинах

Розетка

Задние Шторки

Система «Старт-Стоп»

Выдвижная Боковая Подножка

Автопарковка

Apple Carplay & Android Auto

2023 JEEP GRAND WAGONEER SERIES III 16 3.0L TT 4X4 GCC 0Km

* الأداء:

ناقل حركة أوتوماتيكي ب 8 سرعات

عدد الأسطوانات: 6 أسطوانات

سعة المحرك: 3.0 ليتر

العزم: 677 نيوتن.متر

عدد الأحصنة: 510 حصان

دفع رباعي 4X4

* المواصفات الإضافية:

Quadra Drive II

BLACK EDITION

8 مراتب

نظام الرؤية الليلية NIGHT VISION

كاميرا بزاوية 360 درجة

شاشة بروجكتر أمامي

شاشة إضافية للمرافق

شاشات خلفية

شاشة تحكم بالمقصورة الخلفية

ثلاجة أمامية

مثبت السرعة التكييفي

نظام الهيدروليك لرفع و خفض المركبة مع خاصية التحكم عن بعد

نظام صوتي متقدم من MCINTOSH مع 23 سماعة

خاصية التبريد للمراتب

خاصية التدفئة للمراتب

خاصية المساج المتقدم للمراتب

فتحة سقف بانوراما مزدوجة

2023 JEEP GRAND WAGONEER SERIES III 16 3.0L TT 4X4 GCC 0Km

خاصية الكشف عن النقطة العمياء
أوتوبارك
التشغيل عن بعد
دخول بصمة
عداد ديجيتال
خاصية تدفئة المقود
خاصية المساعدة في نزول المنحدرات
نظام البطارية المزدوجة للبدء والتوقف
كاميرا للمرآة الداخلية
محدد سرعة إلكتروني
نظام مكابح متقدم مع الفرامل التلقائية
الوضعيات المتعددة للقيادة
مراتب متعددة الوضعيات مع خاصية الذاكرة
وحدة تكييف خلفية منفصلة
جهاز تحكم بالشاشات عن بعد

خاصية تثبيت المسار
Gear Limit
كاميرا داخلية بزاوية 180 درجة
نظام الملاحة وتحديد المواقع
ابل كاربلاي لاسلكي
اندرويد أوتو لاسلكي
آمر صوتي متكامل مع بلوتوث
إنارة داخلية محيطيه
خاصية تنظيف الكاميرات
دبّة كهرباء مع حساس قدم
مخارج طاقة كهربائية متعددة
شاحن هاتف لاسلكي
ستائر خلفية
عزل حراري للزجاج الخارجي
عتبات جانبية كهربائية

AUTOMAX®

The Boutique Of Muscle Cars, Truck Fanatics & German Automotive Experts.



تتكلم اللغة العربية

WE SPEAK ENGLISH

ON PARLE LE FRANCAIS

Nosotros hablamos español

мы говорим по-русски

biz o'zbek tilida

gaplashamiz

हम हिंदी बोलते हैं



automaxgroup.me



[automax group](https://www.youtube.com/automaxgroup)



[automax.dxb](https://www.snapchat.com/add/automax.dxb)



[Automax_LLC](https://www.telegram.com/Automax_LLC)



[+971 50 602 7200](https://www.whatsapp.com/+971506027200)



[automax.dxb](https://www.instagram.com/automax.dxb)



[automax.dxb](https://www.facebook.com/automax.dxb)



[automax.dxb](https://www.tiktok.com/automax.dxb)



[automax_dxb](https://www.x.com/automax_dxb)



[automax group L.L.C](https://www.linkedin.com/company/automax-group-l-l-c)

New Auto Market - Dubai - United Arab Emirates

[Directions](#)