





Jeep

AUTOMAX



Jeep

CHEROKEE

AUTOMAX





Jeep

AUTOMAX
AUTOMAX.AE +971 54 279 8899 L +971 4 3200660

4x4

LIMITED



Jeep

AUTOMAX
AUTOMAX

4x4

LIMITED

GRAND CHEROKEE







Jeep

AIRBAG

Top View

2

1

3

MUTE

MAX

REAR

OFF

1

AUX

2

12V DC



Navigation and lighting control icons: a double-headed arrow, a headlight icon, and up/down arrows.

Steering wheel multifunction controls:
Top row: Left arrow, OK button, Right arrow
Middle row: Left arrow, OK button, Right arrow
Bottom row: Downward arrow
Right side buttons: Green phone icon, Media control icon, Red phone icon

Jeep

AIRBAG
R

ep

AG



SET+



CANC



RES



SET-

0 km/h P 88°F

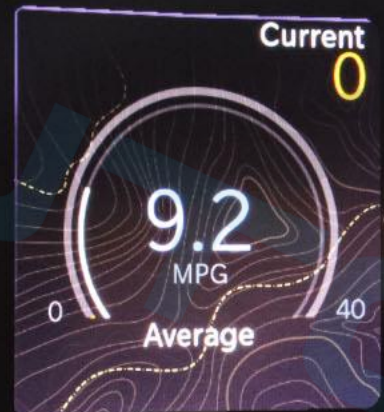
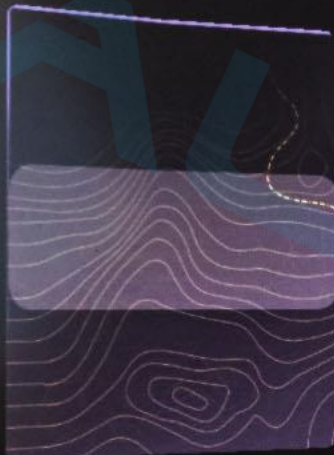

FM 102
FM 102.00 MH

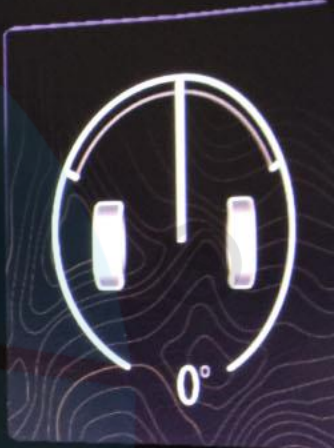

Press OK to Select

Hold OK to Edit

32 km



--

4. Off Road

0 km/h P

88°F

AUTO

Automatic Full

Time 4WD

Adapts to

Road Conditions



RPM X 1000

Terrain Status

32 km

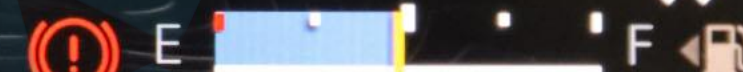

--

4. Off Road

0 km/h P

88°F

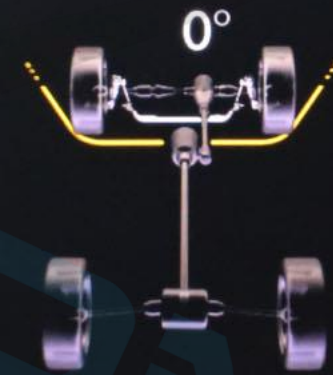

Vehicle Dynamics

32 km

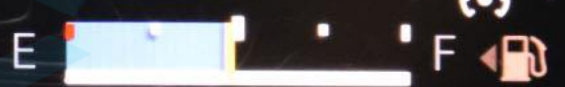



OFF



OFF



OFF

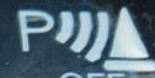

OFF

Низ.



98°
НАРУЖН.

4:05



STAR FM



Передн.

Задний



Check Entire Surroundings



Top View

Rear View

The main display area is split into two panels. The left panel, labeled 'Top View', shows a top-down perspective of a car on a road. The right panel, labeled 'Rear View', shows a rearward perspective of the same car. Hand gesture icons are overlaid on both panels: a hand with index finger pointing up (labeled '1'), a hand with index finger pointing right (labeled '2'), and a hand with index finger pointing down (labeled '3'). A white line connects these gestures between the two views. At the bottom of the main display, there are five icons: a car with a red background and a downward arrow, a car with an upward arrow, a car with an umbrella, a car with a downward arrow, and a car with a camera icon.



LO | | 36° OUT 4:28 FM ARABIYA | LO

Front Rear

2 2

Heat Heat

Vent Vent

1 1

Max A/C A/C Max Rear

3 3

Sync Off < 1 2 3 4 5 6 7 > Auto

MUTE SCREEN OFF

VOL ENTER

REAR OFF AUTO

LO



36°
OUT

4:37

FM ARABIYA



LO

Vehicle Dynamics

2



Steering Angle:
0°



2

Accessory Gauges

Transfer Case:
4WD HIGH



1

Pitch & Roll

Selec-Terrain

Forward Facing Camera

3

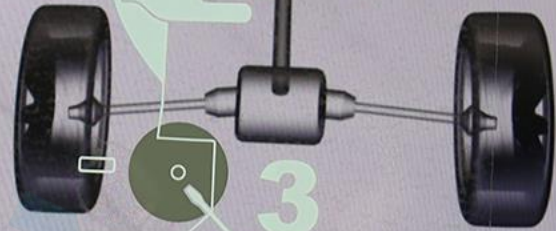

3

4WD HIGH

55°22'03" E

25°10'06" N

Altitude -19 m

AUTO



E



Vehicle



LO



36°
OUT

4:38

FM ARABIYA



LO

Vehicle Dynamics

2

Accessory Gauges

Pitch & Roll

Selec-Terrain

Forward Facing Camera

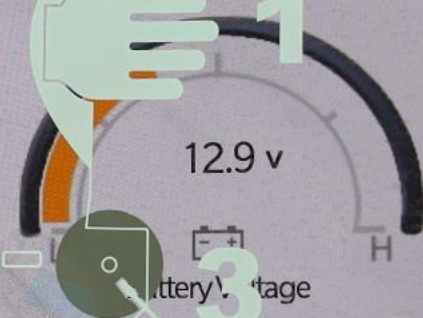
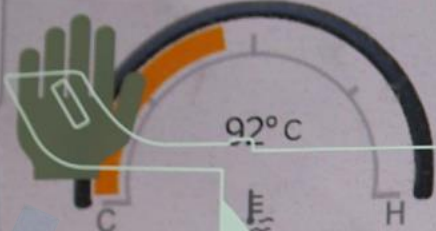

4WD HIGH

55°22'03" E 25°10'06" N

Altitude -19 m

AUTO



E
A



Vehicle



LO

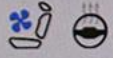

36°
OUT

4:30

FM ARABIYA



LO

Favorites

Recent

Categories

All

2

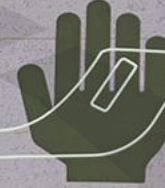

2



eco-
Coaching

1



fort



Off Road
Pages



1

3



3



E
A



Apps

Vehicle Dynamics **2**

Accessory Gauges

Pitch & Roll

Selec-Terrain

Forward Facing Camera

4WD HIGH 55°22'03" E 25°10'06" N Altitude -19m AUTO

Низ.

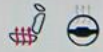

98°
НАРУЖН.

4:04

FM STAR FM



Низ.

Передн.

Задний

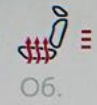

Об.



Вен



Пер. обдув



Об.



Вен

Макс. A/C

A/C

Максим.

Задний

Синхр.

Off



1

2

3

4

5

6

7



Авт.



Главная



M/мед



Comfort



Nav



Тел.



Автом.



Прил.

Последние Категории Все

Vertical menu with icons and a slider:

-
-
-
- Синх.

Main grid of application icons:

- Вент. водит.
- Вент. пасс.
- Допол. кабель
- Камера зад. вида
- Камера круг. обзо...
- Комфорт

Низ.

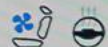

98°
НАРУЖН.

4:01



STAR FM



Низ.

Избранные

Последние

Категории

Все

А - Я

Я - А



Автом.



Вент. водит.



Вент. пасс.



Допол.
кабель



Затемнение
зеркала



Камера
зад. вида



Камера
круг. обзо...



Комфорт



Главная



М/мед



Comfort



Nav



Тел.



Автом.



Прил.

Низ.

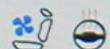

98°
НАРУЖН.

4:02

FM STAR FM



Низ.

Динамика
автомобиля

Вспомог.
приборы

Попер.
перемещения

Selec-Terrain

Камера
переднего
обзора

Угол поворота
рулевого колеса:
0°

Transfer Case:
Разблокирована

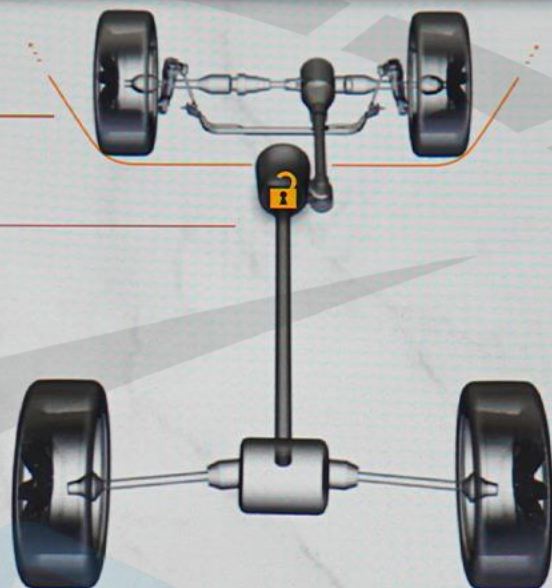

4WD HIGH

55°22'13" E

25°10'20" N

Высота -4 m

SPORT



Главная



М/мед



Comfort



Nav



Тел.



Автом.



Прил.

Низ.



98°
НАРУЖН.

4:02

FM STAR FM



Низ.

Динамика
автомобиля

Вспомог.
приборы

Попер.
перемещения

Selec-Terrain

Камера
переднего
обзора

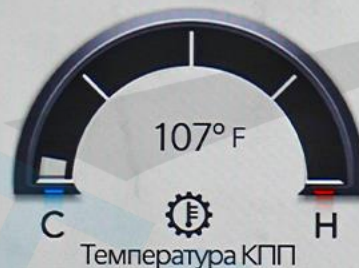

4WD HIGH

55°22'13" E

25°10'20" N

Высота -4 m

SPORT



Главная



М/мед



Comfort



Nav



Тел.



Автом.



Прил.

Низ.



98°
НАРУЖН.

4:02

FM STAR FM



Низ.

Динамика
автомобиля

Вспомог.
приборы

Попер.
перемещения

Selec-Terrain

Камера
переднего
обзора



0°

Наклон

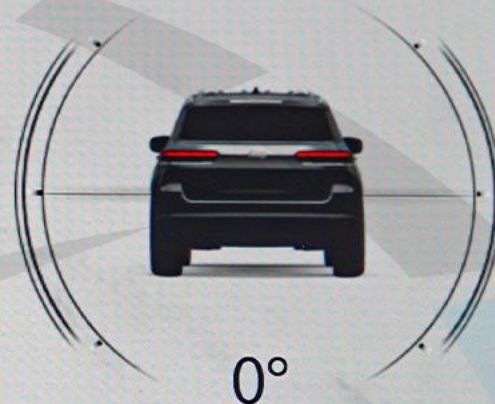

0°

Крен

4WD HIGH

55°22'13" E

25°10'20" N

Высота -4 m

SPORT



Главная



М/мед



Comfort



Nav



Тел.



Автом.



Прил.

Низ.



98°
НАРУЖН.

4:02

FM STAR FM



Низ.

Динамика
автомобиля

Вспомог.
приборы

Попер.
перемещения

Selec-Terrain

Камера
переднего
обзора



4WD HIGH

55°22'13" E

25°10'20" N

Высота -4 m

SPORT



Главная



М/мед



Comfort



Nav



Тел.



Автом.



Прил.

MUTE

OFF

OFF

OFF

OFF

OFF

SCREEN

Низ.

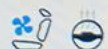

98°
НАРУЖН.

4:02

FM STAR FM



Низ.

Динамика
автомобиля

Вспомог.
приборы

Попер.
перемещения

Selec-Terrain

Камера
переднего
обзора



4WD HIGH

55°22'13" E

25°10'20" N

Высота -4 м

SNOW



Главная



М/мед



Comfort



Nav



Тел.



Автом.



Прил.

MUTE



SCREEN
OFF

Низ.



98°
НАРУЖН.

4:02

FM STAR FM



Низ.

Динамика
автомобиля

Вспомог.
приборы

Попер.
перемещения

Selec-Terrain

Камера
переднего
обзора

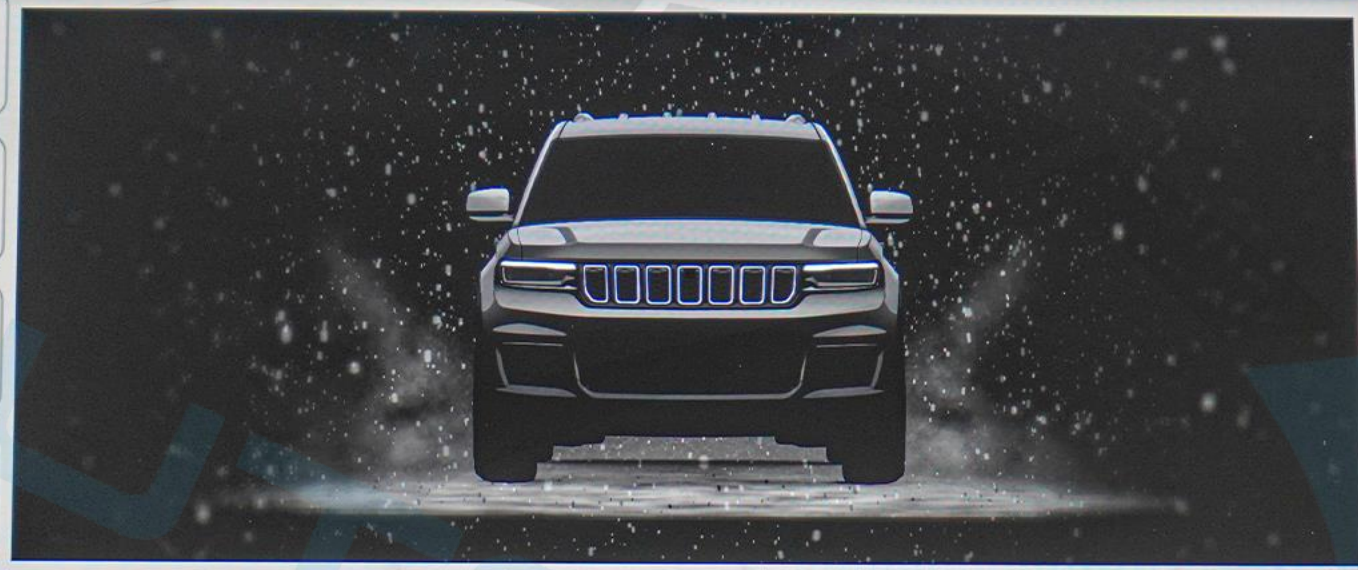

4WD HIGH

55°22'13" E

25°10'20" N

Высота -4 m

SNOW



Главная



М/мед



Comfort



Nav



Тел.



Автом.



Прил.

MUTE



SCREEN
OFF

OFF OFF OFF OFF OFF OFF OFF OFF

22° 24° خارج 7:20 97.30 FM 22°



التطبيقات المركبة الهاتف Nav Comfort الوسائط الرئيسية



MUTE SCREEN OFF



2 غير غير FM

1

4 أنقر للحفظ 3 أنقر للحفظ 2 سر حفظ 1 للحفظ 1 كل المُسبقة

6 شارع 6 شارع 6 شارع

بحث شارع ند الحمر

1

٢٢° ٢٤° خارج ٦:٢٣ 97.30 FM ٢٢°

ديناميكيات
المركبة

2

زاوية التوجيه
0°

ملحقات
المقاييس

انحدار و
التفاف

Selec-Terrain

الكاميرا الأمامية

4WD
HIGH

55°22'07" E 25°10'14" N ارتفاع -23 m

SNOW



التطبيقات



المركبة



الهاتف



Nav



Comfort



الوسائط



الرئيسية

OFF OFF OFF OFF OFF

22° 24° خارج 7:23 97.30 FM 22°

ديناميكيات المركبة

ملحقات المقاييس

انحدار و التفاف

Selec-Terrain

الكاميرا الأمامية



4WD HIGH 55°22'07" E 25°10'14" N ارتفاع -23 m SNOW

التطبيقات

المركبة

الهاتف

Nav

Comfort

الوسائط

الرئيسية

MUTE

SCREEN

OFF OFF OFF OFF OFF OFF

٢٢° ٢٤° خارج ٦:٢٣ 97.30 FM ٢٢°

ديناميكيات المركبة 2

ملحقات المقاييس

انحدار و التفاف

Selec-Terrain

الكاميرا الأمامية

انحدار 3

التفاف 3

4WD HIGH 55°22'07" E 25°10'14" N ارتفاع -23 m SNOW

التطبيقات المركبة الهاتف Nav Comfort الوسائط الرئيسية

MUTE SCREEN OFF



Home



Media



Comfort



Nav



Phone



Vehicle



Apps

MUTE



SCREEN OFF



OFF



AUTO

A/C



MAX

REAR

OFF

AUTO

A/C



12V DC

1

AUX

2



SAND/MUD
SNOW
AUTO
SPORT

P R N D







115 V AC
150 W











Interior control panel featuring a central display area with a car icon, an OFF/ON selector, a red SOS button, and three buttons labeled OPEN/AUTO/CLOSE, TILT/VENT/DOWN, and OPEN/AUTO/CLOSE. The panel is flanked by two illuminated visor lights.

AIRB

Warning label with a red prohibition symbol over a person sitting in a car seat, and a diagram showing a person's head and neck position relative to the seat.









ALPINE





12V DC









TRANSP...
MADE IN USA
USTIC
23...





KUTU DİNKAR

®







GRAND CHEROKEE®

AXXA



LIMITED

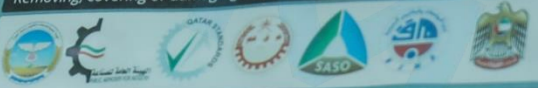

Manufacturer Name FCA US LLC		Label No 158340
Model Year 2024	Vehicle Type FCA US LLC JEEP Grand Cherokee 3.6L SUV 4WD 4Doors	
اقتصاد الوقود Fuel Economy		
12		
Excellent Very Good Good Average Poor Very Poor		
ممتاز جيد جداً جيد متوسط سيء سيء جداً		
 هيئة التقييس اذيان مجلس التعاون لعلوم التقييس العربية GCC Standardisation Organisation	Fuel Type بنزين Gasoline Euro IV	
	Fuel Economy 12 km/L	
	Vehicle Class Light Truck	
إزالة أو تغطية أو إتلاف هذه البطاقة قبل البيع يعرض للملاحقة القانونية Removing, covering or damaging this label before sale is punishable by law		
		







2024 JEEP GRAND CHEROKEE LIMITED PLUS LUXURY GCC 0Km

Бренд: JEEP

Brand: JEEP

الماركة: جيب

Категория: GRAND CHEROKEE

Category: GRAND CHEROKEE

الفئة: جرانند شيروكي

Модель: LIMITED PLUS LUXURY

Model: LIMITED PLUS LUXURY

الموديل: ليمتد بلس لكشري

Год: 2024

Year: 2024

السنة: 2024

Километров: 0 км

Kilometers: 0Km

كيلومترات: 0 كم

Двери: 4

Doors: 4 Doors

عدد الأبواب: أربعة ابواب

Цвет: Серебристый

Color: Silver Zynith

اللون: فضي

Цилиндр: 6

Cylinder: 6 Cylinders

عدد الاسطوانات: 6 أسطوانات

Лошадиные силы: 293 HP

Horsepower: 293 HP

عدد الأحصنة: 293 حصان

Трансмиссия: Автоматическая

Transmission: Automatic

نوع النقل : نقل أوتوماتيكي

Топливо: Бензин

GCC Specifications

المواصفات الإقليمية: الخليجية

Fuel: Gasoline

نوع الوقود: بنزين

2024 JEEP GRAND CHEROKEE LIMITED PLUS LUXURY GCC 0K_m

CAPRI LEATHERETTE W/AXIS II SEATS

GLOBAL BLACK/WICKER BEIGE

MIDDLE EAST EQUIPMENT GROUP

EMEA EQUIPMENT GROUP

LUXURY TECH GROUP II

SMOKER'S GROUP

SIDE STPES

AUX BATTERY

ADVANCED BRAKE ASSIST

ANTI-LOCK 4-WHEEL FNC DISC BRAKES

VENTILATED FRONT SEATS

CARGO COMPARTMENT COVER

REMOVABLE ASH TRAY

8-SPD AUTO 8HP50 TRANS (BUY)

3.6L V6 24V VVT ENGINE UPG I W/ESS

LIGHT TINT SOLAR CONTROL GLASS

WINDOW SHADES, 2ND ROW, MANUAL

AUTO DIM EXTERIOR DRIVER MIRROR

RRVIEW AUTODIM DIGITAL DISPLAY MIRRO

DUAL-PANE PANORAMIC SUNROOF

PASSIVE ENTRY-FRT/RR DOORS, LIFTGATE

240 KPH PRIMARY SPEEDOMETER

RAIN SENSITIVE WINDSHIELD WIPERS

REAR BACK UP CAMERA WASHER

CIGAR LIGHTER

GPS NAVIGATION

GPS ANTENNA INPUT

ACTIVE NOISE CONTROL SYSTEM

EXT. MIRRORS W/SUPPLEMENTAL SIGNALS

EXTERIOR MIRRORS W/ARABIC LETTERING

EXTERIOR MIRRORS W/MEMORY

2024 JEEP GRAND CHEROKEE LIMITED PLUS LUXURY GCC 0K_m

MEMORY STEERING COLUMN

HEATED EXTERIOR MIRRORS

GLOSS BLACK EXTERIOR MIRRORS

MANUAL FOLDING EXTERIOR MIRRORS

REAR LED FOG LAMPS

LED DAYTIME RUNNING LAMPS- LOW BEAM

PEDESTRIAN/CYCLIST EMERGENCY BRAKING

FRONT LICENSE PLATE BRACKET

EXPORT EMISSIONS

EURO STAGE 6B EMISSIONS

ENGINE OIL COOLER

TRANSMISSION HEATER

SILVER ZYNITH

ALL RADIO EQUIPPED VEHICLES

9 AMPLIFIED SPEAKERS w/SUBWOOFER

GLOBAL TELEMATICS BOX MODULE (TBM)

506 WATT AMPLIFIER

APPLE CARPLAY

DISASSOCIATED TOUCHSCREEN DISPLAY

WIRELESS CHARGING PAD

GOOGLE ANDROID AUTO

USB HOST FLIP

BODY COLOR SHARK FIN ANTENNA

10.1" TOUCHSCREEN DISPLAY

DIGITAL AUDIO BROADCASTING

INTEGRATED CENTER STACK RADIO

ALL R1 HIGH RADIOS

EXPORT TUNED SUSPENSION

POWER TILT/TELESCOPE STEERING COLUMN

FULL SIZE SPARE TIRE

2024 JEEP GRAND CHEROKEE LIMITED PLUS LUXURY GCC 0K_m

265/50R20 PERFORMANCE A/S TIRES

PIRELLI BRAND TIRES

UCONNECT 5 NAV W 10.1" DISP(ROW+DAB)

REST OF WORLD RADIO COUNTRIES

20X8.5 MACHINED/PAINTED ALUM WHEEL

ALL ALUMINUM WHEELS

18" FULL SIZE STEEL SPARE WHEEL

SURROUND VIEW CAMERA SYSTEM

NEXT MODEL YEAR VEHICLE TRACKING

PARKSENSE FR/RR PARK ASSIST W/STOP

ARABIC LANGUAGE

INTEGRATED OFF-ROAD CAMERA

INTERSECTION COLLISION ASSIST SYSTEM

INTEGRATED VOICE COMMAND W/BLUETOOTH

MIDEAST EMERGENCY RESPONSE ASSIST

ALL PARKSENSE SYSTEMS

3 ADDITIONAL GALLONS OF GAS



2024 JEEP GRAND CHEROKEE LIMITED PLUS LUXURY GCC 0Km

EURO 6

Зимний Пакет

Вентиляция и Подогрев Сидений

Рулевое Колесо с Подогревом

Боковые Зеркала с Подогревом

Электрорегулировка сидений с памятью позиций

Адаптивный круиз-контроль

Камера 360 градусов

Регулируемые режимы вождения (включая Зимний режим)

Премиум LED оптика

Панорамная Крыша

Стереосистема Alpine с 9 динамиками и сабвуфером

Система удержания в полосе

Зеркало с камерой заднего вида

Система помощи при спуске

Система экстренного торможения

Система контроля слепых зон

Система Start/Stop

Контроль скорости

Бесключевой доступ

Бесключевой старт

Боковые подножки

Дистанционный запуск двигателя

10,1-дюймовый сенсорный дисплей

Беспроводная зарядка для телефона

Задние Шторки

Система Мониторинга Слепых Зон

Apple CarPlay & Android Auto

2024 JEEP GRAND CHEROKEE LIMITED PLUS LUXURY GCC 0Km

* الأداء:

ناقل حركة أوتوماتيكي ب 8 سرعات

عدد الأسطوانات: 6 أسطوانات

سعة المحرك: 3.6 ليتر

العزم: 352 نيوتن.متر

عدد الأحصنة: 293 حصان



دفع رباعي

* المواصفات الإضافية:

OFF ROAD PAGES

رادار

فتحة سقف بانوراما

مثبت السرعة التكميلي

محدد سرعة الكتروني

نظام مكابح متقدم مع الفرامل التلقائية

نظام البطارية المزدوجة للبدء والتوقف

كاميرا بزاوية 360

نظام صوتي متقدم من Alpine

كاميرا المرآة الداخلية

خاصية تبريد وتدفئة المراتب

خاصية تدفئة المقود

خاصية تسخين المرايا الجانبية

2024 JEEP GRAND CHEROKEE LIMITED PLUS LUXURY GCC 0Km

عتبات جانبية
حساسات متقدمة
التشغيل عن بعد
تثبيت مسار
خاصية تنظيف الكاميرا
وضعية قيادة متعددة
دخول بصمة
خاصية الكشف عن النقطة العمياء
مراتب كهربائية متعددة الوضعية مع خاصية الذاكرة
شاشة تعمل باللمس قياس حجم 10.1 بوصة
اللغة عربية

نظام الملاحة وتحديد المواقع
آمر صوتي متكامل مع بلوتوث
دبّة كهرباء
مخارج طاقة كهربائية متعددة
شاحن هاتف لاسلكي امامي
ستائر خلفية
إنارة متقدمة
عازل حراري خارجي للزجاج
عازل للضجيج الخارجي
أبل كاربلاي + أندرويد أوتو

AUTOMAX®

The Boutique Of Muscle Cars, Truck Fanatics & German Automotive Experts.



نتكلم اللغة العربية

WE SPEAK ENGLISH

ON PARLE LE FRANCAIS

Nosotros hablamos español

мы говорим по-русски

biz o'zbek tilida

gaplashamiz

हम हिंदी बोलते हैं



automaxgroup.me



[automax group](https://www.youtube.com/automaxgroup)



[automax.dxb](https://www.snapchat.com/add/automax.dxb)



[Automax_LLC](https://www.telegram.com/Automax_LLC)



[+971 50 602 7200](https://www.whatsapp.com/+971506027200)



[automax.dxb](https://www.instagram.com/automax.dxb)



[automax.dxb](https://www.facebook.com/automax.dxb)



[automax.dxb](https://www.tiktok.com/automax.dxb)



[automax_dxb](https://www.x.com/automax_dxb)



[automax group L.L.C](https://www.linkedin.com/company/automax-group-l-l-c)

New Auto Market - Dubai - United Arab Emirates



Directions