





Jeep

AUTOMAX





GRAND CHEROKEE

Jeep

AUTOMAX

4x4



Jeep

4x4

AUTOMAX
AUTOMAX.AE
+971 44 279 8890
+971 4 3205660

LIMITED









Jeep

AIRBAG

0

P

Key Fob
Has Left
The Vehicle

Top View

Rear View



MUTE

SCREEN OFF

MAX

REAR

OFF

AUTO

A/C

AUX

12V DC

P R N D

SAND/MUD
SNOW
AUTO
SPORT





SET+



CANC



RES



SET-

0 km/h P 88°F

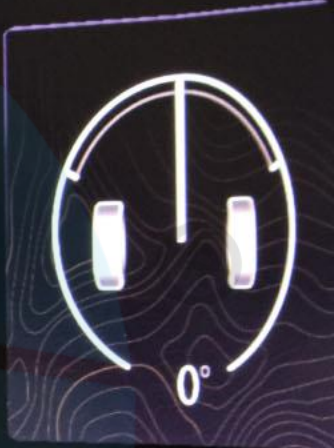
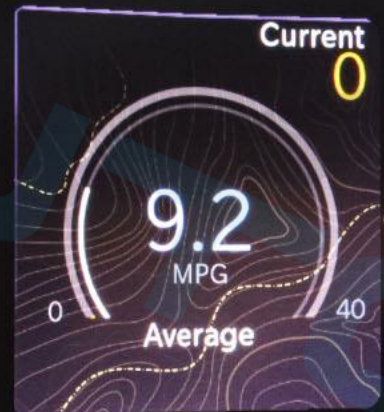
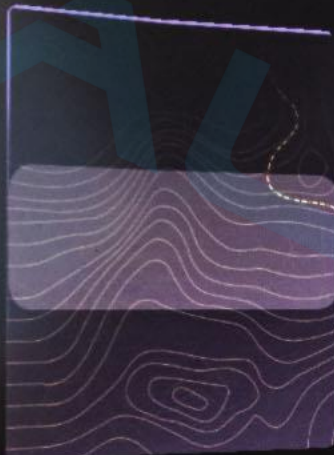

Press OK to Select

Hold OK to Edit

32 km



--

4. Off Road

0 km/h P

88°F

AUTO

Automatic Full

Time 4WD

Adapts to

Road Conditions



RPM X 1000

Terrain Status

32 km



--

4. Off Road

0 km/h P

88°F

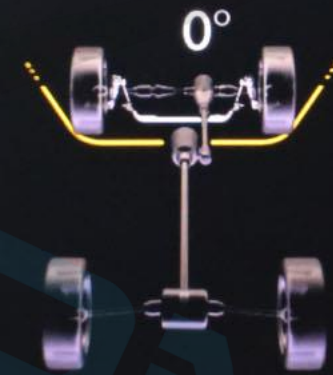

Vehicle Dynamics

32 km

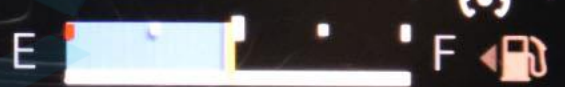
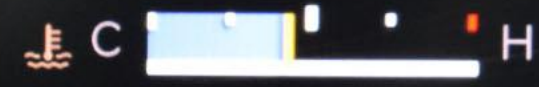

Check Entire Surroundings



Top View

Rear View

The main display area is split into two panels. The left panel, labeled 'Top View', shows a top-down perspective of a car on a road. The right panel, labeled 'Rear View', shows a rear-facing camera view of the road. Hand gesture icons are overlaid on both panels, with numbers 1, 2, and 3 indicating different gestures. In the Top View, gesture 1 is a hand with fingers spread, gesture 2 is a hand with fingers curled, and gesture 3 is a hand with the index finger pointing. In the Rear View, gesture 1 is a hand with fingers spread, gesture 2 is a hand with fingers curled, and gesture 3 is a hand with the index finger pointing. A white arrow points upwards in the center of the Rear View panel. A white box highlights a specific area in the Rear View panel.

-
-
-
-
-

Select a seat to change zoom view



LO | 36° OUT | 4:28 | FM ARABIYA | LO

Front Rear

2 2

Heat Heat

Vent Vent

Max A/C A/C Max Rear

3 3

Sync Off < 1 2 3 4 5 6 7 > Auto



















Comfort

MUTE SCREEN OFF

VOL

REAR OFF AUTO

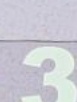
Off Road Controls Settings

  Mirror Dimmer	  3rd Row Headrest Fold	  Surround Camera
  FamCam	  Forward Facing Camera	  Rear View Camera
 	 	 

LO



36°
OUT

4:38

FM ARABIYA



LO

Vehicle Dynamics

2

Accessory Gauges

Pitch & Roll

Selec-Terrain

Forward Facing Camera

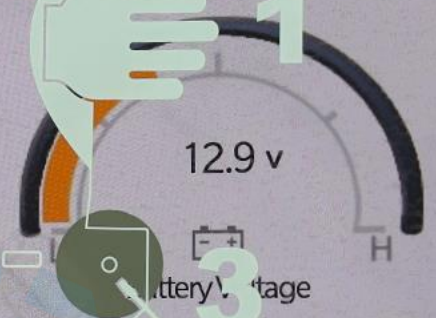
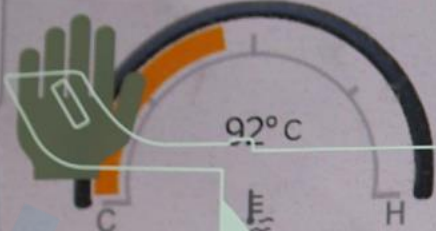

4WD
HIGH

55°22'03" E 25°10'06" N

Altitude -19 m

AUTO



E
A



Vehicle



LO



36°
OUT

4:37

FM ARABIYA



LO

Vehicle Dynamics

2



Steering Angle:
0°



2

Accessory Gauges

Transfer Case:
4WD HIGH

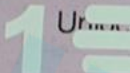

1

Pitch & Roll

Selec-Terrain

Forward Facing Camera

3

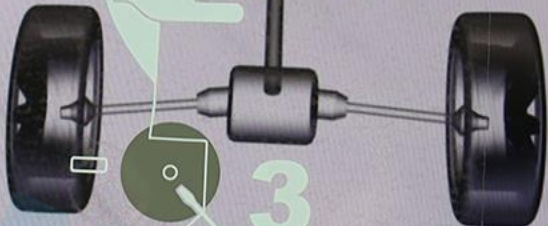

3

4WD HIGH

55°22'03" E

25°10'06" N

Altitude -19 m

AUTO



E
A



Vehicle



LO

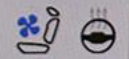

36°
OUT

4:30

FM ARABIYA



LO

Favorites

Recent

Categories

All

2

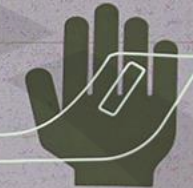
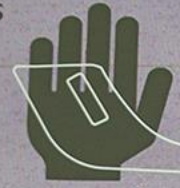

2

eco-Coaching

1



fort



Off Road Pages



1

3

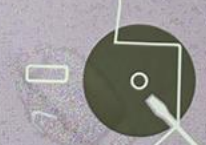

3



Apps

Vehicle Dynamics **2**

Accessory Gauges

Pitch & Roll

Selec-Terrain

Forward Facing Camera

4WD HIGH 55°22'03" E 25°10'06" N Altitude -19 m AUTO

Низ.

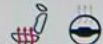

98°
НАРУЖН.

4:04

FM STAR FM



Низ.

Передн.

Задний

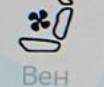

Пер. обдув

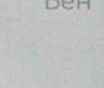

Макс. A/C

A/C

Максим.

Задний

Синхр.

Off



1

2

3

4

5

6

7



Авт.



Главная



M/мед



Comfort



Nav



Тел.



Автом.



Прил.

Последние Категории Все

Vertical menu with icons and a slider:

-
-
-
- Синх.

Main grid of application icons:

- Вент. водит.
- Вент. пасс.
- Допол. кабель
- Камера зад. вида
- Камера круг. обзо...
- Комфорт

Низ.

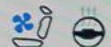

98°
НАРУЖН.

4:01



STAR FM



Низ.

Избранные

Последние

Категории

Все

А - Я

Я - А



Автом.



Вент. водит.



Вент. пасс.



Допол.
кабель



Затемнение
зеркала



Камера
зад. вида



Камера
круг. обзо...



Комфорт



Главная



М/мед



Comfort



Nav



Тел.



Автом.



Прил.

Низ.



98°
НАРУЖН.

4:03

FM STAR FM



Низ.

Бездорожье

Элементы управления

Настройки



Затем. зер.
зад. вида



Склад.
подгол.
3 ряда



Кам. круг.
обзора



FamCam



Камера
передн.
вида



Rear View
Camera



Главная



М/мед



Comfort



Nav



Тел.



Автом.



Прил.

Низ.



98°
НАРУЖН.

4:02

FM STAR FM



Низ.

Динамика
автомобиля

Вспомог.
приборы

Попер.
перемещения

Selec-Terrain

Камера
переднего
обзора

Угол поворота
рулевого колеса:
0°

Transfer Case:
Разблокирована

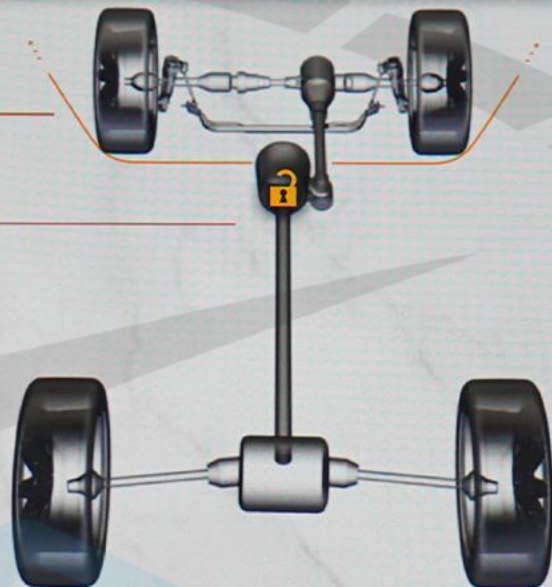

4WD HIGH

55°22'13" E

25°10'20" N

Высота -4 m

SPORT



Главная



М/мед



Comfort



Nav



Тел.



Автом.



Прил.

Низ.



98°
НАРУЖН.

4:02

FM STAR FM



Низ.

Динамика
автомобиля

Вспомог.
приборы

Попер.
перемещения

Selec-Terrain

Камера
переднего
обзора



4WD HIGH

55°22'13" E

25°10'20" N

Высота -4 m

SPORT



Главная



М/мед



Comfort



Nav



Тел.



Автом.



Прил.

Низ.



98°
НАРУЖН.

4:02

FM STAR FM



Низ.

Динамика
автомобиля

Вспомог.
приборы

Попер.
перемещения

Selec-Terrain

Камера
переднего
обзора



0°

Наклон

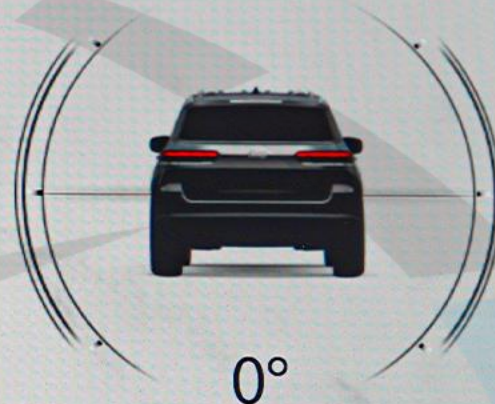

0°

Крен

4WD HIGH

55°22'13" E

25°10'20" N

Высота -4 m

SPORT



Главная



М/мед



Comfort



Nav



Тел.



Автом.



Прил.

Низ.



98°

НАРУЖН.

4:02



STAR FM



Низ.

Динамика
автомобиля

Вспомог.
приборы

Попер.
перемещения

Selec-Terrain

Камера
переднего
обзора



4WD HIGH

55°22'13" E

25°10'20" N

Высота -4 m

SPORT



Главная



М/мед



Comfort



Nav



Тел.



Автом.



Прил.

MUTE

AC

OFF

OFF

OFF

OFF

SCREEN

Низ.

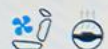

98°
НАРУЖН.

4:02

FM STAR FM



Низ.

Динамика
автомобиля

Вспомог.
приборы

Попер.
перемещения

Selec-Terrain

Камера
переднего
обзора



4WD HIGH

55°22'13" E

25°10'20" N

Высота -4 м

SNOW



Главная



М/мед



Comfort



Nav



Тел.



Автом.



Прил.

MUTE



SCREEN
OFF

OFF OFF OFF OFF OFF OFF OFF OFF

22° 24° خارج 7:20 97.30 FM 22°



التطبيقات المركبة الهاتف Nav Comfort الوسائط الرئيسية

MUTE SCREEN OFF

VOL TIME

أراض وعزم متحكّمات إعدادات

2

كاميرا الرؤية المحيطة

طبي مسند الرأس للصف الثالث

معتم المرآة

1

كاميرا الرؤية الخلفية

الكاميرا الأمامية

amCam

3

MUTE

SCREEN

٢٢° ٢٤° خارج ٦:٢٣ 97.30 FM ٢٢°

ديناميكيات
المركبة

2



زاوية التوجيه
0°

ملحقات
المقاييس

انحدار و
التفاف

Selec-Terrain

الكاميرا الأمامية

حالة المقاييس

1

3

4WD
HIGH

55°22'07" E

25°10'14" N

ارتفاع -23 m

SNOW



التطبيقات



المركبة



الهاتف



Nav



Comfort



الوسائط



الرئيسية

OFF OFF OFF OFF OFF

٢٢° ٢٤° خارج ٦:٢٣ 97.30 FM ٢٢°

ديناميكيات المركبة

ملحقات المقاييس

انحدار و التفاف

Selec-Terrain

الكاميرا الأمامية



4WD HIGH 55°22'07" E 25°10'14" N ارتفاع -23 m SNOW

التطبيقات

المركبة

الهاتف

Nav

Comfort

الوسائط

الرئيسية

MUTE

SCREEN



۲۲° | ۲۴° خارج | ۶:۲۳ | 97.30 FM | ۲۲°

ديناميكيات المركبة 2

ملحقات المقاييس

انحدار و التفاف

Selec-Terrain

الكاميرا الامامية

انحدار 3

التفاف 3

4WD HIGH 55°22'07" E 25°10'14" N ارتفاع -23 m SNOW

التطبيقات | المركبة | الهاتف | Nav | Comfort | الوسائط | الرئيسية

MUTE | SCREEN OFF



Home



Media



Comfort



Nav



Phone



Vehicle



Apps

MUTE



SCREEN OFF



OFF



AUTO

A/C



MAX

REAR

OFF

AUTO

A/C



1



AUX



2



12V DC



SAND/MUD
SNOW
AUTO
SPORT

P R N D







115 V AC
150 W



















////// LPNE















Manufacturer Name		FCA US LLC	اسم المصنع
Model Year	2024	سنة الموديل	
Label No		159451	رقم البطاقة
Vehicle Type		FCA US LLC JEEP Grand Cherokee L 3.6L SUV 4WD 4Doors	نوع المركبة
Fuel Economy		اقتصاد الوقود	
Excellent		ممتاز	
11.7	Very Good	جيد جداً	
	Good	جيد	
	Average	متوسط	
	Poor	سيء	
	Very Poor	سيء جداً	
 هيئة التقييس لمجلس التعاون لول الخليج العربية GCC Standardization Organization	Fuel Type	بنزين	بنزين
	Fuel Economy	11.7 km/L	اقتصاد الوقود
	Vehicle Class	Light Truck	فئة المركبة
إزالة أو تغطية أو إتلاف هذه البطاقة قبل البيع يعرض للملاحقة القانونية Removing, covering or damaging this label before sale is punishable by law			
			





GRAND

265/50 R20

Jeep

H
8

MAXTRACTION





لمشاهدة صورة السيارة بزاوية 360 درجة إضغط على الصورة أعلاه

Для просмотра автомобиля в формате 360°, пожалуйста, нажмите на фото выше.

To view the 360° degree please press on the picture above

2024 JEEP GRAND CHEROKEE L LIMITED PLUS LUXURY GCC 0Km

Бренд: JEEP

Brand: JEEP

الماركة: جيب

Категория: GRAND CHEROKEE L

Category: GRAND CHEROKEE L

الفئة: جرانند شيروكي ال

Модель: LIMITED PLUS LUXURY

Model: LIMITED PLUS LUXURY

الموديل: ليمنند بلس لكشري

Год: 2024

Year: 2024

السنة: 2024

Километров: 0 км

Kilometers: 0Km

كيلومترات: 0 كم

Двери: 4

Doors: 4 Doors

عدد الأبواب: أربعة ابواب

Цвет: Серебристый

Color: Silver Zynith

اللون: فضي

Цилиндр: 6

Cylinder: 6 Cylinders

عدد الاسطوانات: 6 أسطوانات

Лошадиные силы: 293 HP

Horsepower: 293 HP

عدد الأحصنة: 293 حصان

Трансмиссия: Автоматическая

Transmission: Automatic

نوع النقل : نقل أوتوماتيكي

Топливо: Бензин

GCC Specifications

المواصفات خليجية

Fuel: Gasoline

نوع الوقود: بنزين

2024 JEEP GRAND CHEROKEE L LIMITED PLUS LUXURY GCC 0K_m

CAPRI LEATHERETTE W/AXIS II SEATS

GLOBAL BLACK/WICKER BEIGE

MIDDLE EAST EQUIPMENT GROUP

EMEA EQUIPMENT GROUP

LUXURY TECH GROUP II

220 AMP ALTERNATOR

AUX BATTERY

ADVANCED BRAKE ASSIST

SIDE STEPS

ANTI-LOCK 4-WHEEL FNC DISC BRAKES

VENTILATED FRONT SEATS

2ND ROW 60/40 BENCH, MAN TIP/SLIDE

CENTER REAR 3-POINT SEAT BELT

CARGO COMPARTMENT COVER

THREE REAR SEAT HEAD RESTRAINTS

2ND ROW SEAT CTR ARMREST/CUPHOLDERS

7 PASSENGER SEATING

MANUAL FOLD SEATBACKS

8-SPD AUTO 8HP50 TRANS (BUY)

3.6L V6 24V VVT ENGINE UPG I W/ESS

LIGHT TINT SOLAR CONTROL GLASS

WINDOW SHADES, 2ND ROW, MANUAL

AUTO DIM EXTERIOR DRIVER MIRROR

RRVIEW AUTODIM DIGITAL DISPLAY MIRROR

DUAL-PANE PANORAMIC SUNROOF

PASSIVE ENTRY-FRT/RR DOORS, LIFTGATE

240 KPH PRIMARY SPEEDOMETER

RAIN SENSITIVE WINDSHIELD WIPERS

REAR BACK UP CAMERA WASHER

2024 JEEP GRAND CHEROKEE L LIMITED PLUS LUXURY GCC 0K_m

230V/50HZ AUXILIARY POWER OUTLET

GPS NAVIGATION

GPS ANTENNA INPUT

ACTIVE NOISE CONTROL SYSTEM

EXT. MIRRORS w/SUPPLEMENTAL SIGNALS

EXTERIOR MIRRORS w/ARABIC LETTERING

EXTERIOR MIRRORS w/MEMORY

MEMORY STEERING COLUMN

HEATED EXTERIOR MIRRORS

GLOSS BLACK EXTERIOR MIRRORS

MANUAL FOLDING EXTERIOR MIRRORS

REAR LED FOG LAMPS

LED DAYTIME RUNNING LAMPS- LOW BEAM

PEDESTRIAN/CYCLIST EMERGENCY BRAKING

FRONT LICENSE PLATE BRACKET

MOPAR BRIGHT SIDE STEPS

EXPORT EMISSIONS

EURO STAGE 6B EMISSIONS

DUAL EXHAUST TIPS

ENGINE OIL COOLER

TRANSMISSION HEATER

HEAVY DUTY ENGINE COOLING

SILVER ZYNITH

ALL RADIO EQUIPPED VEHICLES

9 AMPLIFIED SPEAKERS w/SUBWOOFER

GLOBAL TELEMATICS BOX MODULE (TBM)

506 WATT AMPLIFIER

APPLE CARPLAY

2024 JEEP GRAND CHEROKEE L LIMITED PLUS LUXURY GCC 0K_m

DISASSOCIATED TOUCHSCREEN DISPLAY

WIRELESS CHARGING PAD

GOOGLE ANDROID AUTO

USB HOST FLIP

BODY COLOR SHARK FIN ANTENNA

10.1" TOUCHSCREEN DISPLAY

DIGITAL AUDIO BROADCASTING

INTEGRATED CENTER STACK RADIO

ALL R1 HIGH RADIOS

EXPORT TUNED SUSPENSION

POWER TILT/TELESCOPE STEERING COLUMN

FULL SIZE SPARE TIRE

265/50R20 PERFORMANCE A/S TIRES

PIRELLI BRAND TIRES

UCONNECT 5 NAV w/ 10.1" DISP (ROW+DAB)

REST OF WORLD RADIO COUNTRIES

20X8.5 MACHINED/PAINTED ALUM WHEEL

ALL ALUMINUM WHEELS

18" FULL SIZE STEEL SPARE WHEEL

SURROUND VIEW CAMERA SYSTEM

PARKSENSE FR/RR PARK ASSIST w/STOP

ARABIC LANGUAGE

INTEGRATED OFF-ROAD CAMERA

INTERIOR REAR FACING CAMERA

INTERSECTION COLLISION ASSIST SYSTEM

INTEGRATED VOICE COMMAND w/BLUETOOTH

MIDEAST EMERGENCY RESPONSE ASSIST

ALL PARKSENSE SYSTEMS

3 ADDITIONAL GALLONS OF GAS

2024 JEEP GRAND CHEROKEE L LIMITED PLUS LUXURY GCC 0Km

EURO 6

7 Сиденья

Зимний Пакет

Вентиляция и Подогрев Сидений

Рулевое Колесо с Подогревом

Боковые Зеркала с Подогревом

Электрорегулировка сидений с памятью позиций

Адаптивный круиз-контроль

Камера 360 градусов

Регулируемые режимы вождения (включая Зимний режим)

Премиум LED оптика

Панорамная Крыша

Стереосистема Alpine с 9 динамиками и сабвуфером

Система удержания в полосе

Зеркало с камерой заднего вида

Система помощи при спуске

Система экстренного торможения

Система контроля слепых зон

Система Start/Stop

Камера Наблюдения Внутри Салона

Кондиционер для пассажиров на заднем ряду

Контроль скорости

Боковые подножки

Бесключевой доступ

Бесключевой старт

Дистанционный запуск двигателя

10,1-дюймовый сенсорный дисплей

Беспроводная зарядка для телефона

Задние Шторки

Apple CarPlay & Android Auto

2024 JEEP GRAND CHEROKEE L LIMITED PLUS LUXURY GCC 0K_m

* الأداء:

ناقل حركة أوتوماتيكي ب 8 سرعات

عدد الأسطوانات: 6 أسطوانات

سعة المحرك: 3.6 ليتر

العزم: 352 نيوتن.متر

عدد الأحصنة: 293 حصان



دفع رباعي

* المواصفات الإضافية:

7 مراتب

OFF ROAD PAGES

رادار

فتحة سقف بانوراما

مثبت السرعة التكييفي

نظام مكابح متقدم مع الفرامل التلقائية

نظام البطارية المزدوجة للبدء والتوقف

كاميرا مراقبة المقصورة

كاميرا بزاوية 360

نظام صوتي متقدم من Alpine

وحدة تكييف خلفية منفصلة

كاميرا المرآة الداخلية

خاصية تبريد وتدفئة المراتب

خاصية تدفئة المقود

خاصية تسخين المرايا الجانبية

2024 JEEP GRAND CHEROKEE L LIMITED PLUS LUXURY GCC 0K_m

عتبات جانبية
حساسات متقدمة
التشغيل عن بعد
تثبيت مسار
خاصية تنظيف الكاميرا
وضعية قيادة متعددة
دخول بصمة
خاصية الكشف عن النقطة العمياء
مراتب كهربائية متعددة الوضعية مع خاصية الذاكرة
شاشة تعمل باللمس قياس حجم 10.1 بوصة
اللغة عربية

نظام الملاحة وتحديد المواقع
آمر صوتي متكامل مع بلوتوث
دبّة كهرباء
مخارج طاقة كهربائية متعددة
شاحن هاتف لاسلكي
ستائر خلفية
إنارة متقدمة
عازل حراري خارجي للزجاج
عازل للضجيج الخارجي
ابل كاربلاي
اندرويد أوتو

AUTOMAX®

The Boutique Of Muscle Cars, Truck Fanatics & German Automotive Experts.



تتکلم اللغة العربية

WE SPEAK ENGLISH

ON PARLE LE FRANCAIS

Nosotros hablamos español

мы говорим по-русски

biz o'zbek tilida

gaplashamiz

हम हिंदी बोलते हैं



automaxgroup.me



automax group



automax.dxb



Automax_LLC



+971 50 602 7200



automax.dxb



automax.dxb



automax.dxb



automax_dxb



automax group L.L.C

New Auto Market - Dubai - United Arab Emirates

 **Directions**