









GRAND CHEROKEE

Jeep

AUTOMAX  
AUTOMAX.COM

4x4

LIMITED



Jeep

**AUTOMAX**  
AUTOMAX.AE ©+971 54 279 8800 ☎+971 4 3205660

4x4

LIMITED











Jeep

AIRBAG

Top View

2

1

3

MUTE

MAX

REAR

OFF

1

AUX

2

12V DC



Navigation and media control icons: a left arrow, a menu icon, an up arrow, and a down arrow.

Steering wheel multifunction controls:  
Top row: Left arrow, OK button, Right arrow  
Middle row: Left arrow, OK button, Right arrow  
Bottom row: Downward arrow  
Right side buttons: Green telephone handset icon, Speaker icon, Red telephone handset icon

Jeep

AIRBAG  
R

ep

AG



SET+



CANC



RES



SET-

N

0 km/h P

92°F

Key Fob  
has Left  
the Vehicle



C



H

27 km

E

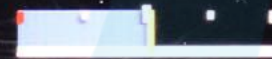

F



0 km/h P 88°F

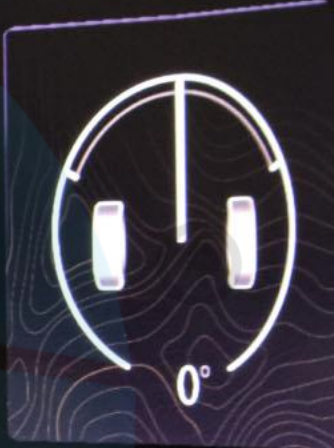
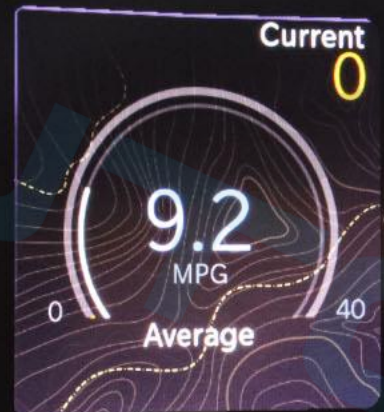
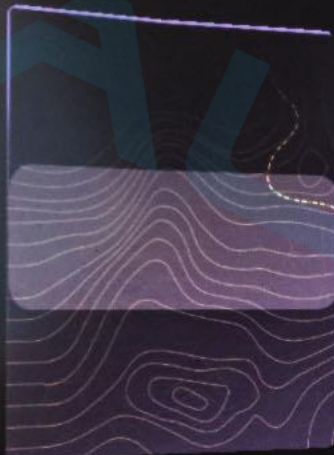

Press OK to Select

Hold OK to Edit

32 km

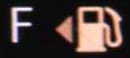

--

4. Off Road

0 km/h P

88°F

AUTO

Automatic Full  
Time 4WD  
Adapts to  
Road Conditions



Terrain Status

32 km



--

4. Off Road

0 km/h P

88°F

**AUTO**

Automatic Full

Time 4WD

Adapts to  
Road Conditions



**Terrain Status**

32 km



--

4. Off Road

0 km/h P

88°F

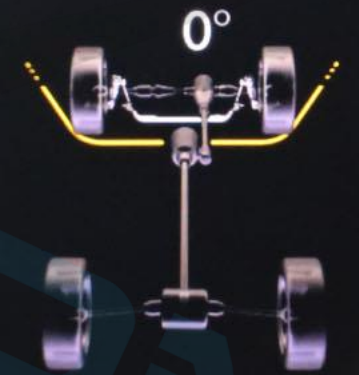

Vehicle Dynamics  
32 km

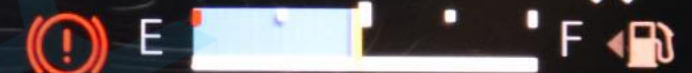



--

4. Off Road

0

km/h

P

88°F



3°



0°



RPM X 1000

Pitch & Roll

32 km



C

H



E

F



4. Off Road

0 km/h P



3°



0°



RPM X 1000

Pitch & Roll

32 km



E





OFF



OFF



OFF



OFF

Низ.



98°  
НАРУЖН.

4:05

FM STAR FM



Передн.

Задний



# Check Entire Surroundings



Top View

Rear View

The main display area is split into two panels. The left panel, labeled 'Top View', shows a top-down perspective of a car on a road. The right panel, labeled 'Rear View', shows a rearward perspective of the same car. Overlaid on these views are hand gesture icons and numbers: '1' for a palm-forward gesture, '2' for a palm-up gesture, and '3' for a circular gesture. A white line connects the '2' gestures in both views. A white arrow points upwards in the rear view. At the bottom of the main display area, there are five icons: a car with a red background, a car with a downward arrow, a car with an upward arrow, a car with a downward arrow, and a car with a camera icon.



OFF OFF OFF OFF OFF OFF OFF

22° 24° خارج 7:20 97.30 FM 22°



التطبيقات المركبة الهاتف Nav Comfort الوسائط الرئيسية



MUTE SCREEN OFF



2 غير غير FM

1

4 أنقر للحفظ 3 أنقر للحفظ 2 سر حفظ 1 للحفظ 1 كل المُسبقة

6 شارع 6 شارع ند الحمر

1

٢٢° ٢٤° خارج ٦:٢٣ 97.30 FM ٢٢°

ديناميكيات  
المركبة

2

زاوية التوجيه  
0°

ملحقات  
المقاييس

انحدار و  
التفاف

Selec-Terrain

الكاميرا الأمامية

حالة المقاييس

1

4WD  
HIGH

55°22'07" E 25°10'14" N ارتفاع -23 m

SNOW



التطبيقات



المركبة



الهاتف



Nav



Comfort



الوسائط



الرئيسية



OFF OFF OFF OFF OFF

٢٢° ٢٤° خارج ٦:٢٣ 97.30 FM ٢٢°

ديناميكيات المركبة

ملحقات المقاييس

انحدار و التفاف

Selec-Terrain

الكاميرا الأمامية



4WD HIGH 55°22'07" E 25°10'14" N ارتفاع -23 m SNOW

التطبيقات

المركبة

الهاتف

Nav

Comfort

الوسائط

الرئيسية

MUTE

SCREEN



۲۲° | ۲۴° خارج | ۶:۲۳ | 97.30 FM | ۲۲°

ديناميكيات المركبة 2

ملحقات المقاييس

انحدار و التفاف

Selec-Terrain

الكاميرا الأمامية

0°

انحدار

0°

التفاف

4WD HIGH 55°22'07" E 25°10'14" N ارتفاع -23 m SNOW

التطبيقات | المركبة | الهاتف | Nav | Comfort | الوسائط | الرئيسية

MUTE | SCREEN OFF

Vehicle Dynamics **2**

Accessory Gauges

Pitch & Roll

Selec-Terrain

Forward Facing Camera

4WD HIGH 55°22'03" E 25°10'06" N Altitude -19m AUTO

LO



36°  
OUT

4:37



ARABIYA



LO



### Selectable Tire Fill Alert



950



950

950

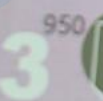

950



950

950

Apply and Save Preset

Presets



E  
A



Vehicle



MUTE



LO | | 36° OUT 4:28 FM ARABIYA | LO

Front Rear

2 2

Heat Heat

Vent Vent

1 1

Max A/C A/C Max Rear

3 3

Sync Off < 1 2 3 4 5 6 7 > Auto

MUTE

VOL

SCREEN OFF

REAR OFF AUTO

LO



36°  
OUT

4:37

FM ARABIYA



LO

Vehicle Dynamics

2



Steering Angle:  
0°



2

Accessory Gauges

Transfer Case:  
4WD HIGH

1



1

Pitch & Roll

Selec-Terrain

Forward Facing Camera

3

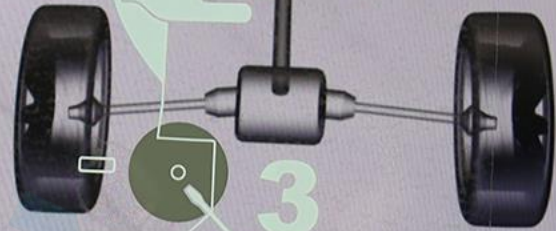

3

4WD HIGH

55°22'03" E

25°10'06" N

Altitude -19 m

AUTO



E  
▲



Vehicle



- Vehicle Dynamics **2**
- Accessory Gauges
- Pitch & Roll**
- Selec-Terrain
- Forward Facing Camera

The interface features two circular gauges. The left gauge is labeled 'Pitch' and shows a 0° reading with an upward-pointing arrow. The right gauge is labeled 'Roll' and also shows a 0° reading. Each gauge has a hand icon with a '1' and a '2' indicating touch gestures. Below the gauges, there are three circular control elements labeled '3', with a 'Pitch' label on the left and a 'Roll' label on the right. At the bottom of the central area, the text '4WD HIGH' is displayed in orange, followed by coordinates '55°22'03" E' and '25°10'06" N', and 'Altitude -19 m'. The word 'AUTO' is positioned at the bottom right of the central area.

LO

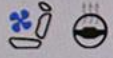

36°  
OUT

4:30

FM ARABIYA



LO

Favorites

Recent

Categories

All

2

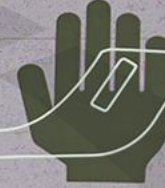

2



eco-Coaching

1



Comfort



Off Road Pages



1

3



3



E  
A



Apps



LO



36°  
OUT

4:38

FM ARABIYA



LO

Vehicle Dynamics

2

Accessory Gauges

Pitch & Roll

Selec-Terrain

Forward Facing Camera



3

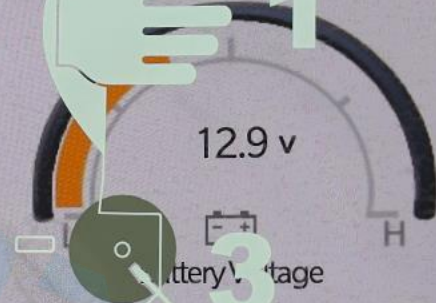

3

4WD  
HIGH

55°22'03" E 25°10'06" N

Altitude -19 m

AUTO



E  
A



Vehicle



Низ.

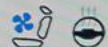

98°  
НАРУЖН.

4:01

FM STAR FM



Низ.

Избранные

Последние

Категории

Все

А - Я

Я - А



Автом.



Вент. водит.



Вент. пасс.



Допол.  
кабель



Затемнение  
зеркала



Камера  
зад. вида



Камера  
круг. обзо...



Комфорт



Главная



М/мед



Comfort



Nav



Тел.



Автом.



Прил.

Низ.

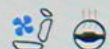

98°  
НАРУЖН.

4:02

FM STAR FM



Низ.

Динамика  
автомобиля

Вспомог.  
приборы

Попер.  
перемещения

Selec-Terrain

Камера  
переднего  
обзора

Угол поворота  
рулевого колеса:  
0°

Transfer Case:  
Разблокирована

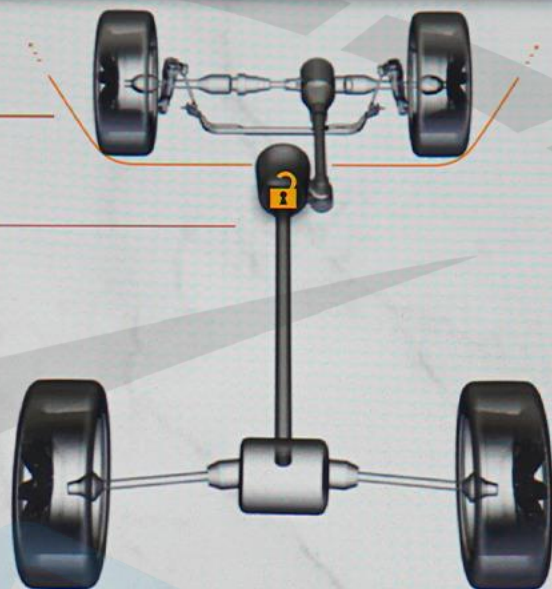

4WD HIGH

55°22'13" E

25°10'20" N

Высота -4 m

SPORT



Главная



M/мед



Comfort



Nav



Тел.



Автом.



Прил.

Низ.



98°  
НАРУЖН.

4:02

FM STAR FM



Низ.

Динамика  
автомобиля

Вспомог.  
приборы

Попер.  
перемещения

Selec-Terrain

Камера  
переднего  
обзора

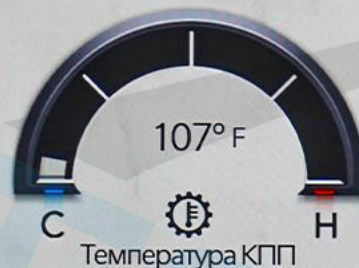

4WD HIGH

55°22'13" E

25°10'20" N

Высота -4 m

SPORT



Главная



М/мед



Comfort



Nav



Тел.



Автом.



Прил.

Низ.



98°  
НАРУЖН.

4:02

FM STAR FM



Низ.

Динамика  
автомобиля

Вспомог.  
приборы

Попер.  
перемещения

Selec-Terrain

Камера  
переднего  
обзора



0°

Наклон

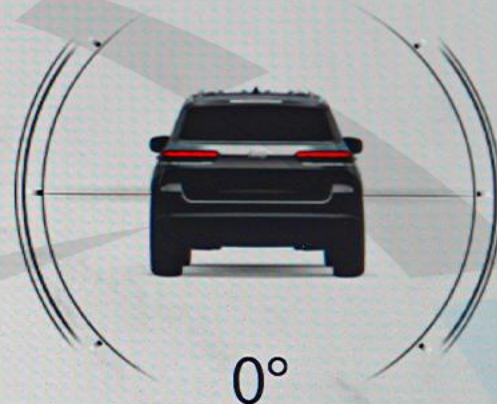

0°

Крен

4WD HIGH

55°22'13" E

25°10'20" N

Высота -4 m

SPORT



Главная



М/мед



Comfort



Nav



Тел.



Автом.



Прил.

Низ.



98°  
НАРУЖН.

4:02

FM STAR FM



Низ.

Динамика  
автомобиля

Вспомог.  
приборы

Попер.  
перемещения

Selec-Terrain

Камера  
переднего  
обзора



4WD HIGH

55°22'13" E

25°10'20" N

Высота -4 m

SPORT



Главная



М/мед



Comfort



Nav



Тел.



Автом.



Прил.

MUTE

AC

OFF

OFF

OFF

OFF

SCREEN

Низ.

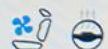

98°  
НАРУЖН.

4:02

FM STAR FM



Низ.

Динамика  
автомобиля

Вспомог.  
приборы

Попер.  
перемещения

Selec-Terrain

Камера  
переднего  
обзора



4WD HIGH

55°22'13" E

25°10'20" N

Высота -4 м

SNOW



Главная



М/мед



Comfort



Nav



Тел.



Автом.



Прил.

MUTE



SCREEN  
OFF

Низ.



98°  
НАРУЖН.

4:02

FM STAR FM



Низ.

Динамика  
автомобиля

Вспомог.  
приборы

Попер.  
перемещения

Selec-Terrain

Камера  
переднего  
обзора

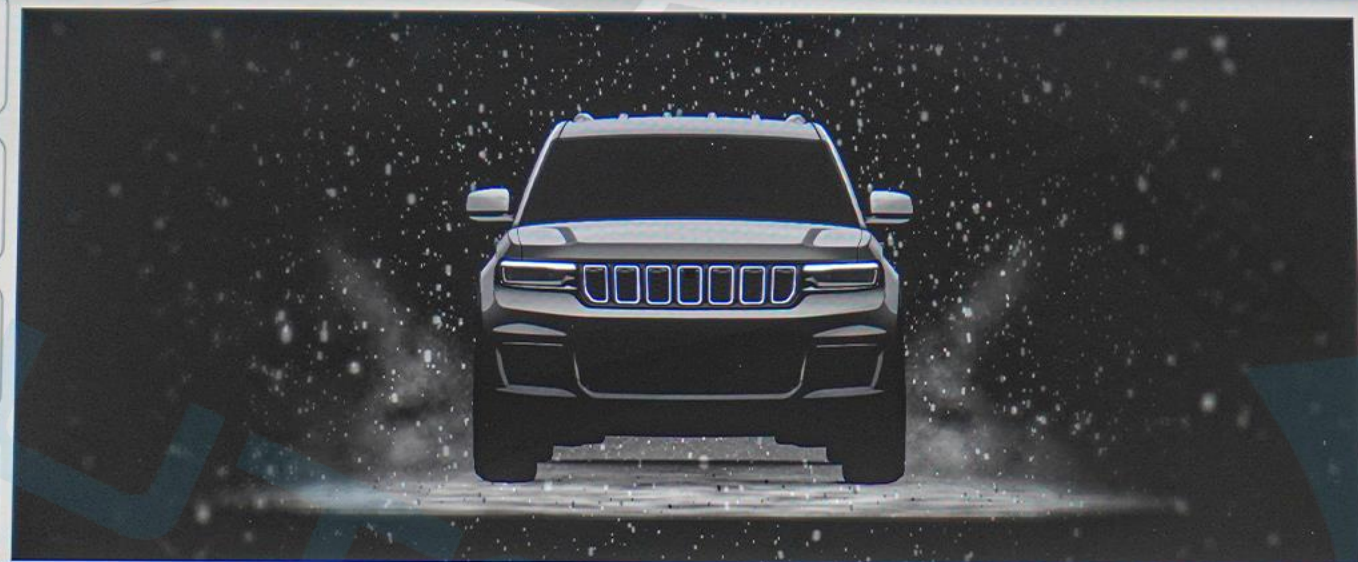

4WD HIGH

55°22'13" E

25°10'20" N

Высота -4 m

SNOW



Главная



М/мед



Comfort



Nav



Тел.



Автом.



Прил.

MUTE



SCREEN  
OFF



Последние Категории Все

Vertical menu with icons and a slider:

- 
- 
- 
- Синх.

Main grid of application icons:

- Вент. водит.
- Вент. пасс.
- Допол. кабель
- Камера зад. вида
- Камера круг. обзо...
- Комфорт

Низ.

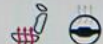

98°  
НАРУЖН.

4:04

FM STAR FM



Низ.

Передн.

Задний



Об.



Вен



Пер. обдув

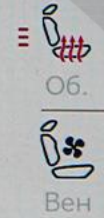

Об.



Вен

Макс. A/C

A/C

Максим.

Задний

Синхр.

Off



1

2

3

4

5

6

7



Авт.



Главная



M/мед



Comfort



Nav



Тел.



Автом.



Прил.

Vehicle Dynamics **2**

Accessory Gauges

Pitch & Roll

Selec-Terrain

Forward Facing Camera

4WD HIGH 55°22'03" E 25°10'06" N Altitude -19m AUTO

LO



36°  
OUT

4:37



ARABIYA



LO



### Selectable Tire Fill Alert

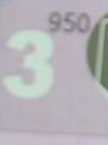

Apply and Save Preset

Presets



E  
A



Vehicle



MUTE



LO | | 36° OUT 4:28 FM ARABIYA | LO

Front Rear

2 2

Heat Heat

Vent Vent

1 1

Max A/C A/C Max Rear

3 3

Sync Off < 1 2 3 4 5 6 7 > Auto

Comfort

MUTE SCREEN OFF

VOL

REAR OFF AUTO

ENTER

التطبيقات

المركبة

الهاتف

Nav

Comfort

الوسائط

الرئيسية

MUTE



SCREEN OFF



MAX

REAR

OFF



AUTO

A/C



التطبيقات

المركبة

الهاتف

Nav

Comfort

الوسائط

الرئيسية

MUTE



SCREEN OFF



MAX

REAR

OFF



AUTO

A/C





Home



Media



Comfort



Nav



Phone



Vehicle



Apps

MUTE



SCREEN OFF



OFF



AUTO

A/C





SAND/MUD  
SNOW  
AUTO  
SPORT



P

R

MAX

REAR

OFF

AUTO

A/C



12V DC

1

AUX

2



SAND/MUD  
SNOW  
AUTO  
SPORT

P R N D



VOL REAR OFF AUTO A/C AUNE ENTER

1 AUX 2 12V DC

SAND/MUD  
SNOW  
AUTO  
SPORT

**P** R N D



115 V AC  
150 W

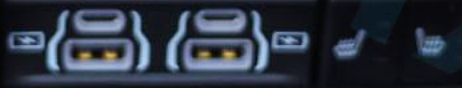

115 V AC  
150 W













Interior control panel featuring a central display area with a car icon, an OFF/ON toggle switch, a red SOS button, and three buttons labeled OPEN/AUTO/CLOSE, TILT/VENT/DOWN, and OPEN/AUTO/CLOSE. The panel is flanked by two illuminated visor storage compartments.

**AIRB**

Warning label with a red prohibition symbol over a person sitting in a car seat, and a diagram showing a person's head and neck position relative to the seat.





HOLD  
TO SET



PULL ON







12V DC











ALPINE









GNTX0930E31179



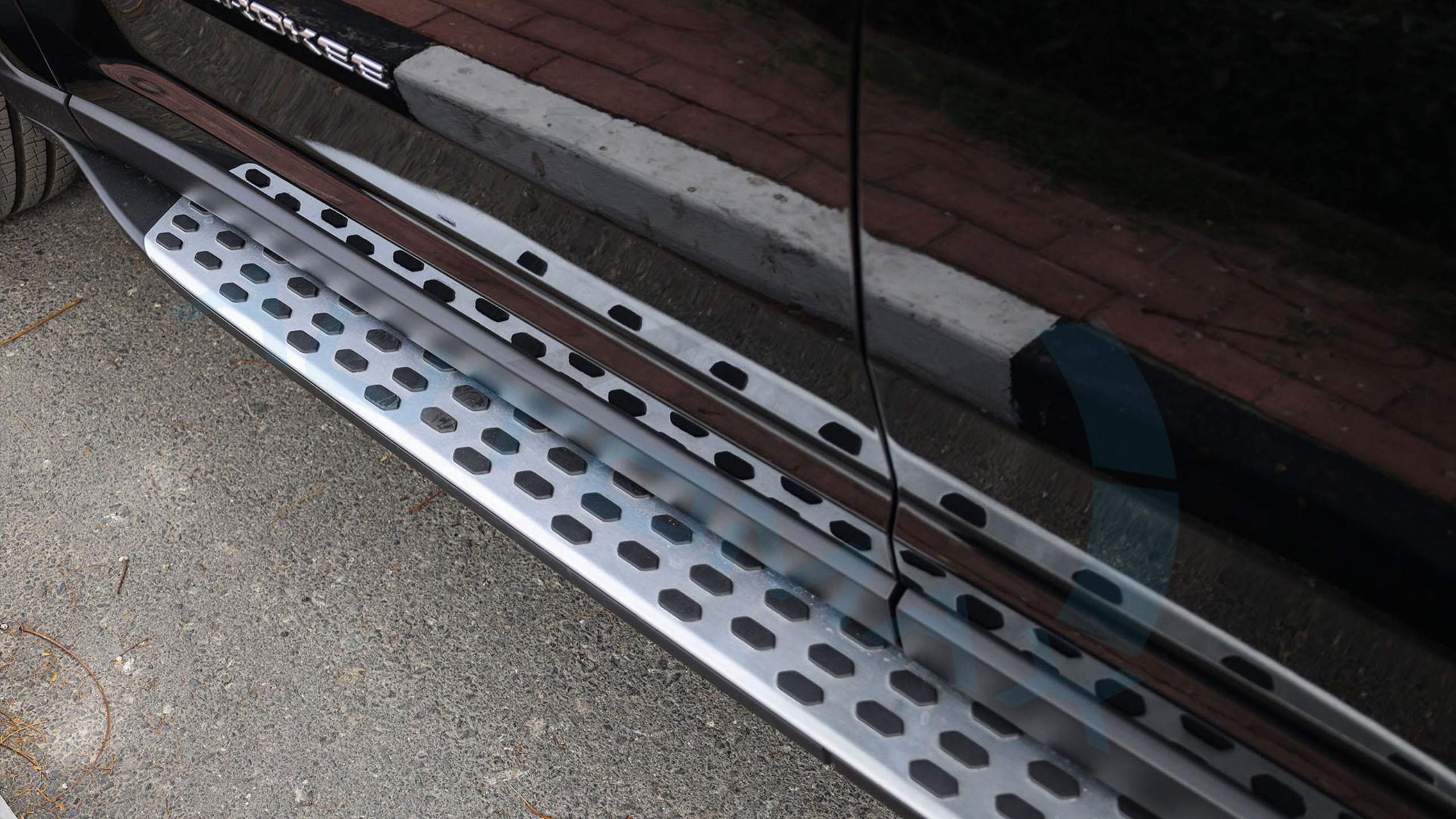







GRAND CHEROKEE

LIMITED

QXQ



Manufacturer Name

FCA US LLC

اسم الصانع

Model Year

2024

سنة النموذج

Label No

158340

رقم البطاقة

Vehicle Type

FCA US LLC JEEP Grand Cherokee 3.6L SUV 4WD 4Doors

نوع المركبة

Fuel Economy

اقتصاد الوقود



هيئة التقييس  
لدول مجلس التعاون لدول الخليج العربية  
GCC Standardization Organization

Fuel Type

نوع الوقود

Gasoline Euro IV

بنزين

Fuel Economy

اقتصاد الوقود

12 km/L

Vehicle Class

فئة المركبة

Light Truck



إزالة أو تغطية أو إتلاف هذه البطاقة قبل البيع يعرض للملاحقة القانونية  
Removing, covering or damaging this label before sale is punishable by law





GRAND CHEROKEE









لمشاهدة صورة السيارة بزاوية 360 درجة إضغط على الصورة أعلاه

Для просмотра автомобиля в формате 360°, пожалуйста, нажмите на фото выше.

To view the 360° degree please press on the picture above

# 2024 JEEP GRAND CHEROKEE LIMITED PLUS LUXURY 4X4 GCC 0Km

Бренд: JEEP

Brand: JEEP

الماركة: جيب

Категория: GRAND CHEROKEE

Category: GRAND CHEROKEE

الفئة: جراند شيروكي

Модель: LIMITED PLUS LUXURY

Model: LIMITED PLUS LUXURY

الموديل: ليمتد بلس لكشري

Год: 2024

Year: 2024

السنة: 2024

Километров: 0 км

Kilometers: 0Km

كيلومترات: 0 كم

Двери: 4

Doors: 4 Doors

عدد الأبواب: أربعة ابواب

Цвет: Бриллиантовый Черный

Color: Diamond Black

اللون: أسود

Цилиндр: 6

Cylinder: 6 Cylinders

عدد الاسطوانات: 6 أسطوانات

Лошадиные силы: 293 HP

Horsepower: 293 HP

عدد الأحصنة: 293 حصان

Трансмиссия: Автоматическая

Transmission: Automatic

نوع النقل : نقل أوتوماتيكي

Топливо: Бензин

GCC Specifications

المواصفات الإقليمية: الخليجية

Производство: 2024

Fuel: Gasoline

نوع الوقود: بنزين

# 2024 JEEP GRAND CHEROKEE LIMITED PLUS LUXURY 4X4 GCC 0Km

CAPRI LEATHERETTE W/AXIS II SEATS

GLOBAL BLACK/WICKER BEIGE

MIDDLE EAST EQUIPMENT GROUP

EMEA EQUIPMENT GROUP

LUXURY TECH GROUP II

SMOKER'S GROUP

AUX BATTERY

ADVANCED BRAKE ASSIST

ANTI-LOCK 4-WHEEL FNC DISC BRAKES

VENTILATED FRONT SEATS

CARGO COMPARTMENT COVER

REMOVABLE ASH TRAY

8-SPD AUTO 8HP50 TRANS (BUY)

3.6L V6 24V VVT ENGINE UPG I W/ESS

LIGHT TINT SOLAR CONTROL GLASS

WINDOW SHADES, 2ND ROW, MANUAL

AUTO DIM EXTERIOR DRIVER MIRROR

RRVIEW AUTODIM DIGITAL DISPLAY MIRROR

DUAL-PANE PANORAMIC SUNROOF

PASSIVE ENTRY-FRT/RR DOORS, LIFTGATE

240 KPH PRIMARY SPEEDOMETER

RAIN SENSITIVE WINDSHIELD WIPERS

REAR BACK UP CAMERA WASHER

CIGAR LIGHTER

GPS NAVIGATION

GPS ANTENNA INPUT

ACTIVE NOISE CONTROL SYSTEM

EXT. MIRRORS W/SUPPLEMENTAL SIGNALS

EXTERIOR MIRRORS W/ARABIC LETTERING

EXTERIOR MIRRORS W/MEMORY

# 2024 JEEP GRAND CHEROKEE LIMITED PLUS LUXURY 4X4 GCC 0Km

MEMORY STEERING COLUMN

HEATED EXTERIOR MIRRORS

GLOSS BLACK EXTERIOR MIRRORS

MANUAL FOLDING EXTERIOR MIRRORS

REAR LED FOG LAMPS

LED DAYTIME RUNNING LAMPS- LOW BEAM

PEDESTRIAN/CYCLIST EMERGENCY BRAKING

FRONT LICENSE PLATE BRACKET

EXPORT EMISSIONS

EURO STAGE 6B EMISSIONS

ENGINE OIL COOLER

TRANSMISSION HEATER

DIAMOND BLACK CRYSTAL P/C

ALL RADIO EQUIPPED VEHICLES

9 AMPLIFIED SPEAKERS W/SUBWOOFER

GLOBAL TELEMATICS BOX MODULE (TBM)

506 WATT AMPLIFIER

APPLE CARPLAY

DISASSOCIATED TOUCHSCREEN DISPLAY

WIRELESS CHARGING PAD

GOOGLE ANDROID AUTO

USB HOST FLIP

BODY COLOR SHARK FIN ANTENNA

10.1" TOUCHSCREEN DISPLAY

DIGITAL AUDIO BROADCASTING

INTEGRATED CENTER STACK RADIO

ALL R1 HIGH RADIOS

EXPORT TUNED SUSPENSION

POWER TILT/TELESCOPE STEERING COLUMN

FULL SIZE SPARE TIRE

# 2024 JEEP GRAND CHEROKEE LIMITED PLUS LUXURY 4X4 GCC 0Km

265/50R20 PERFORMANCE A/S TIRES

PIRELLI BRAND TIRES

UCONNECT 5 NAV W 10.1" DISP(ROW+DAB)

REST OF WORLD RADIO COUNTRIES

20X8.5 MACHINED/PAINTED ALUM WHEEL

ALL ALUMINUM WHEELS

18" FULL SIZE STEEL SPARE WHEEL

SURROUND VIEW CAMERA SYSTEM

NEXT MODEL YEAR VEHICLE TRACKING

PARKSENSE FR/RR PARK ASSIST W/STOP

ARABIC LANGUAGE

INTEGRATED OFF-ROAD CAMERA

INTERSECTION COLLISION ASSIST SYSTEM

INTEGRATED VOICE COMMAND W/BLUETOOTH

MIDEAST EMERGENCY RESPONSE ASSIST <sup>®</sup>

ALL PARKSENSE SYSTEMS

3 ADDITIONAL GALLONS OF GAS

# 2024 JEEP GRAND CHEROKEE LIMITED PLUS LUXURY 4X4 GCS 0Km

EURO 6

Зимний Пакет

Вентиляция и Подогрев Сидений

Рулевое Колесо с Подогревом

Боковые Зеркала с Подогревом

Электрорегулировка сидений с памятью позиций

Адаптивный круиз-контроль

Камера 360 градусов

Регулируемые режимы вождения (включая Зимний режим)

Премиум LED оптика

Панорамная Крыша

Боковые подножки

Стереосистема Alpine с 9 динамиками и сабвуфером

Система удержания в полосе

Зеркало с камерой заднего вида

Система помощи при спуске

Система экстренного торможения

Система контроля слепых зон

Система Start/Stop

Контроль скорости

Бесключевой доступ

Бесключевой старт

Дистанционный запуск двигателя

10,1-дюймовый сенсорный дисплей

Беспроводная зарядка для телефона

Задние Шторки

Система Мониторинга Слепых Зон

Apple CarPlay & Android Auto

# 2024 JEEP GRAND CHEROKEE LIMITED PLUS LUXURY 4X4 GCC 0Kم

\* الأداء:

ناقل حركة أوتوماتيكي ب 8 سرعات

عدد الأسطوانات: 6 أسطوانات

سعة المحرك: 3.6 ليتر

العزم: 352 نيوتن.متر

عدد الأحصنة: 293 حصان

دفع رباعي 4X4

\* المواصفات الإضافية:

OFF ROAD PAGES

رادار

فتحة سقف بانوراما

مثبت السرعة التكميلي

محدد سرعة الكتروني

نظام مكابح متقدم مع الفرامل التلقائية

نظام البطارية المزدوجة للبدء والتوقف

كاميرا بزواوية 360

نظام صوتي متقدم من Alpine

كاميرا المرآة الداخلية

خاصية تبريد وتدفئة المراتب

خاصية تدفئة المقود

خاصية تسخين المرايا الجانبية

عتبات جانبية



# 2024 JEEP GRAND CHEROKEE LIMITED PLUS LUXURY 4X4 GCC 0Km

حساسات متقدمة

التشغيل عن بعد

تثبيت مسار

خاصية تنظيف الكاميرا

الوضعيات المتعددة للقيادة

دخول بصمة

خاصية الكشف عن النقطة العمياء

مراتب كهربائية متعددة الوضعيات مع خاصية الذاكرة

شاشة تعمل باللمس قياس حجم 10.1 بوصة

اللغة عربية

نظام الملاحة وتحديد المواقع

آمر صوتي متكامل مع بلوتوث

دبّة كهرباء

مخارج طاقة كهربائية متعددة

شاحن هاتف لاسلكي امامي

ستائر خلفية

إنارة متقدمة

عازل حراري خارجي للزجاج

عازل للضجيج الخارجي

ابل كاربلاي + اندرويد أوتو

# AUTOMAX®

The Boutique Of Muscle Cars, Truck Fanatics & German Automotive Experts.



نتكلم اللغة العربية

WE SPEAK ENGLISH

ON PARLE LE FRANCAIS

Nosotros hablamos español

мы говорим по-русски

biz o'zbek tilida

gaplashamiz

हम हिंदी बोलते हैं



[automaxgroup.me](http://automaxgroup.me)



[automax group](https://www.youtube.com/automaxgroup)



[automax.dxb](https://www.snapchat.com/add/automax.dxb)



[Automax\\_LLC](https://www.telegram.com/Automax_LLC)



[+971 50 602 7200](https://www.whatsapp.com/+971506027200)



[automax.dxb](https://www.instagram.com/automax.dxb)



[automax.dxb](https://www.facebook.com/automax.dxb)



[automax.dxb](https://www.tiktok.com/automax.dxb)



[automax\\_dxb](https://www.twitter.com/automax_dxb)



[automax group L.L.C](https://www.linkedin.com/company/automax-group-l-l-c)

New Auto Market - Dubai - United Arab Emirates

[Directions](#)