



Jeep

GRAND CHEROKEE



Jeep





GRAND CHEROKEE

Jeep

AUTOMAX  
AUTOMAX.uae

L 4x4



Jeep

AUTOMAX  
AUTOMAX  
Tel: 04 - 3205680 / Mob: 05 277 277 07

4x4

LIMITED



Jeep

AUTOMAX  
AUTOMAX  
Tél: 04 - 330 000 | Fax: 04 332 377 87

LIMITED

GRAND CHEROKEE





Jeep

AIRBAG

NOV 11:39

Search



NAV

SAFETY

MAX REAR

AUX

1 2





Jeep

AIRBAG

R

Jeep

AIRBAG



SET+



CANC



RES



SET-

N

0 km/h P

92°F

Current 0

9.6  
MPG

Average

FM EDUCATION  
ZAYED FM

FM 97.60 MHz

0°



C H

30 km

(!) E F



0 km/h P 88°F

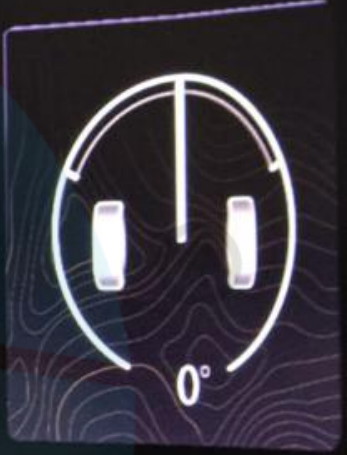

Press OK to Select

Hold OK to Edit

32 km



E



F



--

4. Off Road

0 km/h P

88°F

**AUTO**

Automatic Full

Time 4WD

Adapts to

Road Conditions



**Terrain Status**

32 km

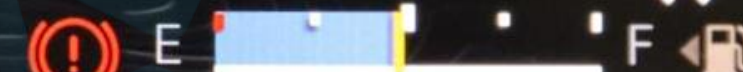

--

4. Off Road

0 km/h P

88°F

AUTO

Automatic Full

Time 4WD

Adapts to  
Road Conditions



Terrain Status

32 km



--

4. Off Road

0 km/h P

88°F

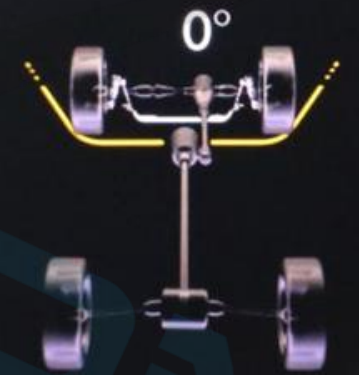

Vehicle Dynamics

32 km

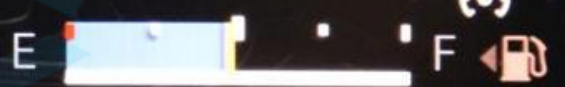
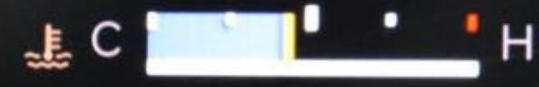

--

4. Off Road

0 km/h P

88°F



3°



0°



RPM X 1000

Pitch & Roll

32 km



E



F





4. Off Road

0 km/h P



3°



0°



RPM X 1000

Pitch & Roll

32 km

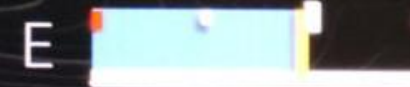

# Check Entire Surroundings



Top View

Rear View

The main display area is split into two panels. The left panel, labeled 'Top View', shows a top-down perspective of a car on a road. The right panel, labeled 'Rear View', shows a rear-facing camera view of the road. Hand gesture icons are overlaid on both panels, with numbers 1, 2, and 3 indicating different gestures. In the Top View, gesture 1 is a hand with fingers spread, gesture 2 is a hand with fingers curled, and gesture 3 is a hand with the index finger pointing. In the Rear View, gesture 1 is a hand with fingers spread, gesture 2 is a hand with fingers curled, and gesture 3 is a hand with the index finger pointing. A white arrow points upwards in the center of the Rear View panel. A white box highlights a specific area in the Rear View panel.

- 
- 
- 
- 
-

Select a seat to change zoom view



MUTE



LO | 36° OUT | 4:28 | FM ARABIYA | LO

Front Rear

2 2

Heat Heat

Vent Vent

1 1

3 Max A/C A/C Max 3 Rear



















Sync Off < 1 2 3 4 5 6 7 > Auto

MUTE SCREEN OFF

VOL ENTER

REAR OFF AUTO

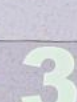
Off Road Controls Settings

  Mirror Dimmer	  3rd Row Headrest Fold	  Surround Camera
  FamCam	  Forward Facing Camera	  Rear View Camera
 	 	 



- Vehicle Dynamics **2**
- Accessory Gauges
- Pitch & Roll**
- Selec-Terrain
- Forward Facing Camera

The interface features two circular gauges. The left gauge is labeled 'Pitch' and shows a 0° reading with an upward-pointing arrow. The right gauge is labeled 'Roll' and also shows a 0° reading. Each gauge has a hand icon with a '1' indicating touch interaction and a hand icon with a '2' indicating a second touch or drag. A '3' is placed near a central dial on each gauge. Below the gauges, the text '4WD HIGH' is displayed in orange, followed by coordinates '55°22'03" E' and '25°10'06" N', and 'Altitude -19 m'. The word 'AUTO' is positioned in the bottom right corner of the gauge area.

LO



36°  
OUT

4:38

FM ARABIYA



LO

Vehicle Dynamics

2

Accessory Gauges

Pitch & Roll

Selec-Terrain

Forward Facing Camera

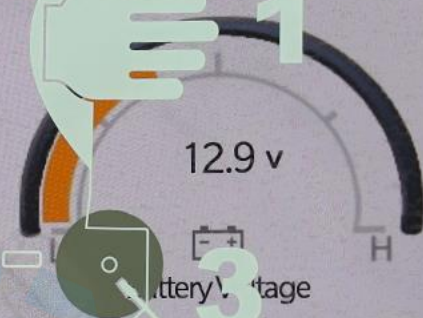
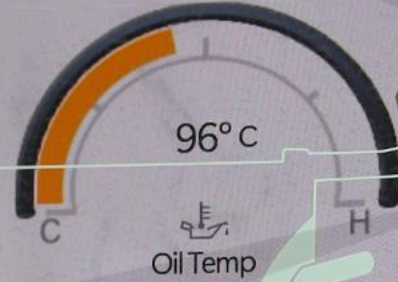

4WD  
HIGH

55°22'03" E 25°10'06" N

Altitude -19 m

AUTO



E  
A



Vehicle



LO



36°  
OUT

4:37

FM ARABIYA



LO

Vehicle Dynamics

2



Steering Angle:  
0°



2

Accessory Gauges

Transfer Case:  
4WD HIGH

1



1

Pitch & Roll

Selec-Terrain

Forward Facing Camera

3

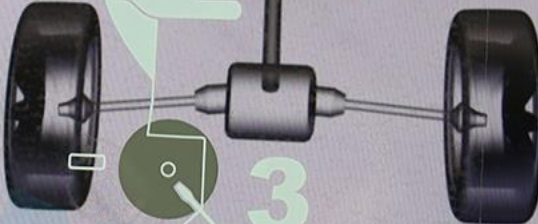

3

4WD  
HIGH

55°22'03" E

25°10'06" N

Altitude -19 m

AUTO



Vehicle





LO



36°  
OUT

4:37

FM ARABIYA



LO

### Selectable Tire Fill Alert

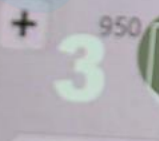

Apply and Save Preset



Presets



E  
A



Vehicle



LO



36°  
OUT

4:30

FM ARABIYA



LO

Favorites

Recent

Categories

All

2



2



eco-Coaching

1



Comfort



Off Road Pages



1

3



3



E  
A



Apps

**Vehicle Dynamics** **2**

Accessory Gauges

Pitch & Roll

Selec-Terrain

Forward Facing Camera

4WD HIGH 55°22'03" E 25°10'06" N Altitude -19m AUTO

Низ.

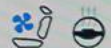

98°  
НАРУЖН.

4:01

FM STAR FM



Низ.

Избранные

Последние

Категории

Все

А - Я

Я - А



Автом.



Вент. водит.



Вент. пасс.



Допол.  
кабель



Затемнение  
зеркала



Камера  
зад. вида



Камера  
круг. обзо...



Комфорт



Главная



М/мед



Comfort



Nav



Тел.



Автом.



Прил.

Последние Категории Все

Vertical menu with icons and a slider:

- 
- 
- 
- Синх.

Main grid of application icons:

- Вент. водит.
- Вент. пасс.
- Допол. кабель
- Камера зад. вида
- Камера круг. обзо...
- Комфорт

Низ.

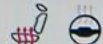

98°  
НАРУЖН.

4:04

FM STAR FM



Низ.

Передн.

Задний



Об.

Вен



Пер. обдув

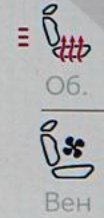
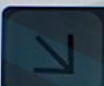

Об.

Вен



Макс. А/С

A/C

Максим.

Задний

Синхр.

Off



1

2

3

4

5

6

7



Авт.



Главная



М/мед



Comfort



Nav



Тел.



Автом.



Прил.

Низ.



98°  
НАРУЖН.

4:03

FM STAR FM



Низ.

Бездорожье

Элементы управления

Настройки



Затем. зер.  
зад. вида



Склад.  
подгол.  
3 ряда



Кам. круг.  
обзора



FamCam



Камера  
передн.  
вида



Rear View  
Camera



Главная



М/мед



Comfort



Nav



Тел.



Автом.



Прил.

Низ.



98°  
НАРУЖН.

4:02

FM STAR FM



Низ.

Динамика  
автомобиля

Вспомог.  
приборы

Попер.  
перемещения

Selec-Terrain

Камера  
переднего  
обзора

Угол поворота  
рулевого колеса:  
0°

Transfer Case:  
Разблокирована

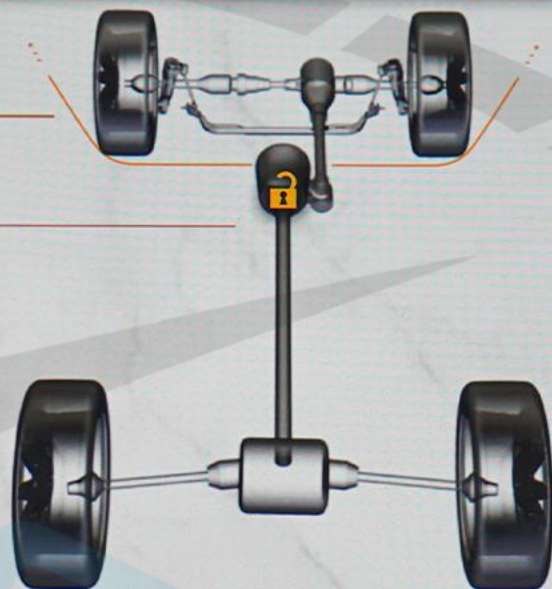

4WD HIGH

55°22'13" E

25°10'20" N

Высота -4 m

SPORT



Главная



М/мед



Comfort



Nav



Тел.



Автом.



Прил.



Низ.



98°  
НАРУЖН.

4:02

FM STAR FM



Низ.

Динамика  
автомобиля

Вспомог.  
приборы

Попер.  
перемещения

Selec-Terrain

Камера  
переднего  
обзора



4WD HIGH

55°22'13" E

25°10'20" N

Высота -4 m

SPORT



Главная



М/мед



Comfort



Nav



Тел.



Автом.



Прил.

Низ.



98°  
НАРУЖН.

4:02

FM STAR FM



Низ.

Динамика  
автомобиля

Вспомог.  
приборы

Попер.  
перемещения

Selec-Terrain

Камера  
переднего  
обзора



0°

Наклон

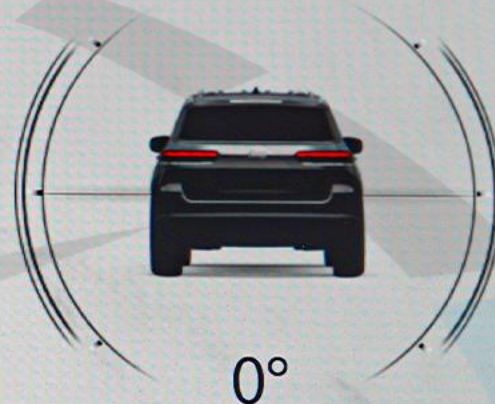

0°

Крен

4WD HIGH

55°22'13" E

25°10'20" N

Высота -4 m

SPORT



Главная



М/мед



Comfort



Nav



Тел.



Автом.



Прил.

Низ.



98°

НАРУЖН.

4:02



STAR FM



Низ.

Динамика  
автомобиля

Вспомог.  
приборы

Попер.  
перемещения

Selec-Terrain

Камера  
переднего  
обзора



4WD HIGH

55°22'13" E

25°10'20" N

Высота -4 m

SPORT



Главная



М/мед



Comfort



Nav



Тел.



Автом.



Прил.

MUTE

OFF

OFF

OFF

OFF

OFF

SCREEN

Низ.

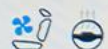

98°  
НАРУЖН.

4:02

FM STAR FM



Низ.

Динамика  
автомобиля

Вспомог.  
приборы

Попер.  
перемещения

Selec-Terrain

Камера  
переднего  
обзора



4WD HIGH

55°22'13" E

25°10'20" N

Высота -4 м

SNOW



Главная



М/мед



Comfort



Nav



Тел.



Автом.



Прил.

MUTE



SCREEN  
OFF

Низ.



98°  
НАРУЖН.

4:02

FM STAR FM



Низ.

Динамика  
автомобиля

Вспомог.  
приборы

Попер.  
перемещения

Selec-Terrain

Камера  
переднего  
обзора

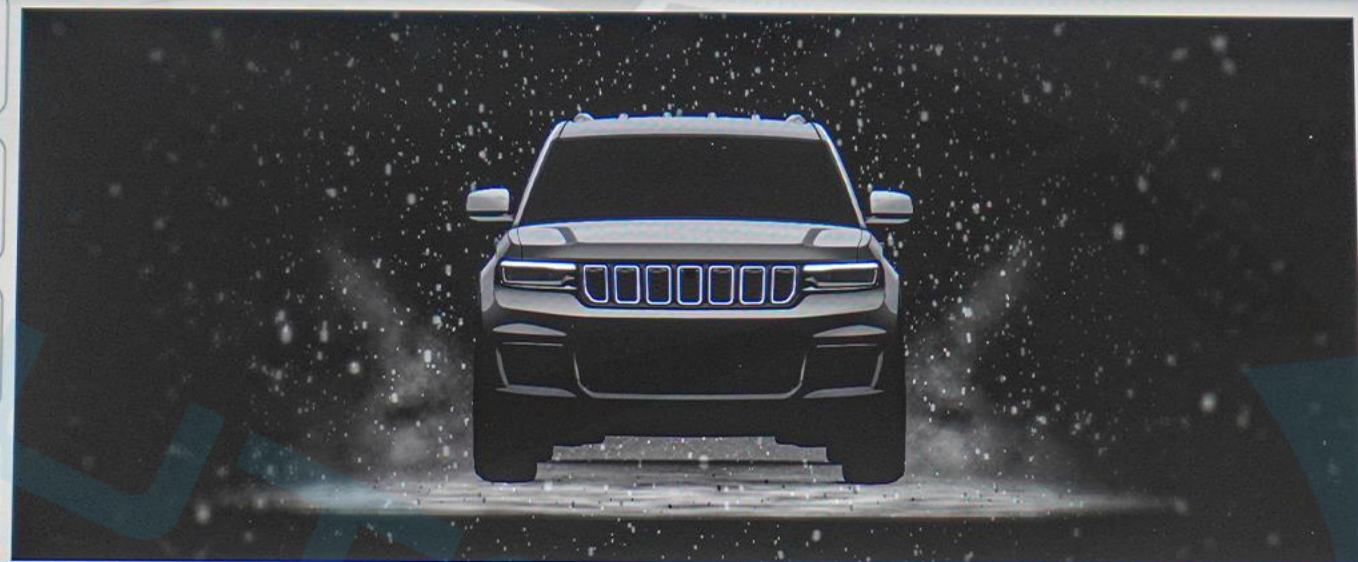

4WD HIGH

55°22'13" E

25°10'20" N

Высота -4 m

SNOW



Главная



М/мед



Comfort



Nav



Тел.



Автом.



Прил.

MUTE



SCREEN  
OFF

23° 24° خارج ٦:٢٢ 97.30 FM 23°

2 غير غير FM

1

4 أنقر للحفظ 3 أنقر للحفظ 2 سر حفظ 1 للحفظ 1 كل المُسبقة

6 شارع

بحث شارع ند الحمر

1

- التطبيقات
- المركبة
- الهاتف
- Nav
- Comfort
- الوسائط
- الرئيسية

أراض وعزم متحكّمات إعدادات

2 كاميرا الرؤية المحيطة	طبي مسند الرأس للصف الثالث	معتم المرأة
1 كاميرا الرؤية الخلفية	الكاميرا الأمامية	amCam

MUTE

SCREEN

22° 24° خارج ٦:٢٣ 97.30 FM 22°

ديناميكيات  
المركبة

ملحقات  
المقاييس

انحدار و  
التفاف

Selec-Terrain

الكاميرا الأمامية

زاوية التوجيه  
0°

حالة المقاييس

4WD  
HIGH

55°22'07" E

25°10'14" N

ارتفاع -23 m

SNOW



التطبيقات



المركبة



الهاتف



Nav



Comfort



الوسائط



الرئيسية



OFF OFF OFF OFF OFF

٢٢° ٢٤° خارج ٦:٢٣ 97.30 FM ٢٢°

ديناميكيات المركبة

ملحقات المقاييس

انحدار و التفاف

Selec-Terrain

الكاميرا الأمامية



4WD HIGH 55°22'07" E 25°10'14" N ارتفاع -23 m SNOW

التطبيقات المركبة الهاتف Nav Comfort الوسائط الرئيسية

MUTE SCREEN



۲۲° | ۲۴° خارج | ۶:۲۳ | 97.30 FM | ۲۲°

ديناميكيات المركبة 2

ملحقات المقاييس

انحدار و التفاف

Selec-Terrain

الكاميرا الامامية

انحدار 0°

التفاف 0°

4WD HIGH 55°22'07" E 25°10'14" N ارتفاع -23 m SNOW

التطبيقات | المركبة | الهاتف | Nav | Comfort | الوسائط | الرئيسية

MUTE | SCREEN OFF

OFF OFF OFF OFF OFF OFF OFF OFF

22° 24° خارج 7:20 97.30 FM 22°



التطبيقات المركبة الهاتف Nav Comfort الوسائط الرئيسية



MUTE SCREEN OFF





Home



Media



Comfort



Nav



Phone



Vehicle



Apps

MUTE



SCREEN OFF

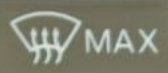

OFF



AUTO

A/C



MAX

REAR

OFF

AUTO

A/C



1



AUX



2



12V DC



SAND/MUD  
SNOW  
AUTO  
SPORT

P R N D



SAND/MUD  
SNOW  
AUTO  
SPORT

P R N D









115 V AC  
150 W





















//////LPNE





12V DC





GNTX0303229217



Jeep









GRAND CHEROKEE





SCORPION VERDE

265/50 R20  
265/50-R20-107V M+S

Jeep

PIRELLI

PIRELLI

DOT-NR K8-RS42 M2



# 2024 JEEP GRAND CHEROKEE L LIMITED PLUS LUXURY 4X4 GCC 0Km

Бренд: JEEP

Brand: JEEP

الماركة: جيب

Категория: GRAND CHEROKEE L

Category: GRAND CHEROKEE L

الفئة: جراند شيروكي ال

Модель: LIMITED PLUS LUXURY

Model: LIMITED PLUS LUXURY

الموديل: ليمند بلس لكشري

Год: 2024

Year: 2024

السنة: 2024

Километров: 0 км

Kilometers: 0Km

كيلومترات: 0 كم

Двери: 4

Doors: 4 Doors

عدد الأبواب: أربعة ابواب

Цвет: Серый

Color: Baltic Grey

اللون: رمادي

Цилиндр: 6

Cylinder: 6 Cylinders

عدد الاسطوانات: 6 أسطوانات

Лошадиные силы: 293 HP

Horsepower: 293 HP

عدد الأحصنة: 293 حصان

Трансмиссия: Автоматическая

Transmission: Automatic

نوع النقل : نقل أوتوماتيكي

Топливо: Бензин

GCC Specifications

المواصفات الإقليمية: الخليجية

Fuel: Gasoline

نوع الوقود: بنزين

# 2024 JEEP GRAND CHEROKEE L LIMITED PLUS LUXURY 4X4 GCC 0Km

CAPRI LEATHERETTE W/AXIS II SEATS

GLOBAL BLACK/WICKER BEIGE

MIDDLE EAST EQUIPMENT GROUP

EMEA EQUIPMENT GROUP

LUXURY TECH GROUP II

SMOKER'S GROUP

220 AMP ALTERNATOR

AUX BATTERY

ADVANCED BRAKE ASSIST

ANTI-LOCK 4-WHEEL FNC DISC BRAKES

VENTILATED FRONT SEATS

2ND ROW 60/40 BENCH, MAN TIP/SLIDE

CENTER REAR 3-POINT SEAT BELT

CARGO COMPARTMENT COVER

THREE REAR SEAT HEAD RESTRAINTS

2ND ROW SEAT CTR ARMREST/CUPHOLDERS

REMOVABLE ASH TRAY

7 PASSENGER SEATING

MANUAL FOLD SEATBACKS

8-SPD AUTO 8HP50 TRANS (BUY)

3.6L V6 24V VVT ENGINE UPG I W/ESS

LIGHT TINT SOLAR CONTROL GLASS

WINDOW SHADES, 2ND ROW, MANUAL

AUTO DIM EXTERIOR DRIVER MIRROR

RRVIEW AUTODIM DIGITAL DISPLAY MIRROR

DUAL-PANE PANORAMIC SUNROOF

PASSIVE ENTRY-FRT/RR DOORS, LIFTGATE

240 KPH PRIMARY SPEEDOMETER

RAIN SENSITIVE WINDSHIELD WIPERS

REAR BACK UP CAMERA WASHER

# 2024 JEEP GRAND CHEROKEE L LIMITED PLUS LUXURY 4X4 GCC 0Km

CIGAR LIGHTER

GPS NAVIGATION

GPS ANTENNA INPUT

ACTIVE NOISE CONTROL SYSTEM

EXT. MIRRORS w/SUPPLEMENTAL SIGNALS

EXTERIOR MIRRORS w/ARABIC LETTERING

EXTERIOR MIRRORS w/MEMORY

MEMORY STEERING COLUMN

HEATED EXTERIOR MIRRORS

GLOSS BLACK EXTERIOR MIRRORS

MANUAL FOLDING EXTERIOR MIRRORS

REAR LED FOG LAMPS

LED DAYTIME RUNNING LAMPS- LOW BEAM

PEDESTRIAN/CYCLIST EMERGENCY BRAKING

FRONT LICENSE PLATE BRACKET

EXPORT EMISSIONS

EURO STAGE 6B EMISSIONS

DUAL EXHAUST TIPS

ENGINE OIL COOLER

TRANSMISSION HEATER

HEAVY DUTY ENGINE COOLING

BALTIC GREY METALLIC CLEAR COAT

ALL RADIO EQUIPPED VEHICLES

9 AMPLIFIED SPEAKERS w/SUBWOOFER

GLOBAL TELEMATICS BOX MODULE (TBM)

506 WATT AMPLIFIER

APPLE CARPLAY

DISASSOCIATED TOUCHSCREEN DISPLAY

WIRELESS CHARGING PAD

GOOGLE ANDROID AUTO

# 2024 JEEP GRAND CHEROKEE L LIMITED PLUS LUXURY 4X4 GCC 0Km

USB HOST FLIP

BODY COLOR SHARK FIN ANTENNA

10.1" TOUCHSCREEN DISPLAY

DIGITAL AUDIO BROADCASTING

INTEGRATED CENTER STACK RADIO

ALL R1 HIGH RADIOS

EXPORT TUNED SUSPENSION

POWER TILT/TELESCOPE STEERING COLUMN

FULL SIZE SPARE TIRE

265/50R20 PERFORMANCE A/S TIRES

PIRELLI BRAND TIRES

UCONNECT 5 NAV W 10.1" DISP(ROW+DAB)

REST OF WORLD RADIO COUNTRIES

20X8.5 MACHINED/PAINTED ALUM WHEEL

ALL ALUMINUM WHEELS

18" FULL SIZE STEEL SPARE WHEEL

SURROUND VIEW CAMERA SYSTEM

NEXT MODEL YEAR VEHICLE TRACKING

PARKSENSE FR/RR PARK ASSIST W/STOP

ARABIC LANGUAGE

INTEGRATED OFF-ROAD CAMERA

INTERIOR REAR FACING CAMERA

INTERSECTION COLLISION ASSIST SYSTEM

INTEGRATED VOICE COMMAND W/BLUETOOTH

MIDEAST EMERGENCY RESPONSE ASSIST

ALL PARKSENSE SYSTEMS

3 ADDITIONAL GALLONS OF GAS



# 2024 JEEP GRAND CHEROKEE L LIMITED PLUS LUXURY 4X4 GCC 0Km

EURO 6

7 Сиденья

Зимний Пакет

Вентиляция и Подогрев Сидений

Рулевое Колесо с Подогревом

Боковые Зеркала с Подогревом

Электрорегулировка сидений с памятью позиций

Адаптивный круиз-контроль

Камера 360 градусов

Регулируемые режимы вождения (включая Зимний режим)

Премиум LED оптика

Панорамная Крыша

Стереосистема Alpine с 9 динамиками и сабвуфером

Система удержания в полосе

Зеркало с камерой заднего вида

Система помощи при спуске

Система экстренного торможения

Система контроля слепых зон

Система Start/Stop

Камера Наблюдения Внутри Салона

Кондиционер для пассажиров на заднем ряду

Контроль скорости

Бесключевой доступ

Бесключевой старт

Дистанционный запуск двигателя

10,1-дюймовый сенсорный дисплей

Беспроводная зарядка для телефона

Задние Шторки

Система Мониторинга Слепых Зон

Apple CarPlay & Android Auto

# 2024 JEEP GRAND CHEROKEE L LIMITED PLUS LUXURY 4X4 GCC 0Km

\* الأداء:

ناقل حركة أوتوماتيكي ب 8 سرعات

عدد الأسطوانات: 6 أسطوانات

سعة المحرك: 3.6 ليتر

العزم: 352 نيوتن.متر

عدد الأحصنة: 293 حصان

دفع رباعي 4X4

\* المواصفات الإضافية:

7 مراتب

OFF ROAD PAGES

رادار

فتحة سقف بانوراما

مثبت السرعة التكميلي

محدد سرعة الكتروني

نظام مكابح متقدم مع الفرامل التلقائية

نظام البطارية المزدوجة للبدء والتوقف

كاميرا مراقبة المقصورة

كاميرا بزاوية 360

نظام صوتي متقدم من Alpine

وحدة تكييف خلفية منفصلة

كاميرا المرآة الداخلية

خاصية تبريد وتدفئة المراتب

خاصية تدفئة المقود

خاصية تسخين المرايا الجانبية

# 2024 JEEP GRAND CHEROKEE L LIMITED PLUS LUXURY 4X4 GCC 0Km

حساسات متقدمة

التشغيل عن بعد

تثبيت مسار

خاصية تنظيف الكاميرا

الوضعيات المتعددة للقيادة

دخول بصمة

خاصية الكشف عن النقطة العمياء

مراتب كهربائية متعددة الوضعيات مع خاصية الذاكرة

شاشة تعمل باللمس قياس حجم 10.1 بوصة

اللغة عربية

نظام الملاحة وتحديد المواقع

آمر صوتي متكامل مع بلوتوث

دبّة كهرباء

مخارج طاقة كهربائية متعددة

شاحن هاتف لاسلكي امامي

ستائر خلفية

إنارة متقدمة

عازل حراري خارجي للزجاج

عازل للضجيج الخارجي

ابل كاربلاي + اندرويد أوتو

# AUTOMAX®

The Boutique Of Muscle Cars, Truck Fanatics & German Automotive Experts.



نتكلم اللغة العربية

WE SPEAK ENGLISH

ON PARLE LE FRANCAIS

Nosotros hablamos español

мы говорим по-русски

biz o'zbek tilida

gaplashamiz

हम हिंदी बोलते हैं



[automaxgroup.me](http://automaxgroup.me)



[automax group](https://www.youtube.com/automaxgroup)



[automax.dxb](https://www.snapchat.com/add/automax.dxb)



[Automax\\_LLC](https://www.telegram.com/Automax_LLC)



[+971 50 602 7200](https://www.whatsapp.com/+971506027200)



[automax.dxb](https://www.instagram.com/automax.dxb)



[automax.dxb](https://www.facebook.com/automax.dxb)



[automax.dxb](https://www.tiktok.com/automax.dxb)



[automax\\_dxb](https://www.x.com/automax_dxb)



[automax group L.L.C](https://www.linkedin.com/company/automax-group-l-l-c)

New Auto Market - Dubai - United Arab Emirates



Directions