





Jeep

AEAUH





GRAND CHEROKEE

4x4

Jeep

AUTOMAX  
AUTOMAX AB Tel. No. 02000 766 52 72 78

GRAND CHEROKEE



Jeep

**AUTOMAX**  
AUTOMAX.AE Tel: 04-3205860 / Mob: 05 277 277 07

4x4

LIMITED











Jeep

AIRBAG

Top View

2

1

3

MUTE

MAX

REAR

OFF

1

AUX

2

12V DC



Navigation and media control icons: a left arrow, a menu icon, an up arrow, and a down arrow.

Steering wheel multifunction controls:  
Top row: Left arrow, OK button, Right arrow  
Middle row: Left arrow, OK button, Right arrow  
Bottom row: Downward arrow  
Right side buttons: Green phone handset icon, Speaker icon, Red phone handset icon

Jeep

AIRBAG  
P

ep

AG



SET+



CANC



RES



SET-

N

0 km/h P

92°F

Key Fob  
has Left  
the Vehicle



27 km



0 km/h P 88°F

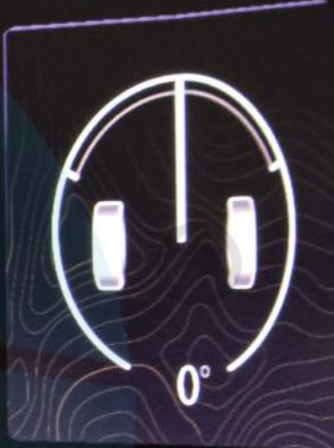
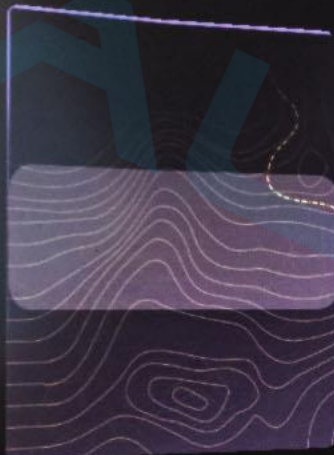

Press OK to Select

Hold OK to Edit

32 km

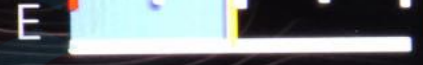

--

4. Off Road

0 km/h P

88°F

AUTO

Automatic Full

Time 4WD

Adapts to

Road Conditions



RPM X 1000

Terrain Status

32 km

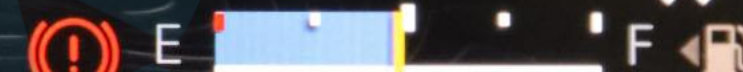

--

4. Off Road

0 km/h P

88°F

**AUTO**

Automatic Full

Time 4WD

Adapts to  
Road Conditions



**Terrain Status**

32 km



--

4. Off Road

0 km/h P

88°F

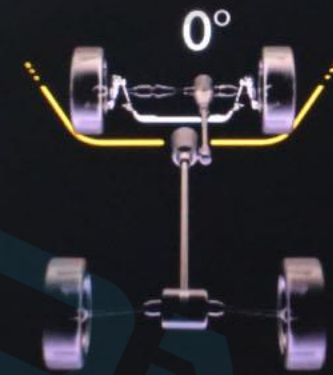

Vehicle Dynamics

32 km

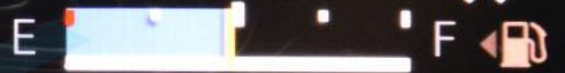



--

4. Off Road

0

km/h

P

88°F



3°



0°



RPM X 1000

Pitch & Roll

32 km



C



H



E



F



4. Off Road

0 km/h P



3°



0°



RPM X 1000

Pitch & Roll

32 km

C

H



E



OFF



OFF



OFF



OFF

Низ.



98°  
НАРУЖН.

4:05

FM STAR FM



Передн.

Задний



# Check Entire Surroundings



Top View

Rear View

The main display area is split into two panels. The left panel, labeled 'Top View', shows a top-down perspective of a car on a road. The right panel, labeled 'Rear View', shows a rear-facing camera view of the road. Hand gesture icons are overlaid on both panels, with numbers 1, 2, and 3 indicating different gestures. In the Top View, gesture 1 is a hand with fingers spread, gesture 2 is a hand with fingers curled, and gesture 3 is a hand with the index finger pointing. In the Rear View, gesture 1 is a hand with fingers spread, gesture 2 is a hand with fingers curled, and gesture 3 is a hand with the index finger pointing. A white arrow points upwards in the center of the Rear View panel.



LO | | 36° OUT 4:28 FM ARABIYA | LO

Front Rear

2 2

Heat Heat

Vent Vent

1 1

Max A/C A/C Max Rear

3 3

Sync Off < 1 2 3 4 5 6 7 > Auto

MUTE SCREEN OFF

VOL ENTER

REAR OFF AUTO

LO



36°  
OUT

4:37

FM ARABIYA



LO



### Selectable Tire Fill Alert

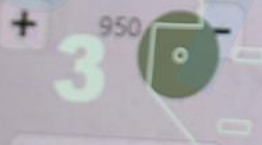

Apply and Save Preset

Presets



E  
A



Vehicle



LO



36°  
OUT

4:37

FM ARABIYA



LO

Vehicle Dynamics

2



Steering Angle:  
0°



2

Accessory Gauges

Transfer Case:  
4WD HIGH

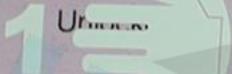

1

Pitch & Roll

Selec-Terrain

Forward Facing Camera

3

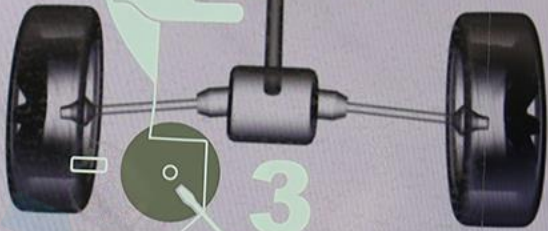

3

4WD HIGH

55°22'03" E

25°10'06" N

Altitude -19 m

AUTO



E



Vehicle





LO



36°  
OUT

4:38

FM ARABIYA



LO

Vehicle Dynamics

2

Accessory Gauges

Pitch & Roll

Selec-Terrain

Forward Facing Camera

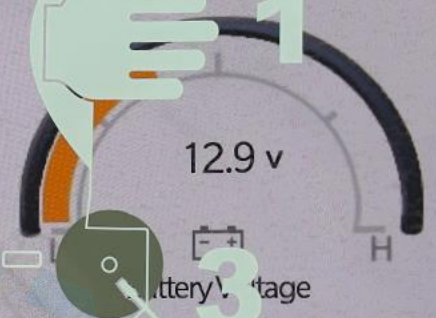

4WD  
HIGH

55°22'03" E 25°10'06" N

Altitude -19 m

AUTO



E  
A



Vehicle



LO

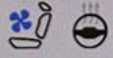

36°  
OUT

4:30

FM ARABIYA



LO

Favorites

Recent

Categories

All

2

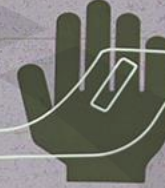

2



eco-Coaching

1



Comfort



Off Road Pages



1

3



3



E  
A



Apps

Vehicle Dynamics **2**

Accessory Gauges

Pitch & Roll

Selec-Terrain

Forward Facing Camera

4WD HIGH 55°22'03" E 25°10'06" N Altitude -19m AUTO

Низ.

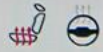

98°  
НАРУЖН.

4:04

FM STAR FM



Низ.

Передн.

Задний

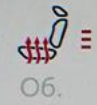

Об.



Вен



Пер. обдув



Об.



Вен

Макс. A/C

A/C

Максим.

Задний

Синхр.

Off



1

2

3

4

5

6

7



Авт.



Главная



M/мед



Comfort



Nav



Тел.



Автом.



Прил.

Последние Категории Все

Vertical menu with icons and a slider:

- 
- 
- 
- Синх.

Main grid of application icons:

- Вент. водит.
- Вент. пасс.
- Допол. кабель
- Камера зад. вида
- Камера круг. обзо...
- Комфорт

Низ.

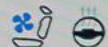

98°  
НАРУЖН.

4:01

FM STAR FM



Низ.

Избранные

Последние

Категории

Все

А - Я

Я - А



Автом.



Вент. водит.



Вент. пасс.



Допол.  
кабель



Затемнение  
зеркала



Камера  
зад. вида



Камера  
круг. обзо...



Комфорт



Главная



М/мед



Comfort



Nav



Тел.



Автом.



Прил.

Низ.



98°  
НАРУЖН.

4:02

FM STAR FM



Низ.

Динамика  
автомобиля

Вспомог.  
приборы

Попер.  
перемещения

Selec-Terrain

Камера  
переднего  
обзора

Угол поворота  
рулевого колеса:  
0°

Transfer Case:  
Разблокирована

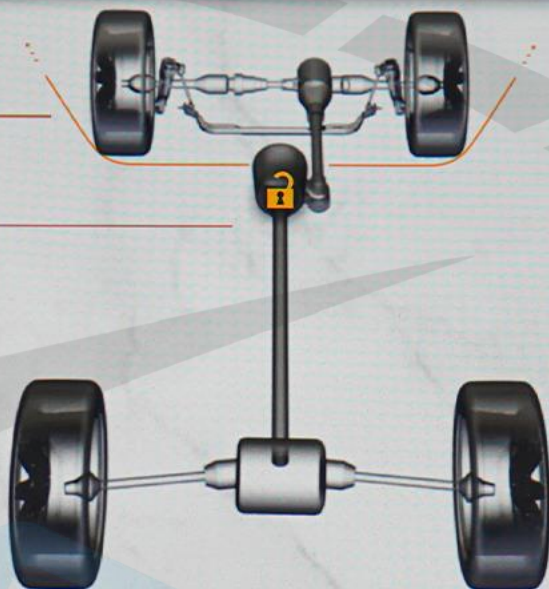

4WD HIGH

55°22'13" E

25°10'20" N

Высота -4 m

SPORT



Главная



М/мед



Comfort



Nav



Тел.



Автом.



Прил.

Низ.



98°  
НАРУЖН.

4:02

FM STAR FM



Низ.

Динамика  
автомобиля

Вспомог.  
приборы

Попер.  
перемещения

Selec-Terrain

Камера  
переднего  
обзора



4WD HIGH

55°22'13" E

25°10'20" N

Высота -4 m

SPORT



Главная



М/мед



Comfort



Nav



Тел.



Автом.



Прил.



Низ.



98°  
НАРУЖН.

4:02

FM STAR FM



Низ.

Динамика  
автомобиля

Вспомог.  
приборы

Попер.  
перемещения

Selec-Terrain

Камера  
переднего  
обзора



0°

Наклон

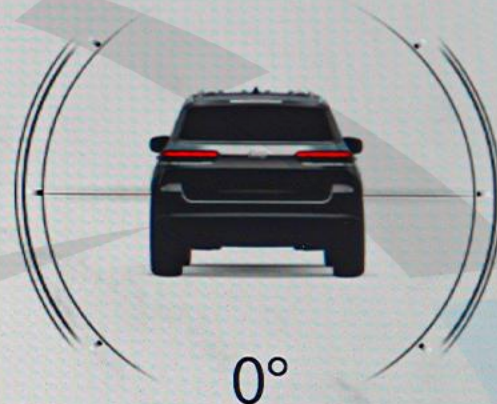

0°

Крен

4WD HIGH

55°22'13" E

25°10'20" N

Высота -4 m

SPORT



Главная



М/мед



Comfort



Nav



Тел.



Автом.



Прил.

Низ.



98°  
НАРУЖН.

4:02

FM STAR FM



Низ.

Динамика  
автомобиля

Вспомог.  
приборы

Попер.  
перемещения

Selec-Terrain

Камера  
переднего  
обзора



4WD HIGH

55°22'13" E

25°10'20" N

Высота -4 m

SPORT



Главная



М/мед



Comfort



Nav



Тел.



Автом.



Прил.

MUTE

AC

OFF

OFF

OFF

OFF

SCREEN

Низ.

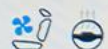

98°  
НАРУЖН.

4:02

FM STAR FM



Низ.

Динамика  
автомобиля

Вспомог.  
приборы

Попер.  
перемещения

Selec-Terrain

Камера  
переднего  
обзора



4WD HIGH

55°22'13" E

25°10'20" N

Высота -4 м

SNOW



Главная



М/мед



Comfort



Nav



Тел.



Автом.



Прил.

MUTE



SCREEN  
OFF

Низ.



98°  
НАРУЖН.

4:02

FM STAR FM



Низ.

Динамика  
автомобиля

Вспомог.  
приборы

Попер.  
перемещения

Selec-Terrain

Камера  
переднего  
обзора

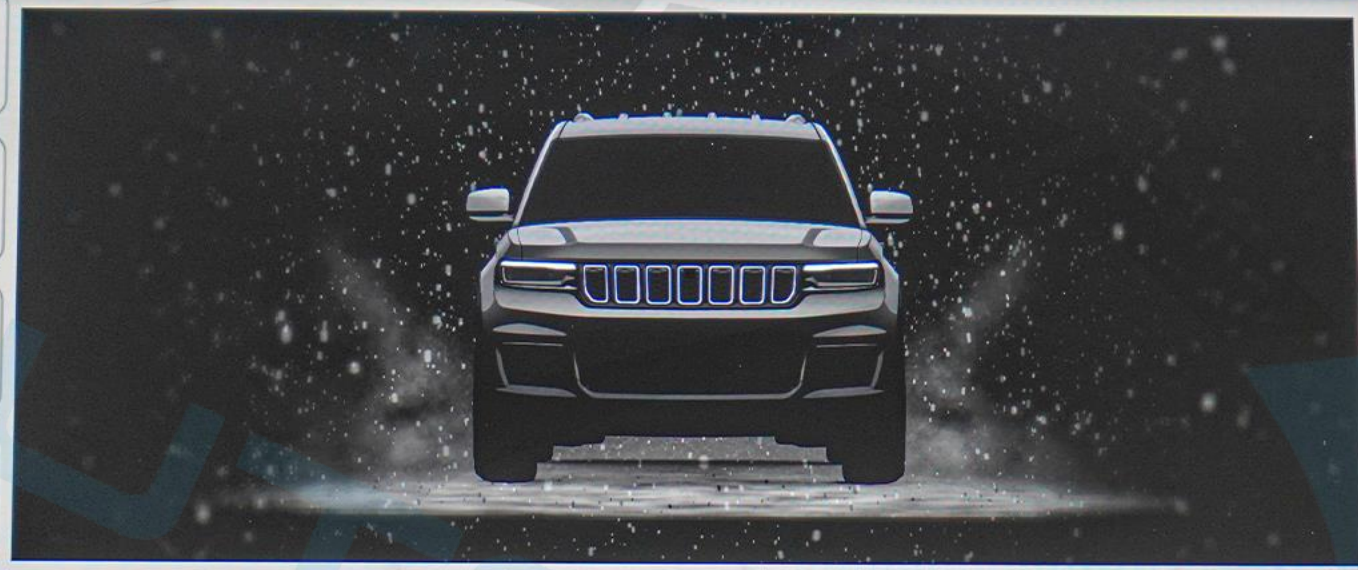

4WD HIGH

55°22'13" E

25°10'20" N

Высота -4 m

SNOW



Главная



М/мед



Comfort



Nav



Тел.



Автом.



Прил.

MUTE



SCREEN  
OFF

OFF OFF OFF OFF OFF OFF OFF OFF

22° 24° خارج 7:20 97.30 FM 22°



التطبيقات المركبة الهاتف Nav Comfort الوسائط الرئيسية



MUTE SCREEN OFF



23° 24° خارج ٦:٢٢ 97.30 FM 23°

2 غير غير FM

1

4 أنقر للحفظ 3 أنقر للحفظ 2 سر حفظ 1 للحفظ كل المُسبقة

6 شارع

بحث شارع ند الحمر

1

- التطبيقات
- المركبة
- الهاتف
- Nav
- Comfort
- الوسائط
- الرئيسية

٢٢° ٢٤° خارج ٦:٢٣ 97.30 FM ٢٢°

ديناميكيات  
المركبة

2

زاوية التوجيه  
0°

ملحقات  
المقاييس

انحدار و  
التفاف

Selec-Terrain

الكاميرا الأمامية

4WD  
HIGH

55°22'07" E

25°10'14" N

ارتفاع -23 m

SNOW



التطبيقات



المركبة



الهاتف



Nav



Comfort



الوسائط



الرئيسية

OFF OFF OFF OFF OFF

٢٢° ٢٤° خارج ٦:٢٣ 97.30 FM ٢٢°

ديناميكيات المركبة

ملحقات المقاييس

انحدار و التفاف

Selec-Terrain

الكاميرا الأمامية



4WD HIGH 55°22'07" E 25°10'14" N ارتفاع -23 m SNOW

التطبيقات

المركبة

الهاتف

Nav

Comfort

الوسائط

الرئيسية

MUTE

SCREEN



OFF OFF OFF OFF OFF OFF

٢٢° ٢٤° خارج ٦:٢٣ 97.30 FM ٢٢°

ديناميكيات المركبة 2

ملحقات المقاييس

انحدار و التفاف

Selec-Terrain

الكاميرا الأمامية

0° انحدار

0° التفاف

4WD HIGH 55°22'07" E 25°10'14" N ارتفاع -23 m SNOW

التطبيقات المركبة الهاتف Nav Comfort الوسائط الرئيسية

MUTE SCREEN OFF



Home



Media



Comfort



Nav



Phone



Vehicle



Apps

MUTE



SCREEN OFF

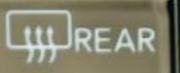

OFF



AUTO

A/C



SAND/MUD  
SNOW  
AUTO  
SPORT



P

R

FYU

MAX

REAR

OFF

AUTO

A/C



1



AUX



2



12V DC



SAND/MUD  
SNOW  
AUTO  
SPORT

**P** R N D



VOL  
REAR OFF AUTO A/C  
AUX  
ENTER

1 AUX 2 12V DC

SAND/MUD  
SNOW  
AUTO  
SPORT

P R N D

Handbrake

Cup holders



115 V AC  
150 W













Central control panel on the sun visor with the following controls:

- Left side: Headlight control with an icon of a headlight and a sliding switch.
- Top center: A car icon.
- Middle: A sliding switch for "OFF" and "ON" with a car icon.
- Right side: A red "SOS" button with a telephone handset icon.
- Bottom row (left to right):
  - "OPEN AUTO CLOSE" button with a car icon.
  - "TILT VENT DOWN" button with a car icon.
  - "OPEN AUTO CLOSE" button with a car icon.

**AIRB**

Warning label with the following icons:

- A red circle with a diagonal line through it, containing a car seat icon.
- A hand icon pointing towards a car seat.
- A car seat icon with a red arrow pointing to the headrest area.





(P)68377094AA

UP











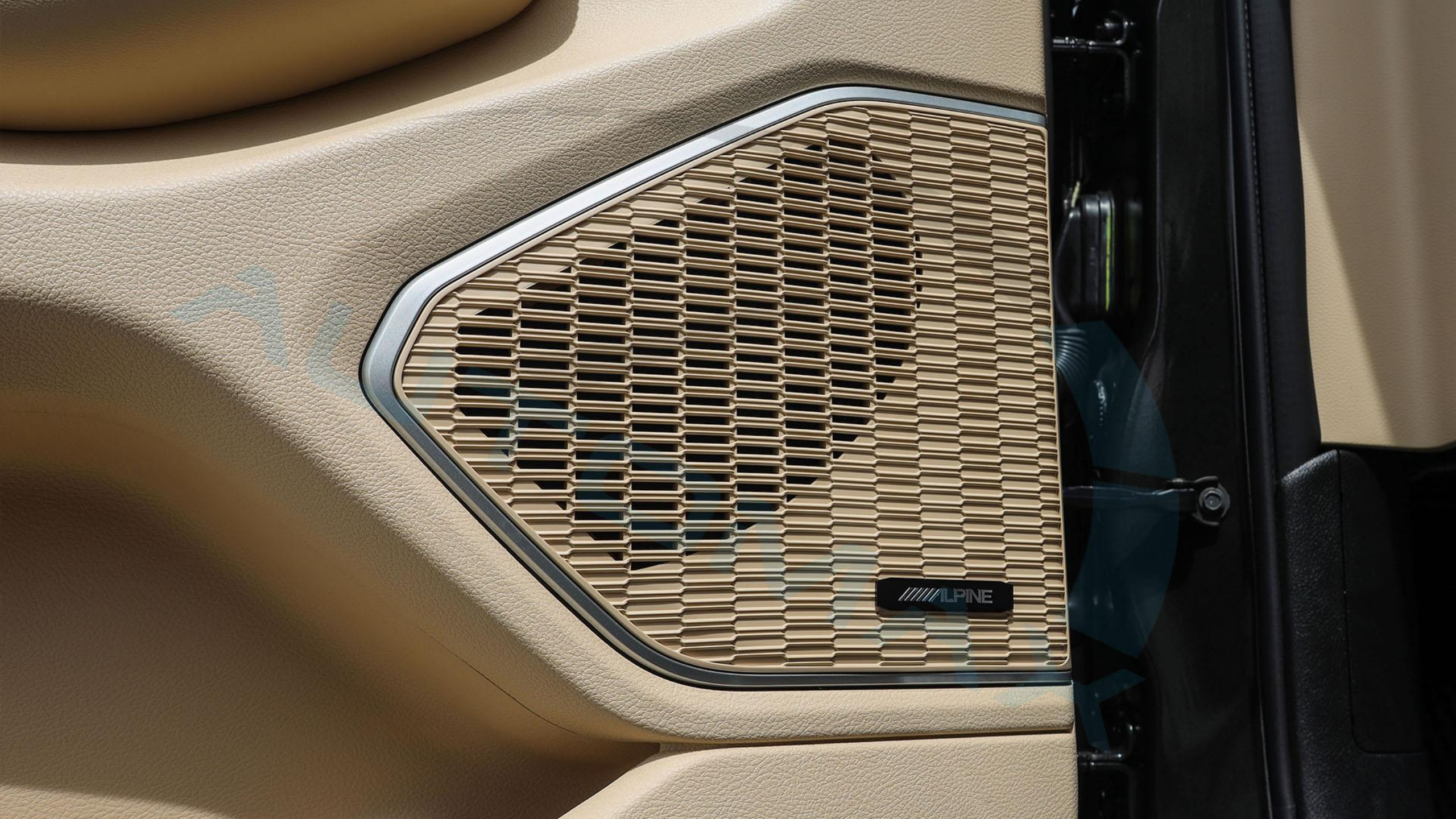

//////ALPINE







12V DC











ALU

13AKC39010X LHT





AUAU







GRAND CHEROKEE



GRAND CHEROKEE







لمشاهدة صورة السيارة بزاوية 360 درجة إضغط على الصورة أعلاه

Для просмотра автомобиля в формате 360°, пожалуйста, нажмите на фото выше.

To view the 360° degree please press on the picture above

# 2024 JEEP GRAND CHEROKEE LIMITED PLUS LUXURY 4X4 GCC 0Km

Бренд: JEEP

Категория: GRAND CHEROKEE

Модель: LIMITED PLUS LUXURY

Год: 2024

Километров: 0 км

Двери: 4

Цвет: Серый

Цилиндр: 6

Лошадиные силы: 293 HP

Трансмиссия: Автоматическая

Топливо: Бензин

Производство: 2024

Brand: JEEP

Category: GRAND CHEROKEE

Model: LIMITED PLUS LUXURY

Year: 2024

Kilometers: 0Km

Doors: 4 Doors

Color: Rocky Mountain

Cylinder: 6 Cylinders

Horsepower: 293 HP

Transmission: Automatic

GCC Specifications

Fuel: Gasoline

الماركة: جيب

الفئة: جرانند شيروكي

الموديل: ليمتد بلس لكشري

السنة: 2024

كيلومترات: 0 كم

عدد الأبواب: أربعة ابواب

اللون: صخري

عدد الاسطوانات: 6 أسطوانات

عدد الأحصنة: 293 حصان

نوع النقل : نقل أوتوماتيكي

المواصفات الإقليمية: الخليجية

نوع الوقود: بنزين



# 2024 JEEP GRAND CHEROKEE LIMITED PLUS LUXURY 4X4 GCC 0Km

CAPRI LEATHERETTE W/AXIS II SEATS

GLOBAL BLACK/WICKER BEIGE

MIDDLE EAST EQUIPMENT GROUP

EMEA EQUIPMENT GROUP

LUXURY TECH GROUP II

SMOKER'S GROUP

AUX BATTERY

ADVANCED BRAKE ASSIST

ANTI-LOCK 4-WHEEL FNC DISC BRAKES

VENTILATED FRONT SEATS

CARGO COMPARTMENT COVER

REMOVABLE ASH TRAY

8-SPD AUTO 8HP50 TRANS (BUY)

3.6L V6 24V VVT ENGINE UPG I W/ESS

LIGHT TINT SOLAR CONTROL GLASS

WINDOW SHADES, 2ND ROW, MANUAL

AUTO DIM EXTERIOR DRIVER MIRROR

RRVIEW AUTODIM DIGITAL DISPLAY MIRRO

DUAL-PANE PANORAMIC SUNROOF

PASSIVE ENTRY-FRT/RR DOORS, LIFTGATE

240 KPH PRIMARY SPEEDOMETER

RAIN SENSITIVE WINDSHIELD WIPERS

REAR BACK UP CAMERA WASHER

CIGAR LIGHTER

GPS NAVIGATION

GPS ANTENNA INPUT

ACTIVE NOISE CONTROL SYSTEM

EXT. MIRRORS W/SUPPLEMENTAL SIGNALS

EXTERIOR MIRRORS W/ARABIC LETTERING

EXTERIOR MIRRORS W/MEMORY

# 2024 JEEP GRAND CHEROKEE LIMITED PLUS LUXURY 4X4 GCC 0Km

MEMORY STEERING COLUMN

HEATED EXTERIOR MIRRORS

GLOSS BLACK EXTERIOR MIRRORS

MANUAL FOLDING EXTERIOR MIRRORS

REAR LED FOG LAMPS

LED DAYTIME RUNNING LAMPS- LOW BEAM

PEDESTRIAN/CYCLIST EMERGENCY BRAKING

FRONT LICENSE PLATE BRACKET

EXPORT EMISSIONS

EURO STAGE 6B EMISSIONS

ENGINE OIL COOLER

TRANSMISSION HEATER

ROCKY MOUNTAIN PEARL COAT

ALL RADIO EQUIPPED VEHICLES

9 AMPLIFIED SPEAKERS W/SUBWOOFER

506 WATT AMPLIFIER

APPLE CARPLAY

DISASSOCIATED TOUCHSCREEN DISPLAY

WIRELESS CHARGING PAD

GOOGLE ANDROID AUTO

USB HOST FLIP

BODY COLOR SHARK FIN ANTENNA

10.1" TOUCHSCREEN DISPLAY

DIGITAL AUDIO BROADCASTING

INTEGRATED CENTER STACK RADIO

ALL R1 HIGH RADIOS

EXPORT TUNED SUSPENSION

POWER TILT/TELESCOPE STEERING COLUMN

FULL SIZE SPARE TIRE

265/50R20 PERFORMANCE A/S TIRES

# 2024 JEEP GRAND CHEROKEE LIMITED PLUS LUXURY 4X4 GCC 0Km

PIRELLI BRAND TIRES

UCONNECT 5 NAV w 10.1" DISP(ROW+DAB)

REST OF WORLD RADIO COUNTRIES

20X8.5 MACHINED/PAINTED ALUM WHEEL

ALL ALUMINUM WHEELS

18" FULL SIZE STEEL SPARE WHEEL

SURROUND VIEW CAMERA SYSTEM

PARKSENSE FR/RR PARK ASSIST w/STOP

ARABIC LANGUAGE

INTEGRATED OFF-ROAD CAMERA

INTERSECTION COLLISION ASSIST SYSTEM

INTEGRATED VOICE COMMAND w/BLUETOOTH

ALL PARKSENSE SYSTEMS

3 ADDITIONAL GALLONS OF GAS



# 2024 JEEP GRAND CHEROKEE LIMITED PLUS LUXURY 4X4 GCS 0Km

EURO 6

Зимний Пакет

Вентиляция и Подогрев Сидений

Рулевое Колесо с Подогревом

Боковые Зеркала с Подогревом

Электрорегулировка сидений с памятью позиций

Адаптивный круиз-контроль

Камера 360 градусов

Регулируемые режимы вождения (включая Зимний режим)

Премиум LED оптика

Панорамная Крыша

Стереосистема Alpine с 9 динамиками и сабвуфером

Система удержания в полосе

Зеркало с камерой заднего вида

Система помощи при спуске

Система экстренного торможения

Система контроля слепых зон

Система Start/Stop

Контроль скорости

Бесключевой доступ

Бесключевой старт

Дистанционный запуск двигателя

10,1-дюймовый сенсорный дисплей

Беспроводная зарядка для телефона

Задние Шторки

Система Мониторинга Слепых Зон

R20"

Apple CarPlay & Android Auto

# 2024 JEEP GRAND CHEROKEE LIMITED PLUS LUXURY 4X4 GCC 0Km

\* الأداء:

ناقل حركة أوتوماتيكي ب 8 سرعات

عدد الأسطوانات: 6 أسطوانات

سعة المحرك: 3.6 ليتر

العزم: 352 نيوتن.متر

عدد الأحصنة: 293 حصان

دفع رباعي 4X4

\* المواصفات الإضافية:

OFF ROAD PAGES

رادار

فتحة سقف بانوراما

مثبت السرعة التكييفي

محدد سرعة الكتروني

نظام مكابح متقدم مع الفرامل التلقائية

نظام البطارية المزدوجة للبدء والتوقف

كاميرا بزاوية 360

نظام صوتي متقدم من Alpine

كاميرا المرآة الداخلية

خاصية تبريد وتدفئة المراتب

خاصية تدفئة المقود

خاصية تسخين المرايا الجانبية

# 2024 JEEP GRAND CHEROKEE LIMITED PLUS LUXURY 4X4 GCC 0Km

نظام الملاحة وتحديد المواقع  
حساسات متقدمة  
التشغيل عن بعد  
تثبيت مسار  
خاصية تنظيف الكاميرا  
الوضعيات المتعددة للقيادة  
دخول بصمة  
خاصية الكشف عن النقطة العمياء  
مراتب كهربائية متعددة الوضعيات مع خاصية الذاكرة  
شاشة تعمل باللمس قياس حجم 10.1 بوصة  
اللغة عربية

آمر صوتي متكامل مع بلوتوث  
دبّة كهرباء  
مخارج طاقة كهربائية متعددة  
شاحن هاتف لاسلكي امامي  
ستائر خلفية  
إنارة متقدمة  
عازل حراري خارجي للزجاج  
عازل للضجيج الخارجي  
جنوط قياس 20 بوصة  
ابل كاربلاي  
اندرويد أوتو

# AUTOMAX®

The Boutique Of Muscle Cars, Truck Fanatics & German Automotive Experts.



نتكلم اللغة العربية

WE SPEAK ENGLISH

ON PARLE LE FRANCAIS

Nosotros hablamos español

мы говорим по-русски

biz o'zbek tilida

gaplashamiz

हम हिंदी बोलते हैं



automaxgroup.me



automax group



automax.dxb



Automax\_LLC



+971 50 602 7200



automax.dxb



automax.dxb



automax.dxb



automax\_dxb



automax group L.L.C

New Auto Market - Dubai - United Arab Emirates



Directions