



Jeep

GRAND CHEROKEE





Jeep

GRAND CHEROKEE





Jeep

AUTOMAX
AUTOMAX 4x4 Tel: 04 - 3205660 / Mob: 95 277 277 07

4x4

LIMITED



Jeep

AUTOMAX
AUTOMAX.COM TEL: (41) 2280888 FAX: (41) 277 277 27

LIMITED

GRAND CHEROKEE







Jeep

AIRBAG

Top View

2

1

3

MUTE

MAX

REAR

OFF

1

AUX

2

12V DC



Navigation and lighting control icons: a double-headed arrow, a headlight icon, and up/down arrows.

Steering wheel multifunction buttons: left arrow, OK, right arrow, left arrow, OK, right arrow, downward arrow, green phone icon, media control icon, red phone icon.

Jeep

AIRBAG
R

ep

AG



SET+



CANC



RES



SET-

0 km/h P 88°F

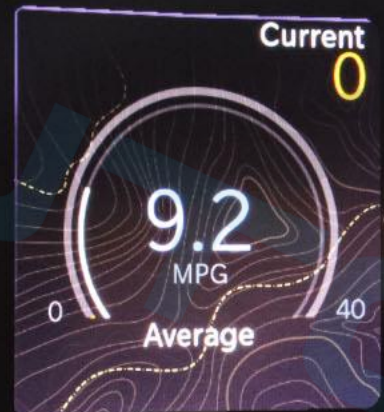
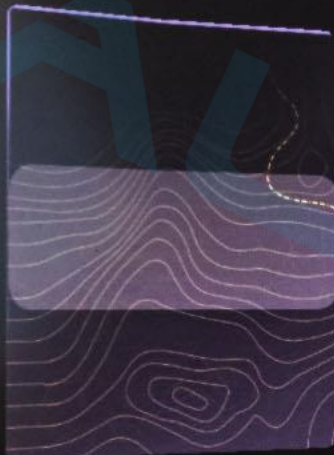

FM 102
FM 102.00 MH

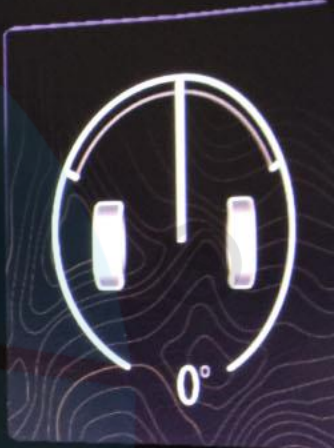

Press OK to Select

Hold OK to Edit

32 km



--

4. Off Road

0 km/h P

88°F

AUTO

Automatic Full

Time 4WD

Adapts to

Road Conditions



Terrain Status

32 km



--

4. Off Road

0 km/h P

88°F

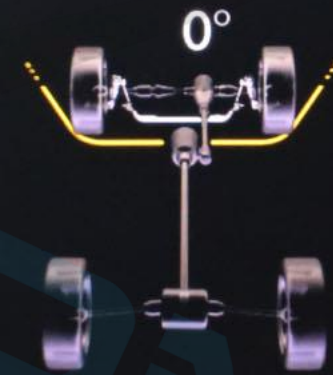

Vehicle Dynamics

32 km

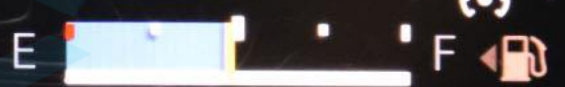

--

4. Off Road

0

km/h

P

88°F



3°



0°



RPM X 1000

Pitch & Roll

32 km



C

H



E

F





OFF



OFF



OFF



OFF

Низ.



98°
НАРУЖН.

4:05

FM STAR FM



Передн.

Задний



Check Entire Surroundings



Top View

Rear View

The main display area is split into two panels. The left panel, labeled 'Top View', shows a top-down perspective of a car on a road. The right panel, labeled 'Rear View', shows a rearward perspective of the same car. Hand gesture icons are overlaid on both panels: a hand with index finger pointing up (labeled '1'), a hand with index finger pointing right (labeled '2'), and a hand with index finger pointing down (labeled '3'). A white line connects these gestures between the two views. At the bottom of the main display, there are five icons: a car with a red background and a downward arrow, a car with an upward arrow, a car with an umbrella, a car with a downward arrow, and a car with a camera icon.



LO



36°
OUT

4:37



ARABIYA



LO



Selectable Tire Fill Alert

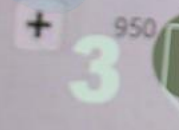

+ 950

950

950

+ 950

950

950

Apply and Save Preset

Presets



E
A



Vehicle



MUTE



LO



36°
OUT

4:37

FM ARABIYA



LO

Vehicle Dynamics

2



Steering Angle:
0°



2

Accessory Gauges

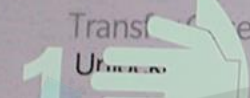

Transmission

1



1

Pitch & Roll

Selec-Terrain

Forward Facing Camera

3

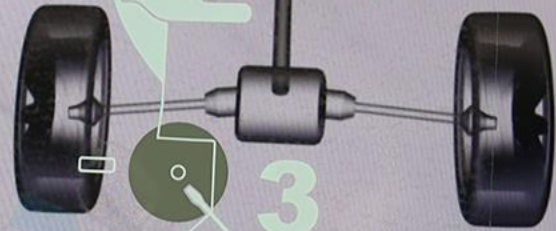

3

4WD
HIGH

55°22'03" E

25°10'06" N

Altitude -19m

AUTO



E
A



Vehicle



LO



36°
OUT

4:38

FM ARABIYA



LO

Vehicle Dynamics

2

Accessory Gauges

Pitch & Roll

Selec-Terrain

Forward Facing Camera

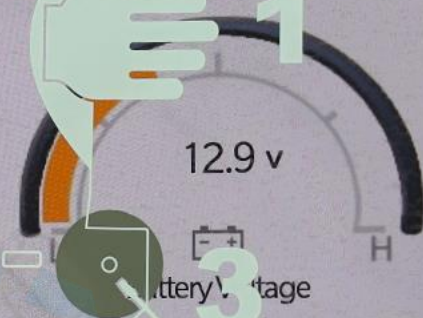
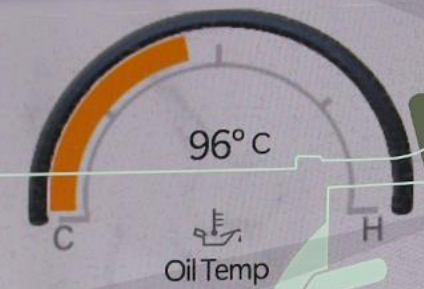

4WD
HIGH

55°22'03" E 25°10'06" N

Altitude -19 m

AUTO



E
A



Vehicle



LO

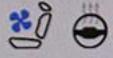

36°
OUT

4:30

FM ARABIYA



LO

Favorites

Recent

Categories

All

2

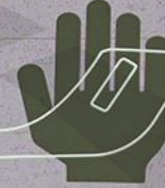

2



eco-
Coaching

1



fort



Off Road
Pages



1

3



3



E
A



Apps

Vehicle Dynamics **2**

Accessory Gauges

Pitch & Roll

Selec-Terrain

Forward Facing Camera

4WD HIGH 55°22'03" E 25°10'06" N Altitude -19m AUTO

Низ.

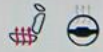

98°
НАРУЖН.

4:04

FM STAR FM



Низ.

Передн.

Задний

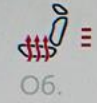

Об.



Вен



Пер. обдув



Об.



Вен

Макс. А/С

A/C

Максим.

Задний

Синхр.

Off



1

2

3

4

5

6

7



Авт.



Главная



М/мед



Comfort



Nav



Тел.



Автом.



Прил.

Последние Категории Все

Vertical menu with icons and a slider:

-
-
-
- Синх.

Main grid of application icons:

- Вент. водит.
- Вент. пасс.
- Допол. кабель
- Камера зад. вида
- Камера круг. обзо...
- Комфорт

Низ.

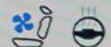

98°
НАРУЖН.

4:01



STAR FM



Низ.

Избранные

Последние

Категории

Все

А - Я

Я - А



Автом.



Вент. водит.



Вент. пасс.



Допол.
кабель



Затемнение
зеркала



Камера
зад. вида



Камера
круг. обзо...



Комфорт



Главная



М/мед



Comfort



Nav



Тел.



Автом.



Прил.

Низ.



98°
НАРУЖН.

4:02

FM STAR FM



Низ.

Динамика
автомобиля

Вспомог.
приборы

Попер.
перемещения

Selec-Terrain

Камера
переднего
обзора

Угол поворота
рулевого колеса:
0°

Transfer Case:
Разблокирована

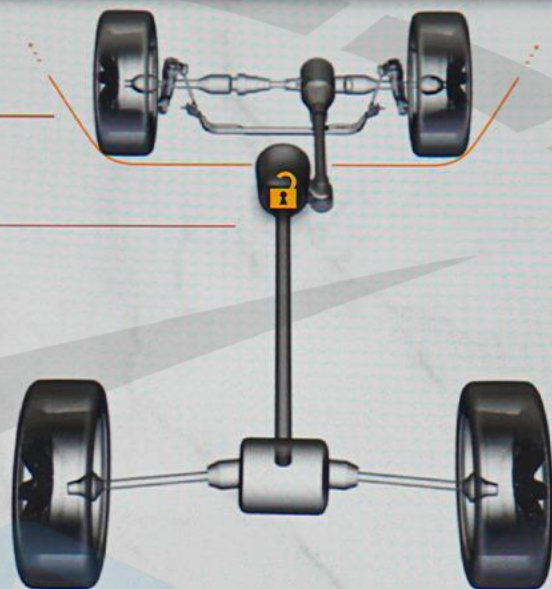

4WD HIGH

55°22'13" E

25°10'20" N

Высота -4 m

SPORT



Главная



М/мед



Comfort



Nav



Тел.



Автом.



Прил.

Низ.



98°
НАРУЖН.

4:02

FM STAR FM



Низ.

Динамика
автомобиля

Вспомог.
приборы

Попер.
перемещения

Selec-Terrain

Камера
переднего
обзора

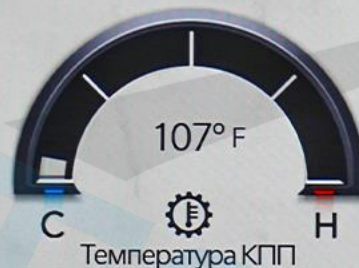

4WD HIGH

55°22'13" E

25°10'20" N

Высота -4 m

SPORT



Главная



М/мед



Comfort



Nav



Тел.



Автом.



Прил.

Низ.



98°
НАРУЖН.

4:02

FM STAR FM



Низ.

Динамика
автомобиля

Вспомог.
приборы

Попер.
перемещения

Selec-Terrain

Камера
переднего
обзора



0°

Наклон

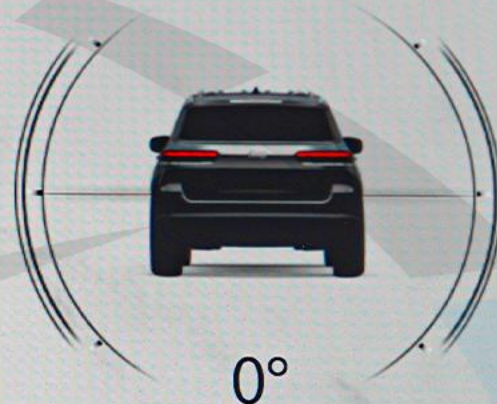

0°

Крен

4WD HIGH

55°22'13" E

25°10'20" N

Высота -4 m

SPORT



Главная



М/мед



Comfort



Nav



Тел.



Автом.



Прил.

Низ.



98°
НАРУЖН.

4:02

FM STAR FM



Низ.

Динамика
автомобиля

Вспомог.
приборы

Попер.
перемещения

Selec-Terrain

Камера
переднего
обзора



4WD HIGH

55°22'13" E

25°10'20" N

Высота -4 m

SPORT



Главная



М/мед



Comfort



Nav



Тел.



Автом.



Прил.

Низ.

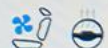

98°
НАРУЖН.

4:02

FM STAR FM



Низ.

Динамика
автомобиля

Вспомог.
приборы

Попер.
перемещения

Selec-Terrain

Камера
переднего
обзора



4WD HIGH

55°22'13" E

25°10'20" N

Высота -4 м

SNOW



Главная



М/мед



Comfort



Nav



Тел.



Автом.



Прил.

MUTE



SCREEN
OFF

Низ.



98°
НАРУЖН.

4:02

FM STAR FM



Низ.

Динамика
автомобиля

Вспомог.
приборы

Попер.
перемещения

Selec-Terrain

Камера
переднего
обзора

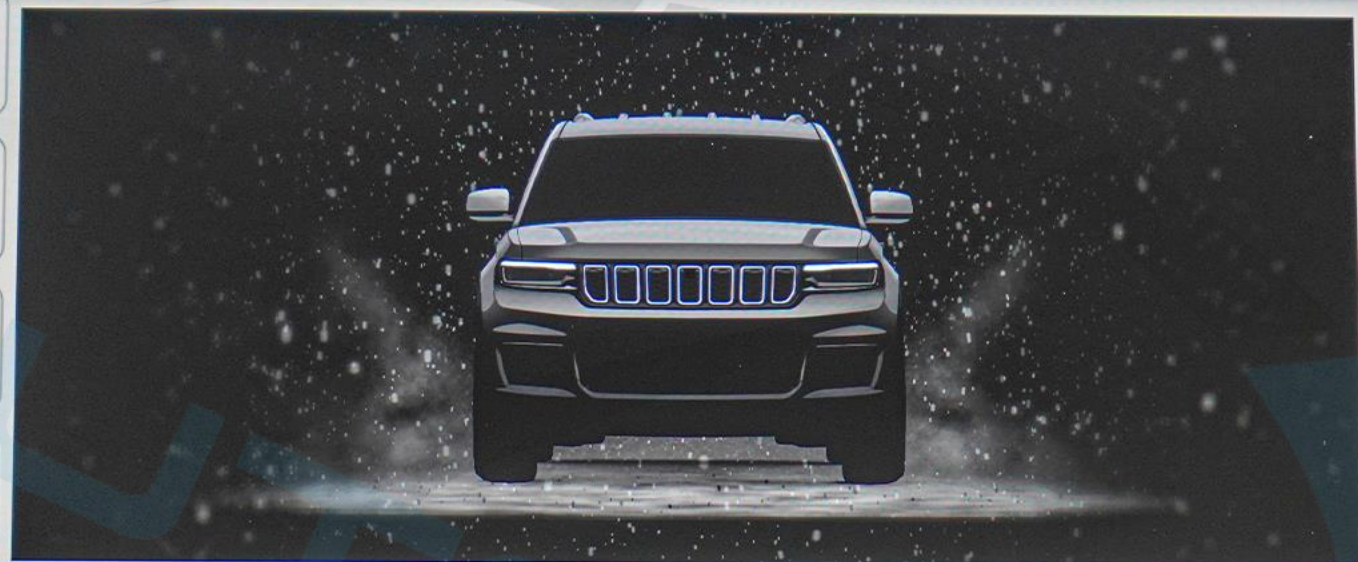

4WD HIGH

55°22'13" E

25°10'20" N

Высота -4 m

SNOW



Главная



М/мед



Comfort



Nav



Тел.



Автом.



Прил.

MUTE



SCREEN
OFF

OFF OFF OFF OFF OFF OFF OFF OFF



التطبيقات المركبة الهاتف Nav Comfort الوسائط الرئيسية

MUTE SCREEN OFF



2 غير غير FM

1

4 أنقر للحفظ 3 أنقر للحفظ 2 سر حفظ 1 للحفظ كل المُسبقة

6 شارع

بحث شارع ند الحمر

1

٢٢° ٢٤° خارج ٦:٢٣ 97.30 FM ٢٢°

ديناميكيات
المركبة

2



زاوية التوجيه
0°

ملحقات
المقاييس

انحدار و
التفاف

Selec-Terrain

الكاميرا الأمامية

1



حالة التعليق

3

4WD
HIGH

55°22'07" E

25°10'14" N

ارتفاع -23 m

SNOW

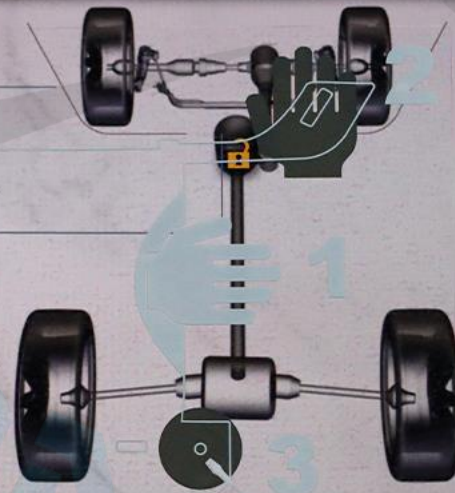

التطبيقات



المركبة



الهاتف



Nav



Comfort



الوسائط



الرئيسية

OFF OFF OFF OFF OFF

٢٢° ٢٤° خارج ٦:٢٣ 97.30 FM ٢٢°

ديناميكيات المركبة

ملحقات المقاييس

انحدار و التفاف

Selec-Terrain

الكاميرا الأمامية



4WD HIGH 55°22'07" E 25°10'14" N ارتفاع -23 m SNOW

التطبيقات

المركبة

الهاتف

Nav

Comfort

الوسائط

الرئيسية

MUTE

SCREEN



Home



Media



Comfort



Nav



Phone



Vehicle



Apps

MUTE



SCREEN OFF

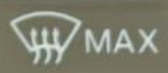

OFF



AUTO

A/C



MAX

REAR

OFF

AUTO

A/C



1



AUX



2



12V DC



SAND/MUD
SNOW
AUTO
SPORT

P R N D

SAND/MUD
SNOW
AUTO
SPORT



P R N D





115 V AC
150 W















ALPINE





12V DC









إسم الصانع والاسم التجاري للمركبة:
FCA US LLC Jeep Grand Cherokee

سنة الموديل: 2023
سعة المحرك: 2.0 L

نوع الدفع: دفع رباعي
نوع الحركة: اوتوماتيك
Transmission: Automatic

نوع المركبة: شاحنة خفيفة
نوع الهيكل: سيارة متعددة الأغراض
Vehicle Type: Light Truck
Body Style: SUV

Fuel Economy (Km/L)

اقتصاد الوقود (كم/لتر)

12.3

Excellent +

ممتاز +

Excellent

ممتاز

Very Good

جيد جداً

Good

جيد

Average

متوسط

Poor

سيئ

Very Poor

سيئ جداً



نوع الوقود:
بنزين ٩٥

Fuel Type:
Gasoline 95

FE02667/2022



إزالة أو تغطية أو العبث بهذا البطاقة قبل البيع يعرضك للملاحقة القانونية
The removal, covering or damaging of this label before sale is punishable by law





GRAND

PIRELLI

SCORPION VERDE

Jeep

265/55R18

DOT 11W KP7 RS42 Q122

MADE IN ITALY





لمشاهدة صورة السيارة بزاوية 360 درجة إضغط على الصورة أعلاه

Для просмотра автомобиля в формате 360°, пожалуйста, нажмите на фото выше.

To view the 360° degree please press on the picture above

2023 JEEP GRAND CHEROKEE LIMITE PLUS LUXURY 14 2.0L TURBO 4X4 GCC 0Km

Бренд: JEEP

Brand: JEEP

الماركة: جيب

Категория: GRAND CHEROKEE

Category: GRAND CHEROKEE

الفئة: جراند شيروكي

Модель: LIMITED PLUS LUXURY

Model: LIMITED PLUS LUXURY

الموديل: ليمند بلس لكشري

Год: 2023

Year: 2023

السنة: 2023

Километров: 0 км

Kilometers: 0Km

كيلومترات: 0 كم

Двери: 4

Doors: 4 Doors

عدد الأبواب: أربعة ابواب

Цвет: Бриллиантовый Черный

Color: Diamond Black

اللون: أسود

Цилиндр: 4

Cylinder: 4 Cylinders

عدد الاسطوانات: 4 أسطوانات

Лошадиные силы: 270 HP

Horsepower: 270 HP

عدد الأحصنة: 270 حصان

Трансмиссия: Автоматическая

Transmission: Automatic

نوع النقل : نقل أوتوماتيكي

Топливо: Бензин

GCC Specifications

المواصفات الإقليمية: الخليجية

Производство: 2023

Fuel: Gasoline

نوع الوقود: بنزين

2023 JEEP GRAND CHEROKEE LIMITE PLUS LUXURY 14 2.0L TURBO 4X4 GCC 0Km

CAPRI LEATHERETTE W/AXIS II SEATS

GLOBAL BLACK/WICKER BEIGE

MIDDLE EAST EQUIPMENT GROUP

EMEA EQUIPMENT GROUP

LUXURY TECH GROUP II

SMOKER'S GROUP

220 AMP ALTERNATOR

AUX BATTERY

ADVANCED BRAKE ASSIST

ANTI-LOCK 4-WHEEL FNC DISC BRAKES

VENTILATED FRONT SEATS

CARGO COMPARTMENT COVER

REMOVABLE ASH TRAY

8-SPD AUTO 850RE TRANS (MAKE)

3.70 REAR AXLE RATIO

2.0L 14 DOHC DI TURBO ENGINE W/ ESS

LIGHT TINT SOLAR CONTROL GLASS

WINDOW SHADES, 2ND ROW, MANUAL

AUTO DIM EXTERIOR DRIVER MIRROR

RRVIEW AUTODIM DIGITAL DISPLAY MIRRO

DUAL-PANE PANORAMIC SUNROOF

PASSIVE ENTRY-FRT/RR DOORS, LIFTGATE

240 KPH PRIMARY SPEEDOMETER

RAIN SENSITIVE WINDSHIELD WIPERS

REAR BACK UP CAMERA WASHER

CIGAR LIGHTER

GPS NAVIGATION

GPS ANTENNA INPUT

ACTIVE NOISE CONTROL SYSTEM

EXT. MIRRORS W/SUPPLEMENTAL SIGNALS

EXTERIOR MIRRORS W/ARABIC LETTERING

EXTERIOR MIRRORS W/MEMORY

2023 JEEP GRAND CHEROKEE LIMITE PLUS LUXURY 14 2.0L TURBO 4X4 GCC 0Km

MEMORY STEERING COLUMN

HEATED EXTERIOR MIRRORS

GLOSS BLACK EXTERIOR MIRRORS

MANUAL FOLDING EXTERIOR MIRRORS

REAR LED FOG LAMPS

LED DAYTIME RUNNING LAMPS- LOW BEAM

PEDESTRIAN/CYCLIST EMERGENCY BRAKING

FRONT LICENSE PLATE BRACKET

EXPORT EMISSIONS

EURO STAGE 5 EMISSIONS W/EOBD 5

ENGINE OIL COOLER

HEAVY DUTY ENGINE COOLING

DIAMOND BLACK CRYSTAL P/C

ALL RADIO EQUIPPED VEHICLES

9 AMPLIFIED SPEAKERS W/SUBWOOFER

506 WATT AMPLIFIER

APPLE CARPLAY

DISASSOCIATED TOUCHSCREEN DISPLAY

WIRELESS CHARGING PAD

GOOGLE ANDROID AUTO

USB HOST FLIP

BODY COLOR SHARK FIN ANTENNA

10.1" TOUCHSCREEN DISPLAY

DIGITAL AUDIO BROADCASTING

INTEGRATED CENTER STACK RADIO

ALL R1 HIGH RADIOS

EXPORT TUNED SUSPENSION

POWER TILT/TELESCOPE STEERING COLUMN

FULL SIZE SPARE TIRE

265/50R20 PERFORMANCE A/S TIRES

2023 JEEP GRAND CHEROKEE LIMITE PLUS LUXURY 14 2.0L TURBO 4X4 GCC 0Km

PIRELLI BRAND TIRES

UCONNECT 5 NAV W 10.1" DISP(ROW+DAB)

REST OF WORLD RADIO COUNTRIES

20X8.5 MACHINED/PAINTED ALUM WHEEL

ALL ALUMINUM WHEELS

18" FULL SIZE STEEL SPARE WHEEL

SURROUND VIEW CAMERA SYSTEM

PARKSENSE FR/RR PARK ASSIST W/STOP

ARABIC LANGUAGE

INTEGRATED OFF-ROAD CAMERA

INTERSECTION COLLISION ASSIST SYSTEM

INTEGRATED VOICE COMMAND W/BLUETOOTH

ALL PARKSENSE SYSTEMS

3 ADDITIONAL GALLONS OF GAS



2023 JEEP GRAND CHEROKEE LIMITE PLUS LUXURY 14 2.0L TURBO 4X4 GCS 0Km

EURO 5

Зимний Пакет

Вентиляция и Подогрев Сидений

Рулевое Колесо с Подогревом

Боковые Зеркала с Подогревом

Электрорегулировка сидений с памятью позиций

Адаптивный круиз-контроль

Камера 360 градусов

Регулируемые режимы вождения (включая Зимний режим)

Премиум LED оптика

Панорамная Крыша

Стереосистема Alpine с 9 динамиками и сабвуфером

Система удержания в полосе

Зеркало с камерой заднего вида

Система помощи при спуске

Система экстренного торможения

Система контроля слепых зон

Система Start/Stop

Контроль скорости

Бесключевой доступ

Бесключевой старт

Дистанционный запуск двигателя

10,1-дюймовый сенсорный дисплей

Беспроводная зарядка для телефона

Задние Шторки

Система Мониторинга Слепых Зон

Apple CarPlay

Android Auto

2023 JEEP GRAND CHEROKEE LIMITE PLUS LUXURY 14 2.0L TURBO 4X4 GCC 0Kم

* الأداء:

ناقل حركة أوتوماتيكي ب 8 سرعات
عدد الأسطوانات: 4 أسطوانات
سعة المحرك: 2.0 ليتر توربو
العزم: 400 نيوتن.متر
عدد الأحصنة: 270 حصان
دفع رباعي 4X4

* المواصفات الإضافية:

OFF ROAD PAGES
رادار
فتحة سقف بانوراما
مثبت السرعة التكميلي
محدد سرعة الكتروني
نظام مكابح متقدم مع الفرامل التلقائية
نظام البطارية المزدوجة للبدء والتوقف
كاميرا بزاوية 360
نظام صوتي متقدم من Alpine
كاميرا المرآة الداخلية
خاصية تبريد وتدفئة المراتب
خاصية تدفئة المقود
خاصية تسخين المرايا الجانبية

2023 JEEP GRAND CHEROKEE LIMITE PLUS LUXURY 14 2.0L TURBO 4X4 GCC 0Km

حساسات متقدمة

التشغيل عن بعد

تثبيت مسار

خاصية تنظيف الكاميرا

الوضعيات المتعددة للقيادة

دخول بصمة

خاصية الكشف عن النقطة العمياء

مراتب كهربائية متعددة الوضعيات مع خاصية الذاكرة

شاشة تعمل باللمس قياس حجم 10.1 بوصة

اللغة عربية

نظام الملاحة وتحديد المواقع

آمر صوتي متكامل مع بلوتوث

دبّة كهرباء

مخارج طاقة كهربائية متعددة

شاحن هاتف لاسلكي امامي

ستائر خلفية

إنارة متقدمة

عازل حراري خارجي للزجاج

عازل للضجيج الخارجي

ابل كاربلاي + اندرويد أوتو

AUTOMAX®

The Boutique Of Muscle Cars, Truck Fanatics & German Automotive Experts.



نتكلم اللغة العربية

WE SPEAK ENGLISH

ON PARLE LE FRANCAIS

Nosotros hablamos español

мы говорим по-русски

biz o'zbek tilida

gaplashamiz

हम हिंदी बोलते हैं



automaxgroup.me



[automax group](https://www.youtube.com/automaxgroup)



[automax.dxb](https://www.snapchat.com/add/automax.dxb)



[Automax_LLC](https://www.telegram.com/Automax_LLC)



[+971 50 602 7200](https://www.whatsapp.com/+971506027200)



[automax.dxb](https://www.instagram.com/automax.dxb)



[automax.dxb](https://www.facebook.com/automax.dxb)



[automax.dxb](https://www.tiktok.com/automax.dxb)



[automax_dxb](https://www.twitter.com/automax_dxb)



[automax group L.L.C](https://www.linkedin.com/company/automax-group-l-l-c)

New Auto Market - Dubai - United Arab Emirates

[Directions](#)