



Jeep

GRAND CHEROKEE



Jeep



Jeep

GRAND CHEROKEE





Jeep

AUTOMAX
AUTOMAX
Tel: 04 - 3205540 / Mob: 95 277 277 07

4x4

LIMITED



Jeep

AUTOMAX
AUTOMAX.COM | TEL: (416) 220-0808 | FAX: (416) 277-2772

LIMITED

GRAND CHEROKEE







Jeep

AIRBAG

0 km/h P 92°

Key Fob
Has Left
The Vehicle

Top View

2

1

3

MUTE

MAX

REAR

OFF

1

AUX

2

12V DC



Jeep

AIRBAG

OK

ep

AG



SET+



CANC



RES



SET-

N

0 km/h P

92°F

Key Fob
has Left
the Vehicle



27 km



0 km/h P

88°F

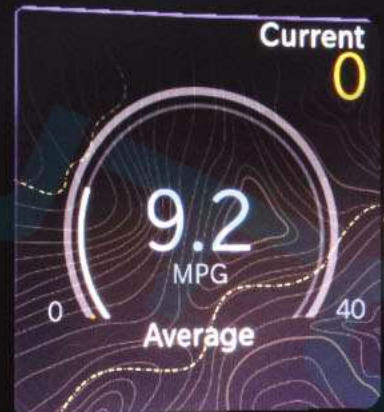

FM

FM 102

FM 102.00 MH



Press OK to Select

Hold OK to Edit

32 km



F

--

4. Off Road

0 km/h P

88°F

AUTO

Automatic Full

Time 4WD

Adapts to

Road Conditions



RPM X 1000

Terrain Status

32 km

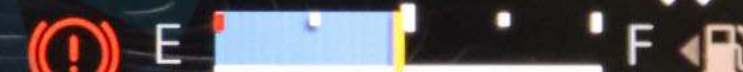

--

4. Off Road

0 km/h P

88°F

AUTO

Automatic Full

Time 4WD

Adapts to
Road Conditions



Terrain Status

32 km

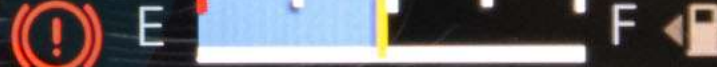

--

4. Off Road

0 km/h P

88°F

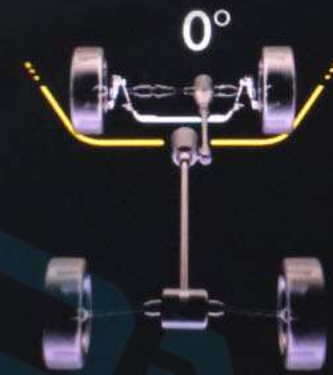

Vehicle Dynamics

32 km

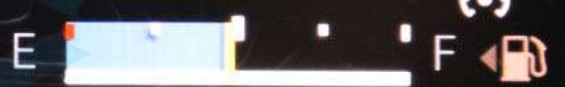
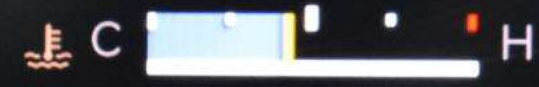

--

4. Off Road

0 km/h P

88°F



3°



0°



RPM X 1000

Pitch & Roll

32 km



E



F



4. Off Road

0 km/h P



3°



0°



RPM X 1000

Pitch & Roll

32 km

C

H



E



Низ.



98°
НАРУЖН.

4:05

FM STAR FM



Передн.

Задний

Check Entire Surroundings



Top View

Rear View

The main display area is split into two panels. The left panel, labeled 'Top View', shows a top-down perspective of a car on a road. The right panel, labeled 'Rear View', shows a rearward perspective of the same road. Hand gesture icons are overlaid on both panels, with numbers 1, 2, and 3 indicating different gestures. In the Top View, gesture 1 is a hand with fingers spread, gesture 2 is a hand with the index finger pointing, and gesture 3 is a hand with the index finger pointing and a small circle below it. In the Rear View, gesture 1 is a hand with fingers spread, gesture 2 is a hand with the index finger pointing, and gesture 3 is a hand with the index finger pointing and a small circle below it. A white arrow points upwards in the center of the Rear View panel.



LO | 36° OUT | 4:28 | FM ARABIYA | LO

Front Rear

2 2

Heat Heat

Vent Vent

1 1

Max A/C A/C Max Rear

3 3

Sync Off < 1 2 3 4 5 6 7 > Auto

Comfort

MUTE SCREEN OFF

VOL ENTER

REAR OFF AUTO

- Vehicle Dynamics **2**
- Accessory Gauges
- Pitch & Roll**
- Selec-Terrain
- Forward Facing Camera

The interface features two circular gauges. The left gauge is labeled 'Pitch' and shows a 0° reading with an upward-pointing arrow. The right gauge is labeled 'Roll' and also shows a 0° reading. Each gauge has a hand icon with a '1' and a '2' indicating touch gestures. A '3' is positioned near a central control knob. Below the gauges, the text '4WD HIGH' is displayed in orange, followed by coordinates '55°22'03" E' and '25°10'06" N', and 'Altitude -19 m'. A large 'AUTO' label is at the bottom right of the gauge area.

LO

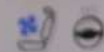

36°
OUT

4:38

FM ARABIYA



LO

Vehicle Dynamics

Accessory Gauges

Pitch & Roll

Selec-Terrain

Forward Facing Camera

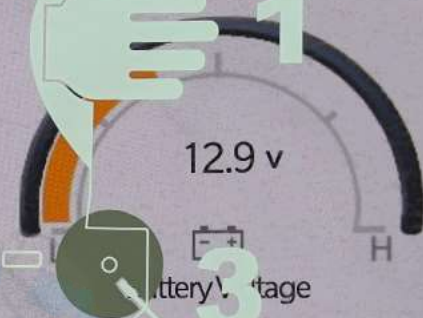
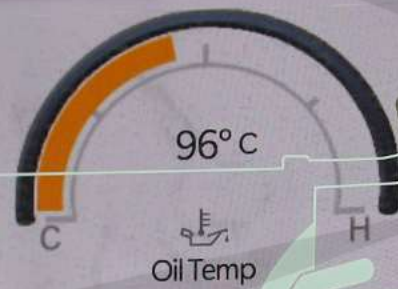

4WD
HIGH

55°22'03" E 25°10'06" N

Altitude -19 m

AUTO



Vehicle



LO



36°
OUT

4:37

FM ARABIYA



LO

Vehicle Dynamics **2**



Steering Angle:
0°



2

Accessory Gauges

Transfer Case:
4WD HIGH



1

Pitch & Roll

Selec-Terrain

Forward Facing Camera

3

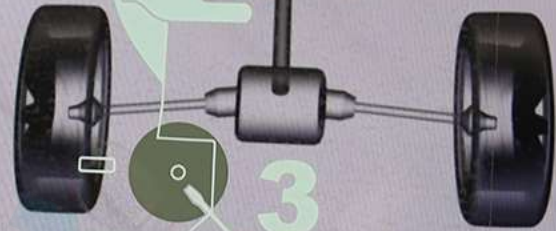

3

4WD
HIGH

55°22'03" E

25°10'06" N

Altitude -19 m

AUTO



E
▲



Vehicle



LO



36°
OUT

4:37

FM ARABIYA

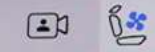

LO

Selectable Tire Fill Alert

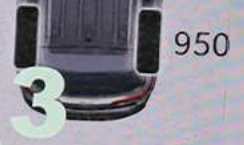
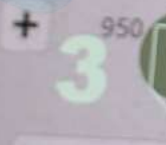

Apply and Save Preset

Presets



E
A



MUTE



LO



36°
OUT

4:30

FM ARABIYA



LO

Favorites

Recent

Categories

All

2

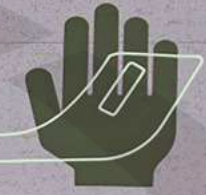
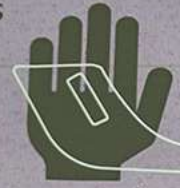

2



eco-
Coaching

1



Comfort



Off Road
Pages



1

3

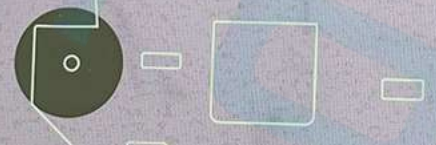

3



Apps

Низ.



98°
НАРУЖН.

4:01

FM STAR FM



Низ.

Избранные

Последние

Категории

Все

А - Я

Я - А



Автом.



Вент. водит.



Вент. пасс.



Допол.
кабель



Затемнение
зеркала



Камера
зад. вида



Камера
круг. обзо...



Комфорт



Главная



М/мед



Comfort



Nav



Тел.



Автом.



Прил.

Последние Категории Все

Vertical menu with icons and a 'Синх.' button.

Main grid of icons: Вент. водит., Вент. пасс., Допол. кабель, Камера зад. вида, Камера круг. обзо..., Комфорт.

Низ.



98°
НАРУЖН.

4:04

FM STAR FM



Низ.

Передн.

Задний



Об.

Вен



Пер. обдув

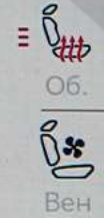
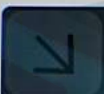

Об.

Вен

Макс. А/С

A/C

Максим.

Задний

Синхр.

Off



1

2

3

4

5

6

7



Авт.



Главная



M/мед



Comfort



Nav



Тел.



Автом.



Прил.

Низ.



98°
НАРУЖН.

4:02

FM STAR FM



Низ.

Динамика
автомобиля

Вспомог.
приборы

Попер.
перемещения

Selec-Terrain

Камера
переднего
обзора

Угол поворота
рулевого колеса:
0°

Transfer Case:
Разблокирована

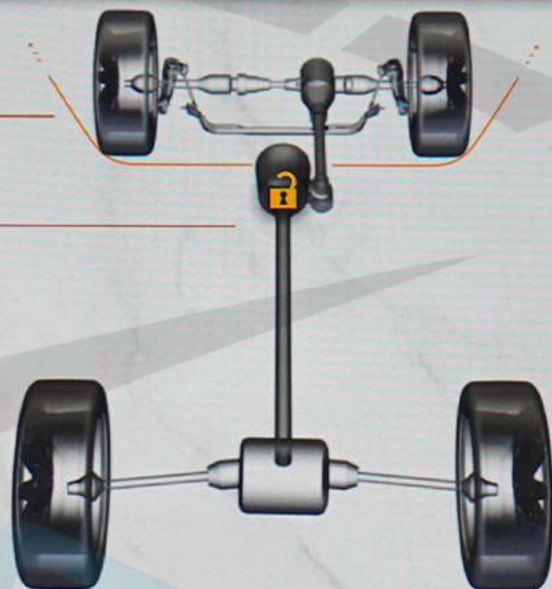

4WD HIGH

55°22'13" E

25°10'20" N

Высота -4 m

SPORT



Главная



М/мед



Comfort



Nav



Тел.



Автом.



Прил.

Низ.



98°
НАРУЖН.

4:02

FM STAR FM



Низ.

Динамика
автомобиля

Вспомог.
приборы

Попер.
перемещения

Selec-Terrain

Камера
переднего
обзора



4WD HIGH

55°22'13" E

25°10'20" N

Высота -4 m

SPORT



Главная



М/мед



Comfort

3



Nav



Тел.



Автом.



Прил.

Низ.



98°
НАРУЖН.

4:02

FM STAR FM



Низ.

Динамика
автомобиля

Вспомог.
приборы

Попер.
перемещения

Selec-Terrain

Камера
переднего
обзора



0°

Наклон

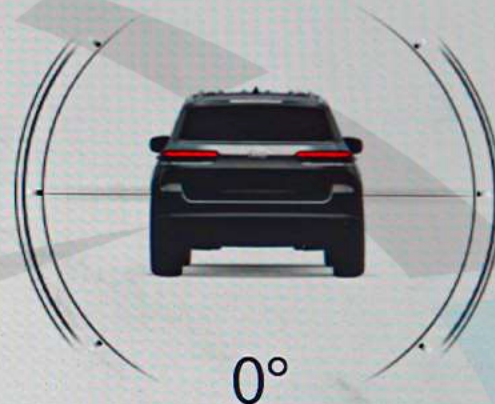

0°

Крен

4WD HIGH

55°22'13" E

25°10'20" N

Высота -4 m

SPORT



Главная



М/мед



Comfort



Nav



Тел.



Автом.



Прил.

Низ.

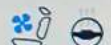

98°

НАРУЖН.

4:02

FM STAR FM



Низ.

Динамика
автомобиля

Вспомог.
приборы

Попер.
перемещения

Selec-Terrain

Камера
переднего
обзора



4WD HIGH

55°22'13" E

25°10'20" N

Высота -4 m

SPORT



Главная



М/мед



Comfort



Nav



Тел.



Автом.



Прил.

MUTE

AC

OFF

OFF

OFF

OFF

SCREEN

Низ.



98°
НАРУЖН.

4:02

FM STAR FM



Низ.

Динамика
автомобиля

Вспомог.
приборы

Попер.
перемещения

Selec-Terrain

Камера
переднего
обзора



4WD HIGH

55°22'13" E

25°10'20" N

Высота -4 m

SNOW



Главная



М/мед



Comfort



Nav



Тел.



Автом.



Прил.

MUTE



SCREEN
OFF

Низ.



98°
НАРУЖН.

4:02

FM STAR FM



Низ.

Динамика
автомобиля

Вспомог.
приборы

Попер.
перемещения

Selec-Terrain

Камера
переднего
обзора



4WD HIGH

55°22'13" E

25°10'20" N

Высота -4 m

SNOW



Главная



М/мед



Comfort



Nav



Тел.



Автом.



Прил.

MUTE



SCREEN
OFF

2 غير غير FM

1

4 أنقر للحفظ

3 أنقر للحفظ

2 سر حفظ

1 كل المُسبقة

6 شارع

بحث شارع نذ الحمر

1

OFF OFF OFF OFF OFF OFF

22° 24° خارج 7:20 97.30 FM 22°



التطبيقات المركبة الهاتف Nav Comfort الوسائط الرئيسية

MUTE SCREEN OFF



VOL TIME

22° 24° خارج ٦:٢٣ 97.30 FM 22°

ديناميكيات
المركبة

2

زاوية التوجيه
0°

ملحقات
المقاييس

انحدار و
التفاف

Selec-Terrain

الكاميرا الأمامية

4WD
HIGH

55°22'07" E 25°10'14" N

ارتفاع -23 m

SNOW

التطبيقات

المركبة

الهاتف

Nav

Comfort

الوسائط

الرئيسية

OFF OFF OFF OFF OFF

٢٢° ٢٤° خارج ٦:٢٣ 97.30 FM ٢٢°

ديناميكيات المركبة

ملحقات المقاييس

انحدار و التفاف

Selec-Terrain

الكاميرا الأمامية



4WD HIGH 55°22'07" E 25°10'14" N ارتفاع -23 m SNOW

التطبيقات

المركبة

الهاتف

Nav

Comfort

الوسائط

الرئيسية

MUTE

SCREEN

OFF OFF OFF OFF OFF OFF

٢٢° ٢٤° خارج ٦:٢٣ 97.30 FM ٢٢°

ديناميكيات المركبة 2

ملحقات المقاييس

انحدار و التفاف

Selec-Terrain

الكاميرا الأمامية

انحدار 0°

التفاف 0°

4WD HIGH 55°22'07" E 25°10'14" N ارتفاع -23 m SNOW

التطبيقات المركبة الهاتف Nav Comfort الوسائط الرئيسية

MUTE SCREEN OFF

Navigation screen menu bar with icons for Home, Media, Comfort, E A Nav (highlighted), Phone, Vehicle, and Apps.

Control panel row containing MUTE, microphone mute, fan speed, fan on/off, fan mode, fan speed, microphone mute, and SCREEN OFF buttons.

VOL knob with a power icon in the center.

Central climate control slider with a fan icon and up/down arrows.

TUNE, ENTER, SCROLL knob.

Control panel row containing MAX, REAR, OFF, fan speed, fan mode, fan speed, AUTO, A/C, and car icon buttons.

SAND/MUD
SNOW
AUTO
SPORT



P

R

FU

MAX

REAR

OFF

AUTO

A/C



12V DC

1

AUX

2



SAND/MUD
SNOW
AUTO
SPORT

P R N D



VOL REAR OFF AUX ENTER AUTO A/C

1 2 12V DC

SAND/MUD
SNOW
AUTO
SPORT

P R N D

Handbrake

Handbrake

Cup Holders



115 V AC
150 W











Control panel on the sun visor with the following buttons and features:

- Left side: Headlight control button with a headlight icon and a sliding switch.
- Center: A car icon at the top, followed by an "OFF" button with a car icon, a sliding switch, and an "ON" button with a car icon.
- Right side: Headlight control button with a headlight icon and a sliding switch.
- Bottom row: Three buttons labeled "OPEN AUTO CLOSE", "TILT VENT DOWN", and "OPEN AUTO CLOSE".
- Red "SOS" button with a telephone handset icon.









ALPINE





12V DC









Manufacturer Name	FCA US LLC		اسم الصانع
Model Year	2023	Label No	145111
Vehicle Type	FCA US LLC JEEP Grand Cherokee 3.6L SUV 4WD 4Doors		



 هيئة التقييس لدول مجلس التعاون لدول الخليج العربية GCC Standardization Organization	Fuel Type	بنزين	
	Fuel Economy	12 km/L	
	Vehicle Class	Light Truck	

إزالة أو تغطية أو إتلاف هذه البطاقة قبل البيع يعرض للملاحقة القانونية
 Removing, covering or damaging this label before sale is punishable by law







GRAND CHEROKEE

PIRELLI

SCORPION VERDE

Jeep

265/50R20 P280

DOT WWP KP7 RSC2 C222

THIS TIRE CANNOT BE USED ON VEHICLES EXCEEDING 2000 KG (4400 LBS) GVWR

MADE IN ITALY

PIRELLI

PIRELLI

PIRELLI

PIRELLI





لمشاهدة صورة السيارة بزاوية 360 درجة إضغط على الصورة أعلاه

Для просмотра автомобиля в формате 360°, пожалуйста, нажмите на фото выше.

To view the 360° degree please press on the picture above

2023 JEEP GRAND CHEROKEE LIMITED PLUS LUXURY 4X4 GCC 0Km

Бренд: JEEP

Категория: GRAND CHEROKEE

Модель: LIMITED PLUS LUXURY

Год: 2023

Километров: 0 км

Двери: 4

Цвет: Бриллиантовый Черный

Цилиндр: 6

Лошадиные силы: 290 HP

Трансмиссия: Автоматическая

Топливо: Бензин

Производство: 2023

Brand: JEEP

Category: GRAND CHEROKEE

Model: LIMITED PLUS LUXURY

Year: 2023

Kilometers: 0Km

Doors: 4 Doors

Color: Diamond Black

Cylinder: 6 Cylinders

Horsepower: 290 HP

Transmission: Automatic

GCC Specifications

Fuel: Gasoline

الماركة: جيب

الفئة: جرانند شيروكي

الموديل: ليمتد بلس لكشري

السنة: 2023

كيلومترات: 0 كم

عدد الأبواب: أربعة ابواب

اللون: أسود

عدد الاسطوانات: 6 أسطوانات

عدد الأحصنة: 290 حصان

نوع النقل : نقل أوتوماتيكي

المواصفات الإقليمية: الخليجية

نوع الوقود: بنزين

2023 JEEP GRAND CHEROKEE LIMITED PLUS LUXURY 4X4 GCC 0Km

CAPRI LEATHERETTE W/AXIS II SEATS

GLOBAL BLACK/WICKER BEIGE

MIDDLE EAST EQUIPMENT GROUP

EMEA EQUIPMENT GROUP

LUXURY TECH GROUP II

SMOKER'S GROUP

AUX BATTERY

ADVANCED BRAKE ASSIST

ANTI-LOCK 4-WHEEL FNC DISC BRAKES

VENTILATED FRONT SEATS

CARGO COMPARTMENT COVER

REMOVABLE ASH TRAY

8-SPD AUTO 8HP50 TRANS (BUY)

3.6L V6 24V VVT ENGINE UPG I W/ESS

LIGHT TINT SOLAR CONTROL GLASS

WINDOW SHADES, 2ND ROW, MANUAL

AUTO DIM EXTERIOR DRIVER MIRROR

RRVIEW AUTODIM DIGITAL DISPLAY MIRRO

DUAL-PANE PANORAMIC SUNROOF

PASSIVE ENTRY-FRT/RR DOORS, LIFTGATE

240 KPH PRIMARY SPEEDOMETER

RAIN SENSITIVE WINDSHIELD WIPERS

REAR BACK UP CAMERA WASHER

CIGAR LIGHTER

GPS NAVIGATION

GPS ANTENNA INPUT

ACTIVE NOISE CONTROL SYSTEM

EXT. MIRRORS W/SUPPLEMENTAL SIGNALS

EXTERIOR MIRRORS W/ARABIC LETTERING

EXTERIOR MIRRORS W/MEMORY

2023 JEEP GRAND CHEROKEE LIMITED PLUS LUXURY 4X4 GCC 0Km

MEMORY STEERING COLUMN

HEATED EXTERIOR MIRRORS

GLOSS BLACK EXTERIOR MIRRORS

MANUAL FOLDING EXTERIOR MIRRORS

REAR LED FOG LAMPS

LED DAYTIME RUNNING LAMPS- LOW BEAM

PEDESTRIAN/CYCLIST EMERGENCY BRAKING

FRONT LICENSE PLATE BRACKET

EXPORT EMISSIONS

EURO STAGE 6B EMISSIONS

ENGINE OIL COOLER

TRANSMISSION HEATER

DIAMOND BLACK CRYSTAL P/C

ALL RADIO EQUIPPED VEHICLES

9 AMPLIFIED SPEAKERS W/SUBWOOFER

506 WATT AMPLIFIER

APPLE CARPLAY

DISASSOCIATED TOUCHSCREEN DISPLAY

WIRELESS CHARGING PAD

GOOGLE ANDROID AUTO

USB HOST FLIP

BODY COLOR SHARK FIN ANTENNA

10.1" TOUCHSCREEN DISPLAY

DIGITAL AUDIO BROADCASTING

INTEGRATED CENTER STACK RADIO

ALL R1 HIGH RADIOS

EXPORT TUNED SUSPENSION

POWER TILT/TELESCOPE STEERING COLUMN

FULL SIZE SPARE TIRE

265/50R20 PERFORMANCE A/S TIRES

2023 JEEP GRAND CHEROKEE LIMITED PLUS LUXURY 4X4 GCC 0Km

PIRELLI BRAND TIRES

UCONNECT 5 NAV W 10.1" DISP(ROW+DAB)

REST OF WORLD RADIO COUNTRIES

20X8.5 MACHINED/PAINTED ALUM WHEEL

ALL ALUMINUM WHEELS

18" FULL SIZE STEEL SPARE WHEEL

SURROUND VIEW CAMERA SYSTEM

PARKSENSE FR/RR PARK ASSIST W/STOP

ARABIC LANGUAGE

INTEGRATED OFF-ROAD CAMERA

INTERSECTION COLLISION ASSIST SYSTEM

INTEGRATED VOICE COMMAND W/BLUETOOTH

ALL PARKSENSE SYSTEMS

3 ADDITIONAL GALLONS OF GAS



2023 JEEP GRAND CHEROKEE LIMITED PLUS LUXURY 4X4 GCC 0Km

EURO 6

Зимний Пакет

Вентиляция и Подогрев Сидений

Рулевое Колесо с Подогревом

Боковые Зеркала с Подогревом

Электрорегулировка сидений с памятью позиций

Адаптивный круиз-контроль

Камера 360 градусов

Регулируемые режимы вождения (включая Зимний режим)

Премиум LED оптика

Панорамная Крыша

Стереосистема Alpine с 9 динамиками и сабвуфером

Система удержания в полосе

Зеркало с камерой заднего вида

Система помощи при спуске

Система экстренного торможения

Система контроля слепых зон

Система Start/Stop

Контроль скорости

Бесключевой доступ

Бесключевой старт

Дистанционный запуск двигателя

10,1-дюймовый сенсорный дисплей

Беспроводная зарядка для телефона

Задние Шторки

Система Мониторинга Слепых Зон

Apple CarPlay

Android Auto

2023 JEEP GRAND CHEROKEE LIMITED PLUS LUXURY 4X4 GCC 0Kم

* الأداء:

ناقل حركة أوتوماتيكي ب 8 سرعات

عدد الأسطوانات: 6 أسطوانات

سعة المحرك: 3.6 ليتر

العزم: 348 نيوتن.متر

عدد الأحصنة: 290 حصان

دفع رباعي 4X4

* المواصفات الإضافية:

OFF ROAD PAGES

رادار

فتحة سقف بانوراما

مثبت السرعة التكميلي

محدد سرعة الكتروني

نظام مكابح متقدم مع الفرامل التلقائية

نظام البطارية المزدوجة للبدء والتوقف

كاميرا بزاوية 360

نظام صوتي متقدم من Alpine

كاميرا المرآة الداخلية

خاصية تبريد وتدفئة المراتب

خاصية تدفئة المقود

خاصية تسخين المرايا الجانبية

2023 JEEP GRAND CHEROKEE LIMITED PLUS LUXURY 4X4 GCC 0Km

حساسات متقدمة

التشغيل عن بعد

تثبيت مسار

خاصية تنظيف الكاميرا

الوضعيات المتعددة للقيادة

دخول بصمة

خاصية الكشف عن النقطة العمياء

مراتب كهربائية متعددة الوضعيات مع خاصية الذاكرة

شاشة تعمل باللمس قياس حجم 10.1 بوصة

اللغة عربية

نظام الملاحة وتحديد المواقع

آمر صوتي متكامل مع بلوتوث

دبّة كهرباء

مخارج طاقة كهربائية متعددة

شاحن هاتف لاسلكي امامي

ستائر خلفية

إنارة متقدمة

عازل حراري خارجي للزجاج

عازل للضجيج الخارجي

ابل كاربلاي + اندرويد أوتو

AUTOMAX®

The Boutique Of Muscle Cars, Truck Fanatics & German Automotive Experts.



تتکلم اللغة العربية

WE SPEAK ENGLISH

ON PARLE LE FRANCAIS

Nosotros hablamos español

мы говорим по-русски

biz o'zbek tilida

gaplashamiz

हम हिंदी बोलते हैं



automaxgroup.me



[automax group](https://www.youtube.com/automaxgroup)



[automax.dxb](https://www.snapchat.com/add/automax.dxb)



[Automax_LLC](https://www.telegram.com/Automax_LLC)



[+971 54 279 8990](https://www.whatsapp.com/+971542798990)



[automax.dxb](https://www.instagram.com/automax.dxb)



[automax.dxb](https://www.facebook.com/automax.dxb)



[automax.dxb](https://www.tiktok.com/automax.dxb)



[automax_dxb](https://www.x.com/automax_dxb)



[automax group L.L.C](https://www.linkedin.com/company/automax-group-l-l-c)

New Auto Market - Dubai - United Arab Emirates

[Directions](#)